

Figure 130

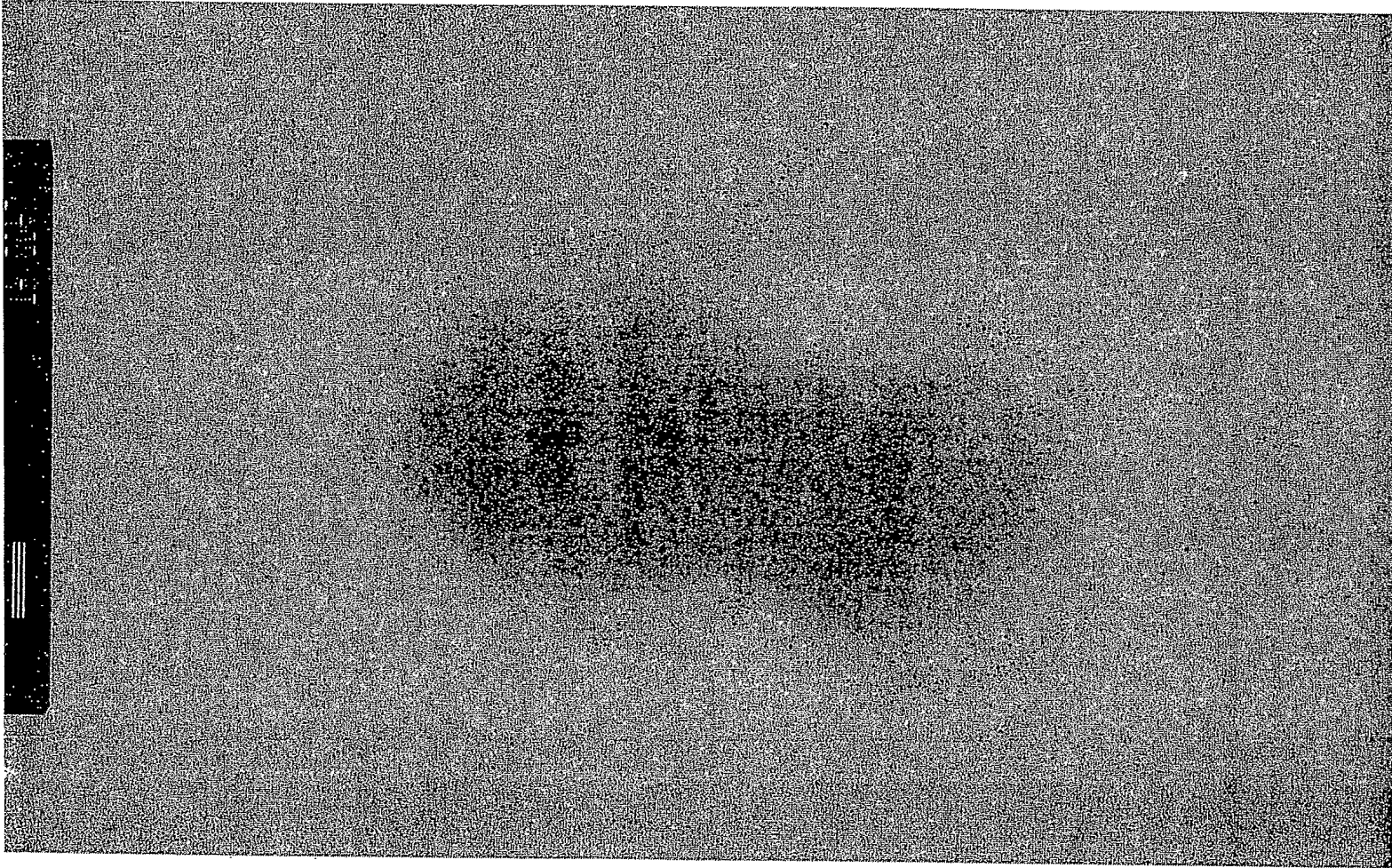
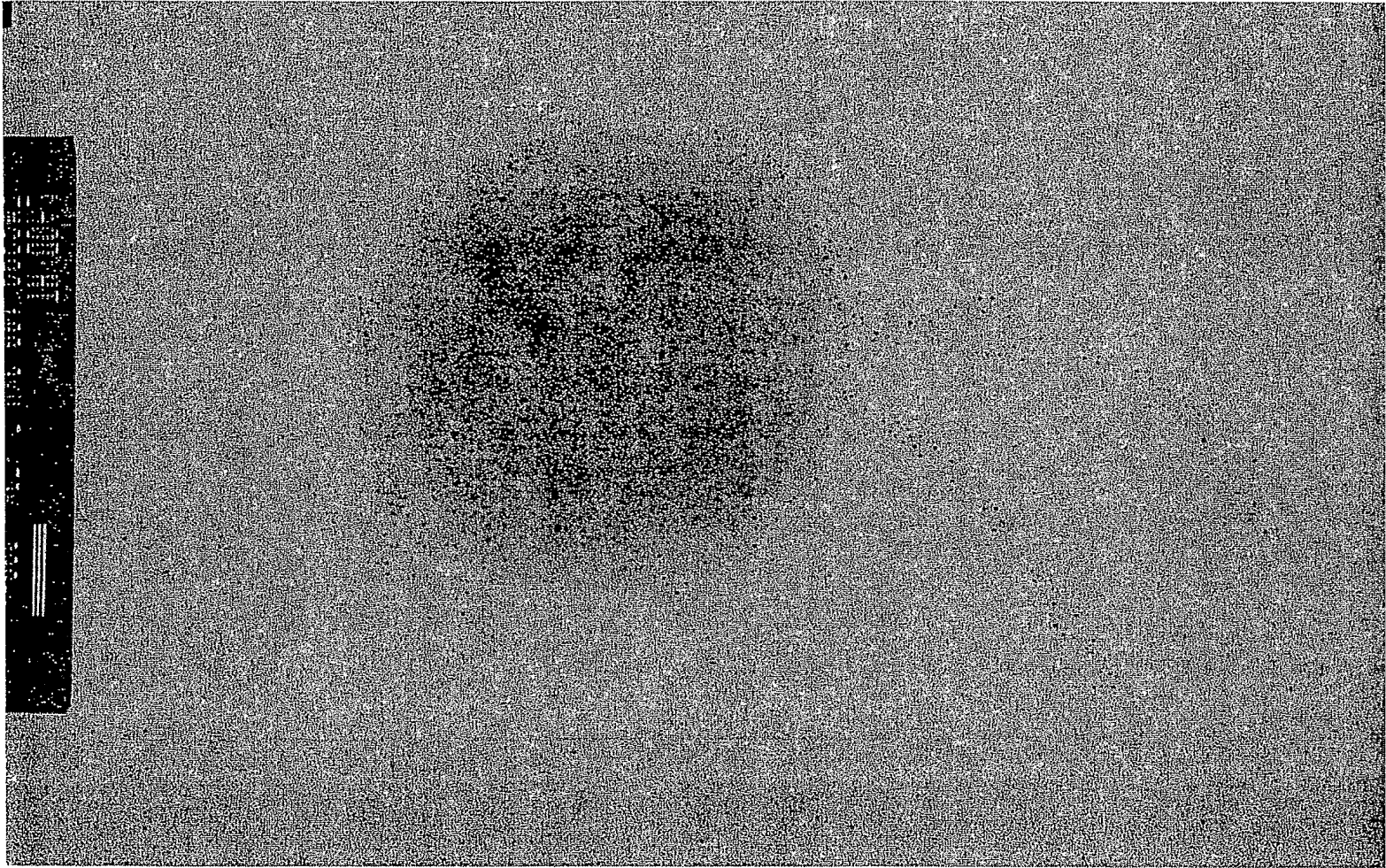

Figure 131



323/487

Figure 132



324/487

Figure 133

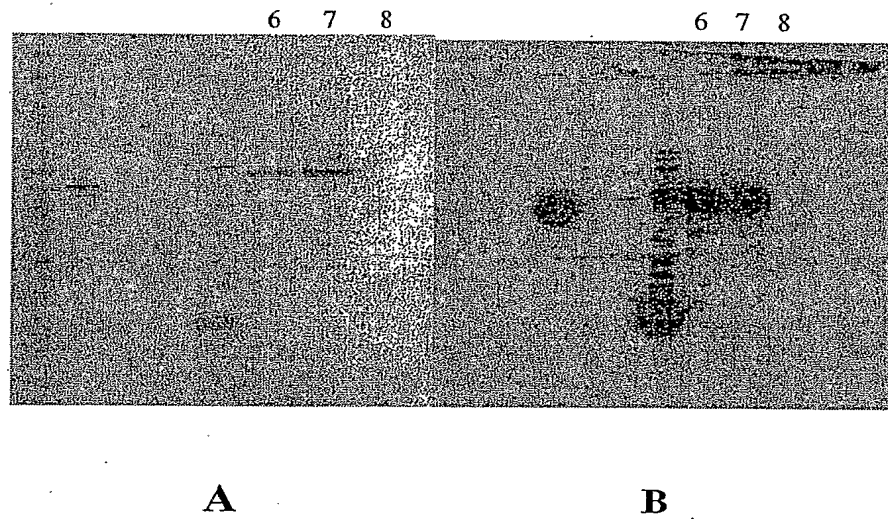
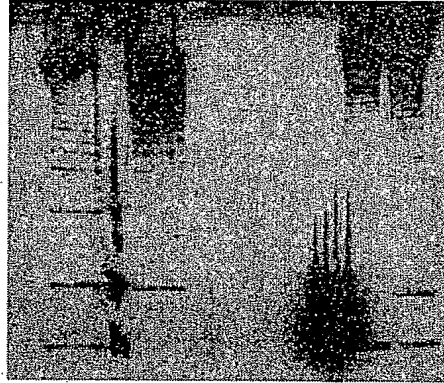

Figure 134

1 2 3 4 5 6 7 8 9 10



PCT/US05/27239 326/487

Figure 135

1 2 3 4 5 6 7 8 9 10

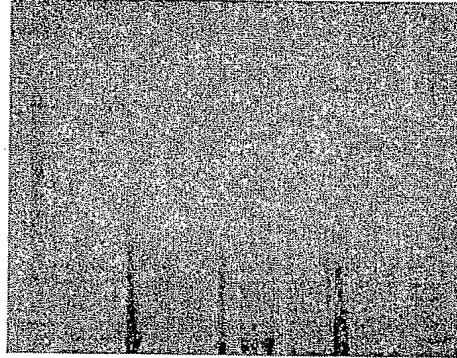

Pilus released by *Lactococcus* sonication

SONICATED

starting material
 pellet
 supernatant

1 2 3 4 5 6 7 8 9 10 11

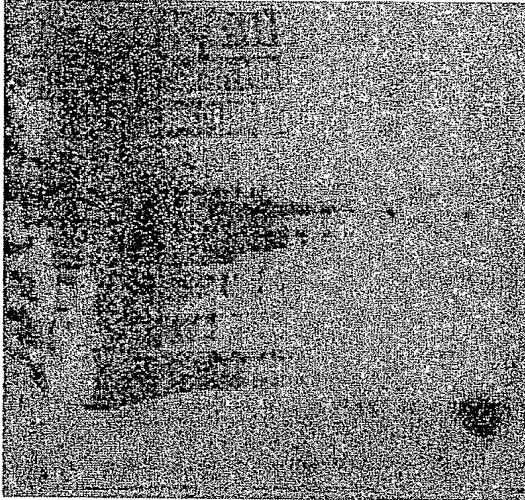

α -80

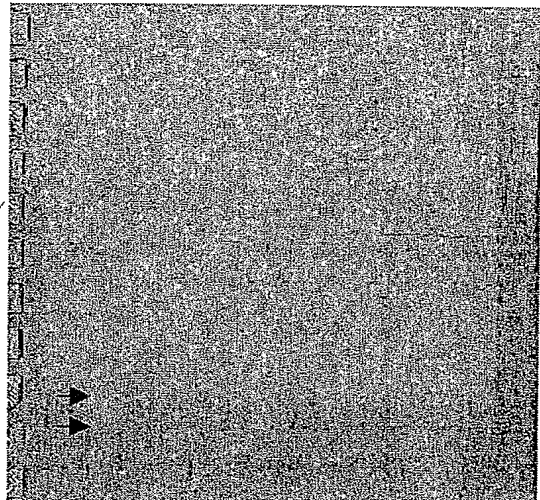

Figure 136A

1. MK
2. GBS 80 (10 ng)
3. L.lactis-AII starting material (30', 0.2 OD)
(not boiled, 0.33 OD)
4. L.lactis-AII (5', 0.33 OD)
5. L.lactis-AII (60' d, 0.33 OD)
6. L.lactis-AII (30', 0.33 OD)
7. L.lactis-AII (not boiled, 2 OD)
8. Supernatant (5', 2 OD)
9. Supernatant (30', 2 OD)
10. Supernatant (60', 2 OD)
11. Supernatant

Figure 136B

1. MK
2. L.lactis-AII (30', 0.33 OD)
3. L.lactis-AII starting material (30', 0.2 OD)
(not boiled, 0.33 OD)
4. L.lactis-AII (5', 0.33 OD)
5. L.lactis-AII (60' d, 0.33 OD)
6. L.lactis-AII (30', 0.33 OD)
7. L.lactis-AII (not boiled, 2 OD)
8. Supernatant (5', 2 OD)
9. Supernatant (30', 2 OD)
10. Supernatant (60', 2 OD)
11. Supernatant

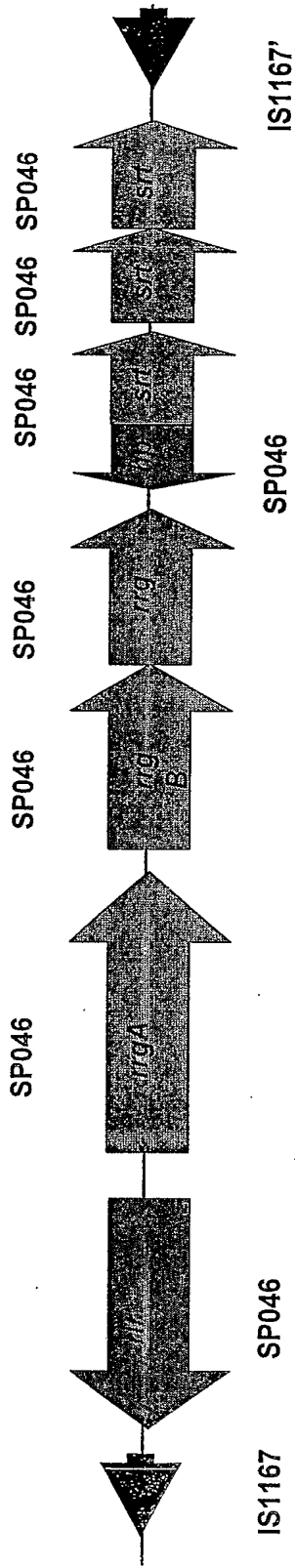

Figure 137

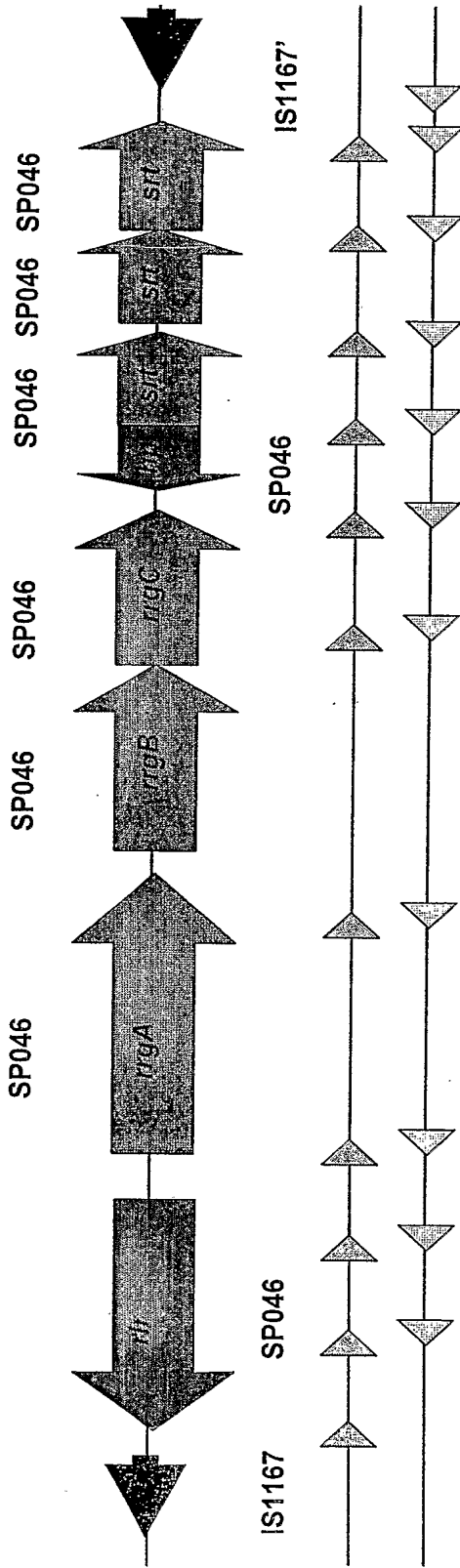
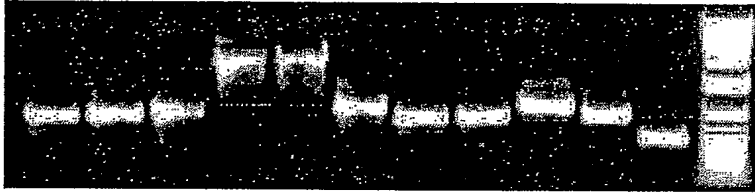

Figure 138

A



TIGR4

B

PCR product	contig_length _TIGR4	overlap
1	754	83
2	759	84
3	847	98
4	2550	99
5	2736	99
6	925	99
7	745	87
8	765	94
9	1008	94
10	802	64
11	461	

Figure 139

Figure 141A

ORF2_14CSR MLNKYIEKRITDKITILNILLDIRSIELDELSTLTSLQSKSLLSILQELQETFEELTFN
 ORF2_19AH MLNKYIEKRITDKITILNILLDIRSIELDELSTLTSLQSKSLLSILQELQETFEELTFN
 ORF2_19FTW MLNKYIEKRITDKITILNILLDIRSIELDELSTLTSLQSKSLLSILQELQETFEELTFN
 ORF2_23FP MLNKYIEKRITDKITILNILLDIRSIELDELSTLTSLQSKSLLSILQELQETFEELTFN
 ORF2_23FTW MLNKYIEKRITDKITILNILLDIRSIELDELSTLTSLQSKSLLSILQELQETFEELTFN
 ORF2_670 MLNKYIEKRITDKITILNILLDIRSIELDELSTLTSLQSKSLLSILQELQETFEELTFN
 ORF2_6BF MLNKYIEKRITDKITILNILLDIRSIELDELSTLTSLQSKSLLSILQELQETFEELTFN
 ORF2_6BSP MLNKYIEKRITDKITILNILLDIRSIELDELSTLTSLQSKSLLSILQELQETFEELTFN
 ORF2_TIGR MLNKYIEKRITDKITILNILLDIRSIELDELSTLTSLQSKSLLSILQELQETFEELTFN
 ORF2_9VSP MLNKYIEKRITDKITILNILLDIRSIELDELSTLTSLQSKSLLSILQELQETFEELTFN

ORF2_14CSR LDTQQVQLIEHSHQTNYYFHQLYNQSTILKILRFFLLQGNQSFNEFTQKEYISIATGYR
 ORF2_19AH LDTQQVQLIEHSHQTNYYFHQLYNQSTILKILRFFLLQGNQSFNEFTQKEYISIATGYR
 ORF2_19FTW LDTQQVQLIEHSHQTNYYFHQLYNQSTILKILRFFLLQGNQSFNEFTQKEYISIATGYR
 ORF2_23FP LDTQQVQLIEHSHQTNYYFHQLYNQSTILKILRFFLLQGNQSFNEFTQKEYISIATGYR
 ORF2_23FTW LDTQQVQLIEHSHQTNYYFHQLYNQSTILKILRFFLLQGNQSFNEFTQKEYISIATGYR
 ORF2_670 LDTQQVQLIEHSHQTNYYFHQLYNQSTILKILRFFLLQGNQSFNEFTQKEYISIATGYR
 ORF2_6BF LDTQQVQLIEHSHQTNYYFHQLYNQSTILKILRFFLLQGNQSFNEFTQKEYISIATGYR
 ORF2_6BSP LDTQQVQLIEHSHQTNYYFHQLYNQSTILKILRFFLLQGNQSFNEFTQKEYISIATGYR
 ORF2_TIGR LDTQQVQLIEHSHQTNYYFHQLYNQSTILKILRFFLLQGNQSFNEFTQKEYISIATGYR
 ORF2_9VSP LDTQQVQLIEHSHQTNYYFHQLYNQSTILKILRFFLLQGNQSFNEFTQKEYISIATGYR

ORF2_14CSR VRQKCGLLRSVGLDLVKNQVVGPEYRIRFLIALLOFHFHFGIEIYDLNDGSMDWVTHMIVQ
 ORF2_19AH VRQKCGLLRSVGLDLVKNQVVGPEYRIRFLIALLOFHFHFGIEIYDLNDGSMDWVTHMIVQ
 ORF2_19FTW VRQKCGLLRSVGLDLVKNQVVGPEYRIRFLIALLOFHFHFGIEIYDLNDGSMDWVTHMIVQ
 ORF2_23FP VRQKCGLLRSVGLDLVKNQVVGPEYRIRFLIALLOFHFHFGIEIYDLNDGSMDWVTHMIVQ
 ORF2_23FTW VRQKCGLLRSVGLDLVKNQVVGPEYRIRFLIALLOFHFHFGIEIYDLNDGSMDWVTHMIVQ
 ORF2_670 VRQKCGLLRSVGLDLVKNQVVGPEYRIRFLIALLOFHFHFGIEIYDLNDGSMDWVTHMIVQ
 ORF2_6BF VRQKCGLLRSVGLDLVKNQVVGPEYRIRFLIALLOFHFHFGIEIYDLNDGSMDWVTHMIVQ
 ORF2_6BSP VRQKCGLLRSVGLDLVKNQVVGPEYRIRFLIALLOFHFHFGIEIYDLNDGSMDWVTHMIVQ
 ORF2_TIGR VRQKCGLLRSVGLDLVKNQVVGPEYRIRFLIALLOFHFHFGIEIYDLNDGSMDWVTHMIVQ
 ORF2_9VSP VRQKCGLLRSVGLDLVKNQVVGPEYRIRFLIALLOFHFHFGIEIYDLNDGSMDWVTHMIVQ

ORF2_14CSR SNSQLSHELLEITPDEYVHFSILVALTWKRREFPLEFPESKEFEKLNLFMPYILMEHCQ
 ORF2_19AH SNSQLSHELLEITPDEYVHFSILVALTWKRREFPLEFPESKEFEKLNLFMPYILMEHCQ
 ORF2_19FTW SNSQLSHELLEITPDEYVHFSILVALTWKRREFPLEFPESKEFEKLNLFMPYILMEHCQ
 ORF2_23FP SNSQLSHELLEITPDEYVHFSILVALTWKRREFPLEFPESKEFEKLNLFMPYILMEHCQ
 ORF2_23FTW SNSQLSHELLEITPDEYVHFSILVALTWKRREFPLEFPESKEFEKLNLFMPYILMEHCQ
 ORF2_670 SNSQLSHELLEITPDEYVHFSILVALTWKRREFPLEFPESKEFEKLNLFMPYILMEHCQ
 ORF2_6BF SNSQLSHELLEITPDEYVHFSILVALTWKRREFPLEFPESKEFEKLNLFMPYILMEHCQ
 ORF2_6BSP SNSQLSHELLEITPDEYVHFSILVALTWKRREFPLEFPESKEFEKLNLFMPYILMEHCQ
 ORF2_TIGR SNSQLSHELLEITPDEYVHFSILVALTWKRREFPLEFPESKEFEKLNLFMPYILMEHCQ
 ORF2_9VSP SNSQLSHELLEITPDEYVHFSILVALTWKRREFPLEFPESKEFEKLNLFMPYILMEHCQ

ORF2_14CSR TYLEPHANMTFTQEELDYIFLVYCSANSSFSKDKWNQEKKTHTIQLILQHTRGKHLLSKF
 ORF2_19AH TYLEPHANMTFTQEELDYIFLVYCSANSSFSKDKWNQEKKTHTIQLILQHTRGKHLLSKF
 ORF2_19FTW TYLEPHANMTFTQEELDYIFLVYCSANSSFSKDKWNQEKKTHTIQLILQHTRGKHLLSKF
 ORF2_23FP TYLEPHANMTFTQEELDYIFLVYCSANSSFSKDKWNQEKKTHTIQLILQHTRGKHLLSKF
 ORF2_23FTW TYLEPHANMTFTQEELDYIFLVYCSANSSFSKDKWNQEKKTHTIQLILQHTRGKHLLSKF
 ORF2_670 TYLEPHANMTFTQEELDYIFLVYCSANSSFSKDKWNQEKKTHTIQLILQHTRGKHLLSKF
 ORF2_6BF TYLEPHANMTFTQEELDYIFLVYCSANSSFSKDKWNQEKKTHTIQLILQHTRGKHLLSKF
 ORF2_6BSP TYLEPHANMTFTQEELDYIFLVYCSANSSFSKDKWNQEKKTHTIQLILQHTRGKHLLSKF
 ORF2_TIGR TYLEPHANMTFTQEELDYIFLVYCSANSSFSKDKWNQEKKTHTIQLILQHTRGKHLLSKF
 ORF2_9VSP TYLEPHANMTFTQEELDYIFLVYCSANSSFSKDKWNQEKKTHTIQLILQHTRGKHLLSKF

Figure 141B

ORF2_14CSR KNILGNDISNSLSFLTALTFLTRTFLFGLQNLVPPYNYEYHYGIESDKPLYHISKAIVQE
 ORF2_19AH KNILGNDISNSLSFLTALTFLTRTFLFGLQNLVPPYNYEYHYGIESDKPLYHISKAIVQE
 ORF2_19FTW KNILGNDISNSLSFLTALTFLTRTFLFGLQNLVPPYNYEYHYGIESDKPLYHISKAIVQE
 ORF2_23FP KNILGNDISNSLSFLTALTFLTRTFLFGLQNLVPPYNYEYHYGIESDKPLYHISKAIVQE
 ORF2_23FTW KNILGNDISNSLSFLTALTFLTRTFLFGLQNLVPPYNYEYHYGIESDKPLYHISKAIVQE
 ORF2_670 KNILGNDISNSLSFLTALTFLTRTFLFGLQNLVPPYNYEYHYGIESDKPLYHISKAIVQE
 ORF2_6BF KNILGNDISNSLSFLTALTFLTRTFLFGLQNLVPPYNYEYHYGIESDKPLYHISKAIVQE
 ORF2_6BSP KNILGNDISNSLSFLTALTFLTRTFLFGLQNLVPPYNYEYHYGIESDKPLYHISKAIVQE
 ORF2_TIGR KNILGNDISNSLSFLTALTFLTRTFLFGLQNLVPPYNYEYHYGIESDKPLYHISKAIVQE
 ORF2_9VSP KNILGNDISNSLSFLTALTFLTRTFLFGLQNLVPPYNYEYHYGIESDKPLYHISKAIVQE

ORF2_14CSR WMTEQKIEGVIDQHRLYLFSLYLTETIFSSSLPAIPIFIILNNQADVNLIKSIIILRNFTDK
 ORF2_19AH WMTEQKIEGVIDQHRLYLFSLYLTETIFSSSLPAIPIFIILNNQADVNLIKSIIILRNFTDK
 ORF2_19FTW WMTEQKIEGVIDQHRLYLFSLYLTETIFSSSLPAIPIFIILNNQADVNLIKSIIILRNFTDK
 ORF2_23FP WMTEQKIEGVIDQHRLYLFSLYLTETIFSSSLPAIPIFIILNNQADVNLIKSIIILRNFTDK
 ORF2_23FTW WMTEQKIEGVIDQHRLYLFSLYLTETIFSSSLPAIPIFIILNNQADVNLIKSIIILRNFTDK
 ORF2_670 WMTEQKIEGVIDQHRLYLFSLYLTETIFSSSLPAIPIFIILNNQADVNLIKSIIILRNFTDK
 ORF2_6BF WMTEQKIEGVIDQHRLYLFSLYLTETIFSSSLPAIPIFIILNNQADVNLIKSIIILRNFTDK
 ORF2_6BSP WMTEQKIEGVIDQHRLYLFSLYLTETIFSSSLPAIPIFIILNNQADVNLIKSIIILRNFTDK
 ORF2_TIGR WMTEQKIEGVIDQHRLYLFSLYLTETIFSSSLPAIPIFIILNNQADVNLIKSIIILRNFTDK
 ORF2_9VSP WMTEQKIEGVIDQHRLYLFSLYLTETIFSSSLPAIPIFIILNNQADVNLIKSIIILRNFTDK

ORF2_14CSR VASVTGYNILISPPPSEEHLTEPLIIITTKKEYLPYVKKQYPKGKHHFLTIALDLHVSQQR
 ORF2_19AH VASVTGYNILISPPPSEEHLTEPLIIITTKKEYLPYVKKQYPKGKHHFLTIALDLHVSQQR
 ORF2_19FTW VASVTGYNILISPPPSEEHLTEPLIIITTKKEYLPYVKKQYPKGKHHFLTIALDLHVSQQR
 ORF2_23FP VASVTGYNILISPPPSEEHLTEPLIIITTKKEYLPYVKKQYPKGKHHFLTIALDLHVSQQR
 ORF2_23FTW VASVTGYNILISPPPSEEHLTEPLIIITTKKEYLPYVKKQYPKGKHHFLTIALDLHVSQQR
 ORF2_670 VASVTGYNILISPPPSEEHLTEPLIIITTKKEYLPYVKKQYPKGKHHFLTIALDLHVSQQR
 ORF2_6BF VASVTGYNILISPPPSEEHLTEPLIIITTKKEYLPYVKKQYPKGKHHFLTIALDLHVSQQR
 ORF2_6BSP VASVTGYNILISPPPSEEHLTEPLIIITTKKEYLPYVKKQYPKGKHHFLTIALDLHVSQQR
 ORF2_TIGR VASVTGYNILISPPPSEEHLTEPLIIITTKKEYLPYVKKQYPKGKHHFLTIALDLHVSQQR
 ORF2_9VSP VASVTGYNILISPPPSEEHLTEPLIIITTKKEYLPYVKKQYPKGKHHFLTIALDLHVSQQR

ORF2_14CSR LIYQTIIVDIRKEAFDKRVAMIAKKAHYLL
 ORF2_19AH LIYQTIIVDIRKEAFDKRVAMIAKKAHYLL
 ORF2_19FTW LIYQTIIVDIRKEAFDKRVAMIAKKAHYLL
 ORF2_23FP LIYQTIIVDIRKEAFDKRVAMIAKKAHYLL
 ORF2_23FTW LIYQTIIVDIRKEAFDKRVAMIAKKAHYLL
 ORF2_670 LIYQTIIVDIRKEAFDKRVAMIAKKAHYLL
 ORF2_6BF LIYQTIIVDIRKEAFDKRVAMIAKKAHYLL
 ORF2_6BSP LIYQTIIVDIRKEAFDKRVAMIAKKAHYLL
 ORF2_TIGR LIYQTIIVDIRKEAFDKRVAMIAKKAHYLL
 ORF2_9VSP LIYQTIIVDIRKEAFDKRVAMIAKKAHYLL

Figure 142B

ORF3_19AH DRTTFTAKTYNYSFLNLTSDPTDIQTIKDRIPSDAEELNKDKLQYQFATFTQKALMTAD
 ORF3_23FP DRTTFTAKTYNYSFLNLTSDPTDIQTIKDRIPSDAEELNKDKLQYQFATFTQKALMTAD
 ORF3_14CSR DRTTFTAKTYNYSFLNLTSDPTDIQTIKDRIPSDAEELNKDKLQYQFATFTQKALMTAD
 ORF3_670 DRTTFTAKTYNYSFLNLTSDPTDIQTIKDRIPSDAEELNKDKLQYQFATFTQKALMTAD
 ORF3_6BF DRTTFTAKTYNYSFLNLTSDPTDIQTIKDRIPSDAEELNKDKLQYQFATFTQKALMTAD
 ORF3_6BSP DRTTFTAKTYNYSFLNLTSDPTDIQTIKDRIPSDAEELNKDKLQYQFATFTQKALMTAD
 ORF3_19FTW DQTSFTTNTKDYSYLKLTNDKNDIVELKNKVPTAEADHDGNRLMYQFATFTQKALMKAD
 ORF3_9VSP DQTSFTTNTKDYSYLKLTNDKNDIVELKNKVPTAEADHDGNRLMYQFATFTQKALMKAD
 ORF3_23FTW DQTSFTTNTKDYSYLKLTNDKNDIVELKNKVPTAEADHDGNRLMYQFATFTQKALMKAD
 ORF3_TIGR DQTSFTTNTKDYSYLKLTNDKNDIVELKNKVPTAEADHDGNRLMYQFATFTQKALMKAD
 ::*:*:* :*:*:*:*:* ** :*:*:*:*:* : : :*****:*****:*****

ORF3_19AH DILTKQARPNSKKVIFHITDGVPTMSYPINFKYTGTTQSYRTLNNFKAKTPNSSGILLE
 ORF3_23FP DILTKQARPNSKKVIFHITDGVPTMSYPINFKYTGTTQSYRTLNNFKAKTPNSSGILLE
 ORF3_14CSR DILTKQARPNSKKVIFHITDGVPTMSYPINFKYTGTTQSYRTLNNFKAKTPNSSGILLE
 ORF3_670 DILTKQARPNSKKVIFHITDGVPTMSYPINFKYTGTTQSYRTLNNFKAKTPNSSGILLE
 ORF3_6BF DILTKQARPNSKKVIFHITDGVPTMSYPINFKYTGTTQSYRTLNNFKAKTPNSSGILLE
 ORF3_6BSP DILTKQARPNSKKVIFHITDGVPTMSYPINFKYTGTTQSYRTLNNFKAKTPNSSGILLE
 ORF3_19FTW EILTQQARQNSQKVIHITDGVPTMSYPINFNHATFAPSYQNQLNAFFSKSPNKDGILLS
 ORF3_9VSP EILTQQARQNSQKVIHITDGVPTMSYPINFNHATFAPSYQNQLNAFFSKSPNKDGILLS
 ORF3_23FTW EILTQQARQNSQKVIHITDGVPTMSYPINFNHATFAPSYQNQLNAFFSKSPNKDGILLS
 ORF3_TIGR EILTQQARQNSQKVIHITDGVPTMSYPINFNHATFAPSYQNQLNAFFSKSPNKDGILLS
 :*:*:*:* *:*:*:*:*:*:*****:*****:*****:*****:*****

ORF3_19AH DFVTSADGEHKIVRGDGEYQMFTKKPVTDQYGVHQILSITSMEQRAKLVSAGYRFGYT
 ORF3_23FP DFVTSADGEHKIVRGDGEYQMFTKKPVTDQYGVHQILSITSMEQRAKLVSAGYRFGYT
 ORF3_14CSR DFVTSADGEHKIVRGDGEYQMFTKKPVTDQYGVHQILSITSMEQRAKLVSAGYRFGYT
 ORF3_670 DFVTSADGEHKIVRGDGEYQMFTKKPVTDQYGVHQILSITSMEQRAKLVSAGYRFGYT
 ORF3_6BF DFVTSADGEHKIVRGDGEYQMFTKKPVTDQYGVHQILSITSMEQRAKLVSAGYRFGYT
 ORF3_6BSP DFVTSADGEHKIVRGDGEYQMFTKKPVTDQYGVHQILSITSMEQRAKLVSAGYRFGYT
 ORF3_19FTW DFITQATSGEHTIVRGDQSYQMFDTKTVYEK-GAPAAFPVK-PEKYSEMKAAGYAVIGD
 ORF3_9VSP DFITQATSGEHTIVRGDQSYQMFDTKTVYEK-GAPAAFPVK-PEKYSEMKAAGYAVIGD
 ORF3_23FTW DFITQATSGEHTIVRGDQSYQMFDTKTVYEK-GAPAAFPVK-PEKYSEMKAAGYAVIGD
 ORF3_TIGR DFITQATSGEHTIVRGDQSYQMFDTKTVYEK-GAPAAFPVK-PEKYSEMKAAGYAVIGD
 :* :*:*:*:*:*:***:*****:*****:*****:*****

ORF3_19AH -----DLYLYWRDSILAYPFNSSTDWITNHGDPTTWYINGNMAQDGYDVFTVGVGVNGDP
 ORF3_23FP -----DLYLYWRDSILAYPFNSSTDWITNHGDPTTWYINGNMAQDGYDVFTVGVGVNGDP
 ORF3_14CSR -----DLYLYWRDSILAYPFNSSTDWITNHGDPTTWYINGNMAQDGYDVFTVGVGVNGDP
 ORF3_670 -----DLYLYWRDSILAYPFNSSTDWITNHGDPTTWYINGNMAQDGYDVFTVGVGVNGDP
 ORF3_6BF -----DLYLYWRDSILAYPFNSSTDWITNHGDPTTWYINGNMAQDGYDVFTVGVGVNGDP
 ORF3_6BSP -----DLYLYWRDSILAYPFNSSTDWITNHGDPTTWYINGNMAQDGYDVFTVGVGVNGDP
 ORF3_19FTW PINGGYIWLNWRESILAYPFNSNTAKITNHGDPTRWYINGNIAPDGYDVFTVGIINGNDP
 ORF3_9VSP PINGGYIWLNWRESILAYPFNSNTAKITNHGDPTRWYINGNIAPDGYDVFTVGIINGNDP
 ORF3_23FTW PINGGYIWLNWRESILAYPFNSNTAKITNHGDPTRWYINGNIAPDGYDVFTVGIINGNDP
 ORF3_TIGR PINGGYIWLNWRESILAYPFNSNTAKITNHGDPTRWYINGNIAPDGYDVFTVGIINGNDP
 :*:* *:*:*:*:*:*:*****:*****:*****:*****:*****

ORF3_19AH GTDEATATRFMQSISSSPDNYTNVADPSQILQELNRYFYTIVNEKKSIENGTITDPMGEL
 ORF3_23FP GTDEATATRFMQSISSSPDNYTNVADPSQILQELNRYFYTIVNEKKSIENGTITDPMGEL
 ORF3_14CSR GTDEATATRFMQSISSSPDNYTNVADPSQILQELNRYFYTIVNEKKSIENGTITDPMGEL
 ORF3_670 GTDEATATRFMQSISSSPDNYTNVADPSQILQELNRYFYTIVNEKKSIENGTITDPMGEL
 ORF3_6BF GTDEATATRFMQSISSSPDNYTNVADPSQILQELNRYFYTIVNEKKSIENGTITDPMGEL
 ORF3_6BSP GTDEATATRFMQSISSSPDNYTNVADPSQILQELNRYFYTIVNEKKSIENGTITDPMGEL
 ORF3_19FTW GTDEATATRFMQSISSSPDNYTNVADPSQILQELNRYFYTIVNEKKSIENGTITDPMGEL
 ORF3_9VSP GTDEATATRFMQSISSSPDNYTNVADPSQILQELNRYFYTIVNEKKSIENGTITDPMGEL
 ORF3_23FTW GTDEATATRFMQSISSSPDNYTNVADPSQILQELNRYFYTIVNEKKSIENGTITDPMGEL
 ORF3_TIGR GTDEATATRFMQSISSSPDNYTNVADPSQILQELNRYFYTIVNEKKSIENGTITDPMGEL
 *****:*****:*****:*****:*****

Figure 143A

ORF4_6BF MKSINKFLTMLAALLLTASSLFSAAATVFAADNVSTAPDAVTKTLTIHKLLLEDDLKTWD
ORF4_6BSP MKSINKFLTMLAALLLTASSLFSAAATVFAADNVSTAPDAVTKTLTIHKLLLEDDLKTWD
ORF4_670 MKSINKFLTMLAALLLTASSLFSAAATVFAADNVSTAPDAVTKTLTIHKLLLEDDLKTWD
ORF4_14CSR MKSINKFLTMLAALLLTASSLFSAAATVFAADNVSTAPDAVTKTLTIHKLLLEDDLKTWD
ORF4_19AH MKSINKFLTMLAALLLTASSLFSAAATVFAADNVSTAPDAVTKTLTIHKLLLEDDLKTWD
ORF4_23FP MKSINKFLTMLAALLLTASSLFSAAATVFAADNVSTAPDAVTKTLTIHKLLLEDDLKTWD
ORF4_23FTW MKSINKFLTMLAALLLTASSLFSAAATVFAAEQK-----TKTLTVHKLLMTDQELDAWN
ORF4_19FTW MKSINKFLTMLAALLLTASSLFSAAATVFAAGTT-----TTSVTVHKLLATDGDMDKIA
ORF4_9VSP MKSINKFLTMLAALLLTASSLFSAAATVFAAGTT-----TTSVTVHKLLATDGDMDKIA
ORF4_TIGR MKSINKFLTMLAALLLTASSLFSAAATVFAAGTT-----TTSVTVHKLLATDGDMDKIA
*****:*****:***** *.:*:**** :. :.

ORF4_6BF TNGPK--GYDGTQ-----SSLKDLTGVA--EIPNVYFELQKYNLTDGKEKENLKDD-S
ORF4_6BSP TNGPK--GYDGTQ-----SSLKDLTGVA--EIPNVYFELQKYNLTDGKEKENLKDD-S
ORF4_670 TNGPK--GYDGTQ-----SSLKDLTGVA--EIPNVYFELQKYNLTDGKEKENLKDD-S
ORF4_14CSR TNGPK--GYDGTQ-----SSLKDLTGVA--EIPNVYFELQKYNLTDGKEKENLKDD-S
ORF4_19AH TNGPK--GYDGTQ-----SSLKDLTGVA--EIPNVYFELQKYNLTDGKEKENLKDD-S
ORF4_23FP TNGPK--GYDGTQ-----SSLKDLTGVA--EIPNVYFELQKYNLTDGKEKENLKDD-S
ORF4_23FTW SDAITTAGYDGSQN---FEQFKLQGVVPGVTEISGVAFELQSYTGPQKEQENLTND-A
ORF4_19FTW NELETG-NYAGNKVGVLPANAKEIAGVMFVWNTNNEIIDENGQTLGVNIDPQTFKLSGA
ORF4_9VSP NELETG-NYAGNKVGVLPANAKEIAGVMFVWNTNNEIIDENGQTLGVNIDPQTFKLSGA
ORF4_TIGR NELETG-NYAGNKVGVLPANAKEIAGVMFVWNTNNEIIDENGQTLGVNIDPQTFKLSGA
.: . * * . : . * : * * : . : : . : : : . : : . : . : . :

ORF4_6BF KWTTVHGGLTTKDGLKIETSTLKG-VYRIREDRTKTTYVGPNGQVLTGSKAVPALVTLPL
ORF4_6BSP KWTTVHGGLTTKDGLKIETSTLKG-VYRIREDRTKTTYVGPNGQVLTGSKAVPALVTLPL
ORF4_670 KWTTVHGGLTTKDGLKIETSTLKG-VYRIREDRTKTTYVGPNGQVLTGSKAVPALVTLPL
ORF4_14CSR KWTTVHGGLTTKDGLKIETSTLKG-VYRIREDRTKTTYVGPNGQVLTGSKAVPALVTLPL
ORF4_19AH KWTTVHGGLTTKDGLKIETSTLKG-VYRIREDRTKTTYVGPNGQVLTGSKAVPALVTLPL
ORF4_23FP KWTTVHGGLTTKDGLKIETSTLKG-VYRIREDRTKTTYVGPNGQVLTGSKAVPALVTLPL
ORF4_23FTW VWTAVNKGVTTETGVKFDTEVLQG-TYRLVEVRKESTYVGPNGKVLTMKAVPALITLPL
ORF4_19FTW MPATAMKKLTEAEGAKFNTANLPAAKYKIYEIHSLSYVGEDGATLTGSKAVPIEIELEPL
ORF4_9VSP MPATAMKKLTEAEGAKFNTANLPAAKYKIYEIHSLSYVGEDGATLTGSKAVPIEIELEPL
ORF4_TIGR MPATAMKKLTEAEGAKFNTANLPAAKYKIYEIHSLSYVGEDGATLTGSKAVPIEIELEPL
: : . : * * * : * * * : * : * : . : * * * : * * * * * : * * * : * * *

ORF4_6BF VNNNGTVIDAHVFPKNSYNKPVVDKRIADTLNYND-----QNGLSIGTKIPYVNTTI
ORF4_6BSP VNNNGTVIDAHVFPKNSYNKPVVDKRIADTLNYND-----QNGLSIGTKIPYVNTTI
ORF4_670 VNNNGTVIDAHVFPKNSYNKPVVDKRIADTLNYND-----QNGLSIGTKIPYVNTTI
ORF4_14CSR VNNNGTVIDAHVFPKNSYNKPVVDKRIADTLNYND-----QNGLSIGTKIPYVNTTI
ORF4_19AH VNNNGTVIDAHVFPKNSYNKPVVDKRIADTLNYND-----QNGLSIGTKIPYVNTTI
ORF4_23FP VNNNGTVIDAHVFPKNSYNKPVVDKRIADTLNYND-----QNGLSIGTKIPYVNTTI
ORF4_23FTW VNQNGVVENAHVYPKNSDKPTATKFTDAAAGFVDP-----GEKGLAIGTKVPIVTTTI
ORF4_19FTW ND----VVDHAVYPKNTEAKPKIDKDFKGANPDTPRVDKDPVNHQVGDVVEYIEIVTKI
ORF4_9VSP ND----VVDHAVYPKNTEAKPKIDKDFKGANPDTPRVDKDPVNHQVGDVVEYIEIVTKI
ORF4_TIGR ND----VVDHAVYPKNTEAKPKIDKDFKGANPDTPRVDKDPVNHQVGDVVEYIEIVTKI
: * : * * : * * : * * * : * * * : * * * : * * * : * * *

ORF4_6BF PSNATFATSFWSDMTEGLTYN-EDVTITLNNVAMDQADYEVTKGNNGFNKLT EAGLAK
ORF4_6BSP PSNATFATSFWSDMTEGLTYN-EDVTITLNNVAMDQADYEVTKGNNGFNKLT EAGLAK
ORF4_670 PSNATFATSFWSDMTEGLTYN-EDVTITLNNVAMDQADYEVTKGNNGFNKLT EAGLAK
ORF4_14CSR PSNATFATSFWSDMTEGLTYN-EDVTITLNNVAMDQADYEVTKGNNGFNKLT EAGLAK
ORF4_19AH PSNATFATSFWSDMTEGLTYN-EDVTITLNNVAMDQADYEVTKGNNGFNKLT EAGLAK
ORF4_23FP PSNATFATSFWSDMTEGLTYN-EDVTITLNNVAMDQADYEVTKGNNGFNKLT EAGLAK
ORF4_23FTW PKNSTLATAFWSDMTEGLDYN-GDVVNYNGQPLDNSHYTLEAGHNGFILKLNKGLEA
ORF4_19FTW PALANYATANWSDRMTEGLAFNKGTVKVTVDDVALEAGDYALTEVATGFDLKLTDAGLAK
ORF4_9VSP PALANYATANWSDRMTEGLAFNKGTVKVTVDDVALEAGDYALTEVATGFDLKLTDAGLAK
ORF4_TIGR PALANYATANWSDRMTEGLAFNKGTVKVTVDDVALEAGDYALTEVATGFDLKLTDAGLAK
* . . * * : * * * * * : * * * . . : . . : . . : . . * * * * * : * *

Figure 143B

ORF4_6BF INGKDADQKIQITYSATLNSLAVADI PESNDITYHYGNHQDHGNTPKPTKPN-NGQITVT
ORF4_6BSP INGKDADQKIQITYSATLNSLAVADI PESNDITYHYGNHQDHGNTPKPTKPN-NGQITVT
ORF4_670 INGKDADQKIQITYSATLNSLAVADI PESNDITYHYGNHQDHGNTPKPTKPN-NGQITVT
ORF4_14CSR INGKDADQKIQITYSATLNSLAVADI PESNDITYHYGNHQDHGNTPKPTKPN-NGQITVT
ORF4_19AH INGKDADQKIQITYSATLNSLAVADI PESNDITYHYGNHQDHGNTPKPTKPN-NGQITVT
ORF4_23FP INGKDADQKIQITYSATLNSLAVADI PESNDITYHYGNHQDHGNTPKPTKPN-NGQITVT
ORF4_23FTW INGKDAEATITLKYTATLNALAVADVPEANDVTFHYGNPNPHGNTPKPNKPK-NGELTIT
ORF4_19FTW VNDQNAEKTVKITYSATLNDKAIVEVPESNDVTFNYGNPNPHGNTPKPNKPNENGLDILT
ORF4_9VSP VNDQNAEKTVKITYSATLNDKAIVEVPESNDVTFNYGNPNPHGNTPKPNKPNENGLDILT
ORF4_TIGR VNDQNAEKTVKITYSATLNDKAIVEVPESNDVTFNYGNPNPHGNTPKPNKPNENGLDILT
.:: : : :*:**** *.:*

ORF4_6BF KTWDSQPAP---EGVKATVQLVNAKTGEKVGAP-----VELSENNWYTTWSGLDNSIEY
ORF4_6BSP KTWDSQPAP---EGVKATVQLVNAKTGEKVGAP-----VELSENNWYTTWSGLDNSIEY
ORF4_670 KTWDSQPAP---EGVKATVQLVNAKTGEKVGAP-----VELSENNWYTTWSGLDNSIEY
ORF4_14CSR KTWDSQPAP---EGVKATVQLVNAKTGEKVGAP-----VELSENNWYTTWSGLDNSIEY
ORF4_19AH KTWDSQPAP---EGVKATVQLVNAKTGEKVGAP-----VELSENNWYTTWSGLDNSIEY
ORF4_23FP KTWDSQPAP---EGVKATVQLVNAKTGEKVGAP-----VELSENNWYTTWSGLDNSIEY
ORF4_23FTW KTWADAKDAPI-AGVEVTFDLVNAQTGEVVKVPGHETGIVLNQTNNTFTATGLDNNTTEY
ORF4_19FTW KTWVDATGAPI PAGAEATFDLVNAQTGKVVQTV-----TLTDDKNTVTVNGLDKNTTEY
ORF4_9VSP KTWVDATGAPI PAGAEATFDLVNAQTGKVVQTV-----TLTDDKNTVTVNGLDKNTTEY
ORF4_TIGR KTWVDATGAPI PAGAEATFDLVNAQTGKVVQTV-----TLTDDKNTVTVNGLDKNTTEY
*** . *.:*

ORF4_6BF K-VEEEYNGYSAEY-TVESKGLGVKNWKDNNPAPINPEEPRVKTYGKKFVKVDQKDRLL
ORF4_6BSP K-VEEEYNGYSAEY-TVESKGLGVKNWKDNNPAPINPEEPRVKTYGKKFVKVDQKDRLL
ORF4_670 K-VEEEYNGYSAEY-TVESKGLGVKNWKDNNPAPINPEEPRVKTYGKKFVKVDQKDRLL
ORF4_14CSR K-VEEEYNGYSAEY-TVESKGLGVKNWKDNNPAPINPEEPRVKTYGKKFVKVDQKDRLL
ORF4_19AH K-VEEEYNGYSAEY-TVESKGLGVKNWKDNNPAPINPEEPRVKTYGKKFVKVDQKDRLL
ORF4_23FP K-VEEEYNGYSAEY-TVESKGLGVKNWKDNNPAPINPEEPRVKTYGKKFVKVDQKDRLL
ORF4_23FTW KFVERTIKGYSADYQITITETGKIAVKNWKDENPEPPEEPRVKTYGKKFVKVDQKDRLL
ORF4_19FTW KFVERSIKYSADYQEIITTAGI IAVKNWKDENPKPLDPTEPKVVTYGKKFVKVNDKDNRL
ORF4_9VSP KFVERSIKYSADYQEIITTAGI IAVKNWKDENPKPLDPTEPKVVTYGKKFVKVNDKDNRL
ORF4_TIGR KFVERSIKYSADYQEIITTAGI IAVKNWKDENPKPLDPTEPKVVTYGKKFVKVNDKDNRL
* * * . *:*****: : *.:*

ORF4_6BF ENAQFVVKKADSN-KYIAFKSTAQQAADEKAAATAKQKLDAAVAAY---TNAADKQAAQA
ORF4_6BSP ENAQFVVKKADSN-KYIAFKSTAQQAADEKAAATAKQKLDAAVAAY---TNAADKQAAQA
ORF4_670 ENAQFVVKKADSN-KYIAFKSTAQQAADEKAAATAKQKLDAAVAAY---TNAADKQAAQA
ORF4_14CSR ENAQFVVKKADSN-KYIAFKSTAQQAADEKAAATAKQKLDAAVAAY---TNAADKQAAQA
ORF4_19AH ENAQFVVKKADSN-KYIAFKSTAQQAADEKAAATAKQKLDAAVAAY---TNAADKQAAQA
ORF4_23FP ENAQFVVKKADSN-KYIAFKSTAQQAADEKAAATAKQKLDAAVAAY---TNAADKQAAQA
ORF4_23FTW KEAQFVVKNEQG--KYLALKSAAQAVNEKAAAEAKQALDAAIAAY---TNAADKNAQA
ORF4_19FTW AGAEFVIANADNAGQYLARKADKVSQEEKQLVVTTKDALDRAVAAYNALTAQQQTQOEKE
ORF4_9VSP AGAEFVIANADNAGQYLARKADKVSQEEKQLVVTTKDALDRAVAAYNALTAQQQTQOEKE
ORF4_TIGR AGAEFVIANADNAGQYLARKADKVSQEEKQLVVTTKDALDRAVAAYNALTAQQQTQOEKE
.:: : : . *:*: * : . : : : . . :*: * * :*:*** * : : : :

ORF4_6BF LVDQAQQEYNVAYKEAKFGYVEVAGKDE--AMVLTSTNDGQFQISGLAAGT
ORF4_6BSP LVDQAQQEYNVAYKEAKFGYVEVAGKDE--AMVLTSTNDGQFQISGLAAGT
ORF4_670 LVDQAQQEYNVAYKEAKFGYVEVAGKDE--AMVLTSTNDGQFQISGLAAGT
ORF4_14CSR LVDQAQQEYNVAYKEAKFGYVEVAGKDE--AMVLTSTNDGQFQISGLAAGT
ORF4_19AH LVDQAQQEYNVAYKEAKFGYVEVAGKDE--AMVLTSTNDGQFQISGLAAGT
ORF4_23FP LVDQAQQEYNVAYKEAKFGYVEVAGKDE--AMVLTSTNDGQFQISGLAAGT
ORF4_23FTW VVDAAQKTYNDNYRAARFGYVEVERKED--ALVLTSTNDGQFQISGLAAGS
ORF4_19FTW KVDKAQAAYNAAVIAANNAFEWVADKDNENNVKLVSDAQGRFEITGLLAGT
ORF4_9VSP KVDKAQAAYNAAVIAANNAFEWVADKDNENNVKLVSDAQGRFEITGLLAGT
ORF4_TIGR KVDKAQAAYNAAVIAANNAFEWVADKDNENNVKLVSDAQGRFEITGLLAGT
* * * * * * . : : * * : : . : * . : : * : * : * : * : * : * : * : * : * : *

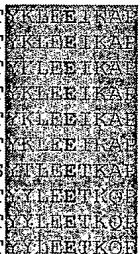

Figure 143C

ORF4_6BF	AKIDD-VEFVVGAGSWNQ--EFNYLKDVQKNDATKVVNKKITIPOTGGIGTIIIFAV
ORF4_6BSP	AKIDD-VEFVVGAGSWNQ--EFNYLKDVQKNDATKVVNKKITIPOTGGIGTIIIFAV
ORF4_670	AKIDD-VEFVVGAGSWNQ--EFNYLKDVQKNDATKVVNKKITIPOTGGIGTIIIFAV
ORF4_14CSR	AKIDD-VEFVVGAGSWNQ--EFNYLKDVQKNDATKVVNKKITIPOTGGIGTIIIFAV
ORF4_19AH	AKIDD-VEFVVGAGSWNQ--EFNYLKDVQKNDATKVVNKKITIPOTGGIGTIIIFAV
ORF4_23FP	AKIDD-VEFVVGAGSWNQ--EFNYLKDVQKNDATKVVNKKITIPOTGGIGTIIIFAV
ORF4_23FTW	AKLGD-VKFEVGAGSWNQ--DFNYLKDVQKNDATKVVNKKITIPOTGGIGTIIIFAV
ORF4_19FTW	ALLTSRQKFEVTATSYSATGQGIETAGSGKDDATKVVNKKITIPOTGGIGTIIIFAV
ORF4_9VSP	ALLTSRQKFEVTATSYSATGQGIETAGSGKDDATKVVNKKITIPOTGGIGTIIIFAV
ORF4_TIGR	ALLTSRQKFEVTATSYSATGQGIETAGSGKDDATKVVNKKITIPOTGGIGTIIIFAV

: : . :* * * * : . : :* . * :*****

ORF4_6BF	AGAAIMGIAYVYVKNKDEDQLA
ORF4_6BSP	AGAAIMGIAYVYVKNKDEDQLA
ORF4_670	AGAAIMGIAYVYVKNKDEDQLA
ORF4_14CSR	AGAAIMGIAYVYVKNKDEDQLA
ORF4_19AH	AGAAIMGIAYVYVKNKDEDQLA
ORF4_23FP	AGAVIMGIAYVYVKNKDEDQLA
ORF4_23FTW	AGAVIMGIAYVYVKNKDEDQLA
ORF4_19FTW	AGAVIMGIAYVYVKNKDEDQLA
ORF4_9VSP	AGAVIMGIAYVYVKNKDEDQLA
ORF4_TIGR	AGAAIMGIAYVYVKNKDEDQLA

*** . *****

PCT/US2005/027239

Figure 144A

```

ORF5_6BSP -----MTMQMKQKMSRIFFVMALCFSLVWGAHAVQAQEDHTLVLQLENYQEV
ORF5_TIGR -----MTMQMKQKMSRIFFVMALCFSLVWGAHAVQAQEDHTLVLQLENYQEV
ORF5_6BF -----MTMQMKQKMSRIFFVMALCFSLVWGAHAVQAQEDHTLVLQLENYQEV
ORF5_670 -----MTMQMKQKMSRIFFVMALCFSLVWGAHAVQAQEDHTLVLQLENYQEV
ORF5_19AH -----MTMQMKQKMSRIFFVMALCFSLVWGAHAVQAQEDHTLVLQLENYQEV
ORF5_14CSR -----MTMQMKQKMSRIFFVMALCFSLVWGAHAVQAQEDHTLVLQLENYQEV
ORF5_19FTW -----MTMQMKQKMSRIFFVMALCFSLVWGAHAVQAQEDHTLVLQLENYQEV
ORF5_23FTW -----MTMQMKQKMSRIFFVMALCFSLVWGAHAVQAQEDHTLVLQLENYQEV
ORF5_9VSP -----MTMQMKQKMSRIFFVMALCFSLVWGAHAVQAQEDHTLVLQLENYQEV
ORF5_23FP -----MTMQMKQKMSRIFFVMALCFSLVWGAHAVQAQEDHTLVLQLENYQEV

```

```

ORF5_6BSP VSQLP SRDGHRLQVWKLDDSYSDRRVQIVRDLHSW DENKLSSEFKKTSFEMTFLENQIEV
ORF5_TIGR VSQLP SRDGHRLQVWKLDDSYSDRRVQIVRDLHSW DENKLSSEFKKTSFEMTFLENQIEV
ORF5_6BF VSQLP SRDGHRLQVWKLDDSYSDRRVQIVRDLHSW DENKLSSEFKKTSFEMTFLENQIEV
ORF5_670 VSQLP SRDGHRLQVWKLDDSYSDRRVQIVRDLHSW DENKLSSEFKKTSFEMTFLENQIEV
ORF5_19AH VSQLP SRDGHRLQVWKLDDSYSDRRVQIVRDLHSW DENKLSSEFKKTSFEMTFLENQIEV
ORF5_14CSR VSQLP SRDGHRLQVWKLDDSYSDRRVQIVRDLHSW DENKLSSEFKKTSFEMTFLENQIEV
ORF5_19FTW VSQLP SRDGHRLQVWKLDDSYSDRRVQIVRDLHSW DENKLSSEFKKTSFEMTFLENQIEV
ORF5_23FTW VSQLP SRDGHRLQVWKLDDSYSDRRVQIVRDLHSW DENKLSSEFKKTSFEMTFLENQIEV
ORF5_9VSP VSQLP SRDGHRLQVWKLDDSYSDRRVQIVRDLHSW DENKLSSEFKKTSFEMTFLENQIEV
ORF5_23FP VSQLP SRDGHRLQVWKLDDSYSDRRVQIVRDLHSW DENKLSSEFKKTSFEMTFLENQIEV

```

```

ORF5_6BSP SHIPNGLYYVRSIIQTDVAVSYPAEFLFEMTDQTVPLVIVAKKTDMTTKVKLIKVDQDH
ORF5_TIGR SHIPNGLYYVRSIIQTDVAVSYPAEFLFEMTDQTVPLVIVAKKTDMTTKVKLIKVDQDH
ORF5_6BF SHIPNGLYYVRSIIQTDVAVSYPAEFLFEMTDQTVPLVIVAKKTDMTTKVKLIKVDQDH
ORF5_670 SHIPNGLYYVRSIIQTDVAVSYPAEFLFEMTDQTVPLVIVAKKTDMTTKVKLIKVDQDH
ORF5_19AH SHIPNGLYYVRSIIQTDVAVSYPAEFLFEMTDQTVPLVIVAKKTDMTTKVKLIKVDQDH
ORF5_14CSR SHIPNGLYYVRSIIQTDVAVSYPAEFLFEMTDQTVPLVIVAKKTDMTTKVKLIKVDQDH
ORF5_19FTW SHIPNGLYYVRSIIQTDVAVSYPAEFLFEMTDQTVPLVIVAKKTDMTTKVKLIKVDQDH
ORF5_23FTW SHIPNGLYYVRSIIQTDVAVSYPAEFLFEMTDQTVPLVIVAKKTDMTTKVKLIKVDQDH
ORF5_9VSP SHIPNGLYYVRSIIQTDVAVSYPAEFLFEMTDQTVPLVIVAKKTDMTTKVKLIKVDQDH
ORF5_23FP SHIPNGLYYVRSIIQTDVAVSYPAEFLFEMTDQTVPLVIVAKKTDMTTKVKLIKVDQDH

```

```

ORF5_6BSP NRLEGVGFKLVSVARDGSEKEVPLIGEYRYS SSGQVGR TLYTDKNGEIVFVNLPLGNYRF
ORF5_TIGR NRLEGVGFKLVSVARDVSEKEVPLIGEYRYS SSGQVGR TLYTDKNGEIVFVNLPLGNYRF
ORF5_6BF NRLEGVGFKLVSVARDGSEKEVPLIGEYRYS SSGQVGR TLYTDKNGEIVFVNLPLGNYRF
ORF5_670 NRLEGVGFKLVSVARDGSEKEVPLIGEYRYS SSGQVGR TLYTDKNGEIVFVNLPLGNYRF
ORF5_19AH NRLEGVGFKLVSVARDGSEKEVPLIGEYRYS SSGQVGR TLYTDKNGEIVFVNLPLGNYRF
ORF5_14CSR NRLEGVGFKLVSVARDGSEKEVPLIGEYRYS SSGQVGR TLYTDKNGEIVFVNLPLGNYRF
ORF5_19FTW NRLEGVGFKLVSVARDGSEKEVPLIGEYRYS SSGQVGR TLYTDKNGEIVFVNLPLGTYRF
ORF5_23FTW NRLEGVGFKLVSVARDGSEKEVPLIGEYRYS SSGQVGR TLYTDKNGEIVFVNLPLGTYRF
ORF5_9VSP NRLEGVGFKLVSVARDGSEKEVPLIGEYRYS SSGQVGR TLYTDKNGEIVFVNLPLGTYRF
ORF5_23FP NRLEGVGFKLVSVARDGSEKEVPLIGEYRYS SSGQVGR TLYTDKNGEIVFVNLPLGTYRF

```

```

ORF5_6BSP KEVEPLAGYAVTTLDTDVQLVDHQLVTTITVVNQKLRGNVDFMKVDGRTNTSLQGAMFKV
ORF5_TIGR KEVEPLAGYAVTTLDTDVQLVDHQLVTTITVVNQKLRGNVDFMKVDGRTNTSLQGAMFKV
ORF5_6BF KEVEPLAGYAVTTLDTDVQLVDHQLVTTITVVNQKLRGNVDFMKVDGRTNTSLQGAMFKV
ORF5_670 KEVEPLAGYAVTTLDTDVQLVDHQLVTTITVVNQKLRGNVDFMKVDGRTNTSLQGAMFKV
ORF5_19AH KEVEPLAGYAVTTLDTDVQLVDHQLVTTITVVNQKLRGNVDFMKVDGRTNTSLQGAMFKV
ORF5_14CSR KEVEPLAGYAVTTLDTDVQLVDHQLVTTITVVNQKLRGNVDFMKVDGRTNTSLQGAMFKV
ORF5_19FTW KEVEPLAGYAVTTLDTDVQLVDHQLVTTITVVNQKLRGNVDFMKVDGRTNTSLQGAMFKV
ORF5_23FTW KEVEPLAGYAVTTLDTDVQLVDHQLVTTITVVNQKLRGNVDFMKVDGRTNTSLQGAMFKV
ORF5_9VSP KEVEPLAGYAVTTLDTDVQLVDHQLVTTITVVNQKLRGNVDFMKVDGRTNTSLQGAMFKV
ORF5_23FP KEVEPLAGYAVTTLDTDVQLVDHQLVTTITVVNQKLRGNVDFMKVDGRTNTSLQGAMFKV

```

Figure 144B

ORF5_6BSP	MKEESGHYTPVLQNGKEVVVTS	SGKDGRFRVEGLE	YGT	WELQAPFC	VQLTSPVSFTI
ORF5_TIGR	MKEESGHYTPVLQNGKEVVVTS	SGKDGRFRVEGLE	YGT	WELQAPFC	VQLTSPVSFTI
ORF5_6BF	MKEESGHYTPVLQNGKEVVVTS	SGKDGRFRVEGLE	YGT	WELQAPFC	VQLTSPVSFTI
ORF5_670	MKEESGHYTPVLQNGKEVVVTS	SGKDGRFRVEGLE	YGT	WELQAPFC	VQLTSPVSFTI
ORF5_19AH	MKEESGHYTPVLQNGKEVVVTS	SGKDGRFRVEGLE	YGT	WELQAPFC	VQLTSPVSFTI
ORF5_14CSR	MKEESGHYTPVLQNGKEVVVTS	SGKDGRFRVEGLE	YGT	WELQAPFC	VQLTSPVSFTI
ORF5_19FTW	MKEENGHYTPVLQNGKEVVVTS	SGKDGRFRVEGLE	YGT	WELQAPFC	VQLTSPVSFTI
ORF5_23FTW	MKEENGHYTPVLQNGKEVVVTS	SGKDGRFRVEGLE	YGT	WELQAPFC	VQLTSPVSFTI
ORF5_9VSP	MKEENGHYTPVLQNGKEVVVTS	SGKDGRFRVEGLE	YGT	WELQAPFC	VQLTSPVSFTI
ORF5_23FP	MKEENGHYTPVLQNGKEVVVTS	SGKDGRFRVEGLE	YGT	WELQAPFC	VQLTSPVSFTI

****.*****:*****

ORF5_6BSP	GKDTRKELVTVVKNNKRPRI	DVPDTG	EETLYILMLVA	ILLFGSGY	LT	TKKPNN
ORF5_TIGR	GKDTRKELVTVVKNNKRPRI	DVPDTG	EETLYILMLVA	ILLFGSGY	LT	TKKPNN
ORF5_6BF	GKDTRKELVTVVKNNKRPRI	DVPDTG	EETLYILMLVA	ILLFGSGY	LT	TKKPNN
ORF5_670	GKDTRKELVTVVKNNKRPRI	DVPDTG	EETLYILMLVA	ILLFGSGY	LT	TKKPNN
ORF5_19AH	GKDTRKELVTVVKNNKRPRI	DVPDTG	EETLYILMLVA	ILLFGSGY	LT	TKKPNN
ORF5_14CSR	GKDTRKELVTVVKNNKRPRI	DVPDTG	EETLYILMLVA	ILLFGSGY	LT	TKKPNN
ORF5_19FTW	GKDTRKELVTVVKNNKRPRI	DVPDTG	EETLYILMLVA	ILLFGSGY	LT	TKKTNN
ORF5_23FTW	GKDTRKELVTVVKNNKRPRI	DVPDTG	EETLYILMLVA	ILLFGSGY	LT	TKKTNN
ORF5_9VSP	GKDTRKELVTVVKNNKRPRI	DVPDTG	EETLYILMLVA	ILLFGSGY	LT	TKKTNN
ORF5_23FP	GKDTRKELVTVVKNNKRPRI	DVPDTG	EETLYILMLVA	ILLFGSGY	LT	TKKTNN

*****. **

Figure 145A

ORF6_23FTW MLIKMKVTKKQKRNNLLLGVVFFIGMAVMAYPLVSRLYYRVE SNQOIADFDKEKATLDEA
 ORF6_TIGR MLIKMKVTKKQKRNNLLLGVVFFIGMAVMAYPLVSRLYYRVE SNQOIADFDKEKATLDEA
 ORF6_6BSP MLIKMKVTKKQKRNNLLLGVVFFIGMAVMAYPLVSRLYYRVE SNQOIADFDKEKATLDEA
 ORF6_6BF MLIKMKVTKKQKRNNLLLGVVFFIGMAVMAYPLVSRLYYRVE SNQOIADFDKEKATLDEA
 ORF6_670 MLIKMKVTKKQKRNNLLLGVVFFIGMAVMAYPLVSRLYYRVE SNQOIADFDKEKATLDEA
 ORF6_19AH MLIKMKVTKKQKRNNLLLGVVFFIGMAVMAYPLVSRLYYRVE SNQOIADFDKEKATLDEA
 ORF6_14CSR MLIKMKVTKKQKRNNLLLGVVFFIGMAVMAYPLVSRLYYRVE SNQOIADFDKEKATLDEA
 ORF6_23FP MLIKMAKTKKQKRNNLLLGVVFFIGIAVMAYPLVSRLYYRVE SNQOIADFDKEKATLDEA
 ORF6_9VSP MLIKMAKTKKQKRNNLLLGVVFFIGIAVMAYPLVSRLYYRVE SNQOIADFDKEKATLDEA
 ORF6_19FTW MLIKMAKTKKQKRNNLLLGVVFFIGMAVMAYPLVSRLYYRVE SNQOIADFDKEKATLDEA

ORF6_23FTW DIDERMKLAQAFNDSLNNVSGDPWSEEMKKKGRAEYARMLEIHERMGHVEIPVIDVDLP
 ORF6_TIGR DIDERMKLAQAFNDSLNNVSGDPWSEEMKKKGRAEYARMLEIHERMGHVEIPVIDVDLP
 ORF6_6BSP DIDERMKLAQAFNDSLNNVSGDPWSEEMKKKGRAEYARMLEIHERMGHVEIPVIDVDLP
 ORF6_6BF DIDERMKLAQAFNDSLNNVSGDPWSEEMKKKGRAEYARMLEIHERMGHVEIPVIDVDLP
 ORF6_670 DIDERMKLAQAFNDSLNNVSGDPWSEEMKKKGRAEYARMLEIHERMGHVEIPVIDVDLP
 ORF6_19AH DIDERMKLAQAFNDSLNNVSGDPWSEEMKKKGRAEYARMLEIHERMGHVEIPVIDVDLP
 ORF6_14CSR DIDERMKLAQAFNDSLNNVSGDPWSEEMKKKGRAEYARMLEIHERMGHVEIPVIDVDLP
 ORF6_23FP DIDERMKLAQAFNDSLNNVSGDPWSEEMKKKGRAEYARMLEIHERMGHVEIPVIDVDLP
 ORF6_9VSP DIDERMKLAQAFNDSLNNVSGDPWSEEMKKKGRAEYARMLEIHERMGHVEIPVIDVDLP
 ORF6_19FTW DIDERMKLAQAFNDSLNNVSGDPWSEEMKKKGRAEYARMLEIHERMGHVEIPVIDVDLP

ORF6_23FTW VYAGTAEV LQQGAGLEG TSLPIGGNSTHAVITAHTGLPTAKMFTDLTKLVGDKFYVH
 ORF6_TIGR VYAGTAEV LQQGAGLEG TSLPIGGNSTHAVITAHTGLPTAKMFTDLTKLVGDKFYVH
 ORF6_6BSP VYAGTAEV LQQGAGLEG TSLPIGGNSTHAVITAHTGLPTAKMFTDLTKLVGDKFYVH
 ORF6_6BF VYAGTAEV LQQGAGLEG TSLPIGGNSTHAVITAHTGLPTAKMFTDLTKLVGDKFYVH
 ORF6_670 VYAGTAEV LQQGAGLEG TSLPIGGNSTHAVITAHTGLPTAKMFTDLTKLVGDKFYVH
 ORF6_19AH VYAGTAEV LQQGAGLEG TSLPIGGNSTHAVITAHTGLPTAKMFTDLTKLVGDKFYVH
 ORF6_14CSR VYAGTAEV LQQGAGLEG TSLPIGGNSTHAVITAHTGLPTAKMFTDLTKLVGDKFYVH
 ORF6_23FP VYAGTAEV LQQGAGLEG TSLPIGGNSTHAVITAHTGLPTAKMFTDLTKLVGDKFYVH
 ORF6_9VSP VYAGTAEV LQQGAGLEG TSLPIGGNSTHAVITAHTGLPTAKMFTDLTKLVGDKFYVH
 ORF6_19FTW VYAGTAEV LQQGAGLEG TSLPIGGNSTHAVITAHTGLPTAKMFTDLTKLVGDKFYVH

ORF6_23FTW NIKEVMAYQVDQVKVIEPTNFDDLLIVPGHDYVTLTCTPYMINTHRLVLRGHRIPYVAE
 ORF6_TIGR NIKEVMAYQVDQVKVIEPTNFDDLLIVPGHDYVTLTCTPYMINTHRLVLRGHRIPYVAE
 ORF6_6BSP NIKEVMAYQVDQVKVIEPTNFDDLLIVPGHDYVTLTCTPYMINTHRLVLRGHRIPYVAE
 ORF6_6BF NIKEVMAYQVDQVKVIEPTNFDDLLIVPGHDYVTLTCTPYMINTHRLVLRGHRIPYVAE
 ORF6_670 NIKEVMAYQVDQVKVIEPTNFDDLLIVPGHDYVTLTCTPYMINTHRLVLRGHRIPYVAE
 ORF6_19AH NIKEVMAYQVDQVKVIEPTNFDDLLIVPGHDYVTLTCTPYMINTHRLVLRGHRIPYVAE
 ORF6_14CSR NIKEVMAYQVDQVKVIEPTNFDDLLIVPGHDYVTLTCTPYMINTHRLVLRGHRIPYVAE
 ORF6_23FP NIKEVMAYQVDQVKVIEPTNFDDLLIVPGHDYVTLTCTPYMINTHRLVLRGHRIPYVAE
 ORF6_9VSP NIKEVMAYQVDQVKVIEPTNFDDLLIVPGHDYVTLTCTPYMINTHRLVLRGHRIPYVAE
 ORF6_19FTW NIKEVMAYQVDQVKVIEPTNFDDLLIVPGHDYVTLTCTPYMINTHRLVLRGHRIPYVAE

ORF6_23FTW VEEEFIAANKLSHLYRYLFYVAVGLIVILLWIIRRLRKKKKQPEKALKALKAARKEVKVE
 ORF6_TIGR VEEEFIAANKLSHLYRYLFYVAVGLIVILLWIIRRLRKKKKQPEKALKALKAARKEVKVE
 ORF6_6BSP VEEEFIAANKLSHLYRYLFYVAVGLIVILLWIIRRLRKKKKQPEKALKALKAARKEVKVE
 ORF6_6BF VEEEFIAANKLSHLYRYLFYVAVGLIVILLWIIRRLRKKKKQPEKALKALKAARKEVKVE
 ORF6_670 VEEEFIAANKLSHLYRYLFYVAVGLIVILLWIIRRLRKKKKQPEKALKALKAARKEVKVE
 ORF6_19AH VEEEFIAANKLSHLYRYLFYVAVGLIVILLWIIRRLRKKKKQPEKALKALKAARKEVKVE
 ORF6_14CSR VEEEFIAANKLSHLYRYLFYVAVGLIVILLWIIRRLRKKKKQPEKALKALKAARKEVKVE
 ORF6_23FP VEEEFIAANKLSHLYRYLFYVAVGLIVILLWIIRRLRKKKKQSERALKALKEATKEVKVE
 ORF6_9VSP VEEEFIAANKLSHLYRYLFYVAVGLIVILLWIIRRLRKKKKQSERALKALKEATKEVKVE
 ORF6_19FTW VEEEFIAANKLSHLYRYLFYVAVGLIVILLWIIRRLRKKKKQSERALKALKEATKEVKVE

Figure 145B

ORF6_23FTW	DGQQ
ORF6_TIGR	DGQQ
ORF6_6BSP	DGQQ
ORF6_6BF	DGQQ
ORF6_670	DGQQ
ORF6_19AH	DGQQ
ORF6_14CSR	DGQQ
ORF6_23FP	DE--
ORF6_9VSP	DE--
ORF6_19FTW	DE-

Figure 147

ORF8_14CSR MSKAKLQKLLGYLLMLVALVIPVYCFGQMVLSLQSLGQVKGHEIFSESVTADS YQEQLQRS L
ORF8_19AH MSKAKLQKLLGYLLMLVALVIPVYCFGQMVLSLQSLGQVKGHEIFSESVTADS YQEQLQRS L
ORF8_23FTW MSKAKLQKLLGYLLMLVALVIPVYCFGQMVLSLQSLGQVKGHEIFSESVTADS YQEQLQRS L
ORF8_670 MSKAKLQKLLGYLLMLVALVIPVYCFGQMVLSLQSLGQVKGHEIFSESVTADS YQEQLQRS L
ORF8_6BF MSKAKLQKLLGYLLMLVALVIPVYCFGQMVLSLQSLGQVKGHEIFSESVTADS YQEQLQRS L
ORF8_6BSP MSKAKLQKLLGYLLMLVALVIPVYCFGQMVLSLQSLGQVKGHEIFSESVTADS YQEQLQRS L
ORF8_19FTW MSRTKLRALLGYLLMLVACLIPYICFGQMVLSLQSLGQVKGHATFVKSMPTTEMYQEQQNHS L
ORF8_23FP MSRTKLRALLGYLLMLVACLIPYICFGQMVLSLQSLGQVKGHATFVKSMPTTEMYQEQQNHS L
ORF8_9VSP MSRTKLRALLGYLLMLVACLIPYICFGQMVLSLQSLGQVKGHATFVKSMPTTEMYQEQQNHS L
ORF8_TIGR MSRTKLRALLGYLLMLVACLIPYICFGQMVLSLQSLGQVKGHATFVKSMPTTEMYQEQQNHS L
::*: *** :*:***** * :*:*: ***** :**

ORF8_14CSR DYNQR LDSQNRIVDPFLAEGYEVNYQVSDDPDAVYGYLSIPSL EIMEPVYLGADYHHLAM
ORF8_19AH DYNQR LDSQNRIVDPFLAEGYEVNYQVSDDPDAVYGYLSIPSL EIMEPVYLGADYHHLAM
ORF8_23FTW DYNQR LDSQNRIVDPFLAEGYEVNYQVSDDPDAVYGYLSIPSL EIMEPVYLGADYHHLAM
ORF8_670 DYNQR LDSQNRIVDPFLAEGYEVNYQVSDDPDAVYGYLSIPSL EIMEPVYLGADYHHLAM
ORF8_6BF DYNQR LDSQNRIVDPFLAEGYEVNYQVSDDPDAVYGYLSIPSL EIMEPVYLGADYHHLAM
ORF8_6BSP DYNQR LDSQNRIVDPFLAEGYEVNYQVSDDPDAVYGYLSIPSL EIMEPVYLGADYHHLAM
ORF8_19FTW AYNQR L ASQNRIVDPFLAEGYEVNYQVSDDPDAVYGYLSIPSL EIMEPVYLGADYHHLGM
ORF8_23FP AYNQR L ASQNRIVDPFLAEGYEVNYQVSDDPDAVYGYLSIPSL EIMEPVYLGADYHHLGM
ORF8_9VSP AYNQR L ASQNRIVDPFLAEGYEVNYQVSDDPDAVYGYLSIPSL EIMEPVYLGADYHHLGM
ORF8_TIGR AYNQR L ASQNRIVDPFLAEGYEVNYQVSDDPDAVYGYLSIPSL EIMEPVYLGADYHHLGM
***** ***** *

ORF8_14CSR GLAHVDGTPLPVEGKGIRSVIAGHRAEP SHVFFRHL DQLKVG DALYYDNGQEIVEYQMM D
ORF8_19AH GLAHVDGTPLPVEGKGIRSVIAGHRAEP SHVFFRHL DQLKVG DALYYDNGQEIVEYQMM D
ORF8_23FTW GLAHVDGTPLPVEGKGIRSVIAGHRAEP SHVFFRHL DQLKVG DALYYDNGQEIVEYQMM D
ORF8_670 GLAHVDGTPLPVEGKGIRSVIAGHRAEP SHVFFRHL DQLKVG DALYYDNGQEIVEYQMM D
ORF8_6BF GLAHVDGTPLPVEGKGIRSVIAGHRAEP SHVFFRHL DQLKVG DALYYDNGQEIVEYQMM D
ORF8_6BSP GLAHVDGTPLPVEGKGIRSVIAGHRAEP SHVFFRHL DQLKVG DALYYDNGQEIVEYQMM D
ORF8_19FTW GLAHVDGTPLPLDGTGIRSVIAGHRAEP SHVFFRHL DQLKVG DALYYDNGQEIVEYQMM D
ORF8_23FP GLAHVDGTPLPLDGTGIRSVIAGHRAEP SHVFFRHL DQLKVG DALYYDNGQEIVEYQMM D
ORF8_9VSP GLAHVDGTPLPLDGTGIRSVIAGHRAEP SHVFFRHL DQLKVG DALYYDNGQEIVEYQMM D
ORF8_TIGR GLAHVDGTPLPLDGTGIRSVIAGHRAEP SHVFFRHL DQLKVG DALYYDNGQEIVEYQMM D
***** :* .*****

ORF8_14CSR TEIILPSEWEKLESVSSKNIMTLITCDPIPTFNKRLLVNFERVAVYQKSDPQTAAVARVA
ORF8_19AH TEIILPSEWEKLESVSSKNIMTLITCDPIPTFNKRLLVNFERVAVYQKSDPQTAAVARVA
ORF8_23FTW TEIILPSEWEKLESVSSKNIMTLITCDPIPTFNKRLLVNFERVAVYQKSDPQTAAVARVA
ORF8_670 TEIILPSEWEKLESVSSKNIMTLITCDPIPTFNKRLLVNFERVAVYQKSDPQTAAVARVA
ORF8_6BF TEIILPSEWEKLESVSSKNIMTLITCDPIPTFNKRLLVNFERVAVYQKSDPQTAAVARVA
ORF8_6BSP TEIILPSEWEKLESVSSKNIMTLITCDPIPTFNKRLLVNFERVAVYQKSDPQTAAVARVA
ORF8_19FTW TEIILPSEWEKLESVSSKNIMTLITCDPIPTFNKRLLVNFERVAVYQKSDPQTAAVARVA
ORF8_23FP TEIILPSEWEKLESVSSKNIMTLITCDPIPTFNKRLLVNFERVAVYQKSDPQTAAVARVA
ORF8_9VSP TEIILPSEWEKLESVSSKNIMTLITCDPIPTFNKRLLVNFERVAVYQKSDPQTAAVARVA
ORF8_TIGR TEIILPSEWEKLESVSSKNIMTLITCDPIPTFNKRLLVNFERVAVYQKSDPQTAAVARVA

ORF8_14CSR FTKEGQSVSRVATSQWLYRGLVVLAF LGILFVLWKLARLLRGK
ORF8_19AH FTKEGQSVSRVATSQWLYRGLVVLAF LGILFVLWKLARLLRGK
ORF8_23FTW FTKEGQSVSRVATSQWLYRGLVVLAF LGILFVLWKLARLLRGK
ORF8_670 FTKEGQSVSRVATSQWLYRGLVVLAF LGILFVLWKLARLLRGK
ORF8_6BF FTKEGQSVSRVATSQWLYRGLVVLAF LGILFVLWKLARLLRGK
ORF8_6BSP FTKEGQSVSRVATSQWLYRGLVVLAF LGILFVLWKLARLLRGK
ORF8_19FTW FTKEGQSVSRVATSQWLYRGLVVLAF LGILFVLWKLARLLRGK
ORF8_23FP FTKEGQSVSRVATSQWLYRGLVVLAF LGILFVLWKLARLLRGK
ORF8_9VSP FTKEGQSVSRVATSQWLYRGLVVLAF LGILFVLWKLARLLRGK
ORF8_TIGR FTKEGQSVSRVATSQWLYRGLVVLAF LGILFVLWKLARLLRGK

PCT/US05/27239 346/487

RrgA, LPXTG

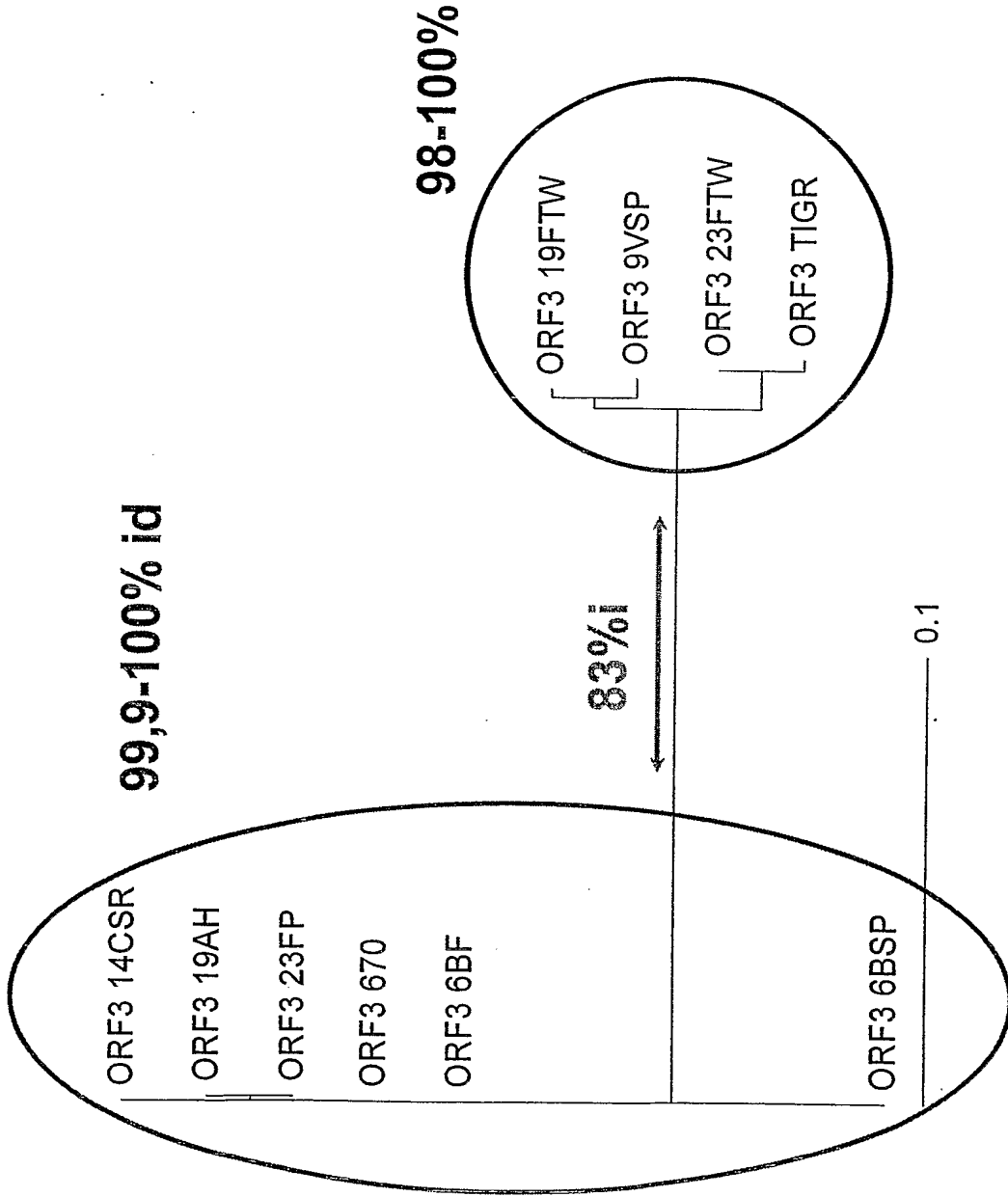

Figure 148

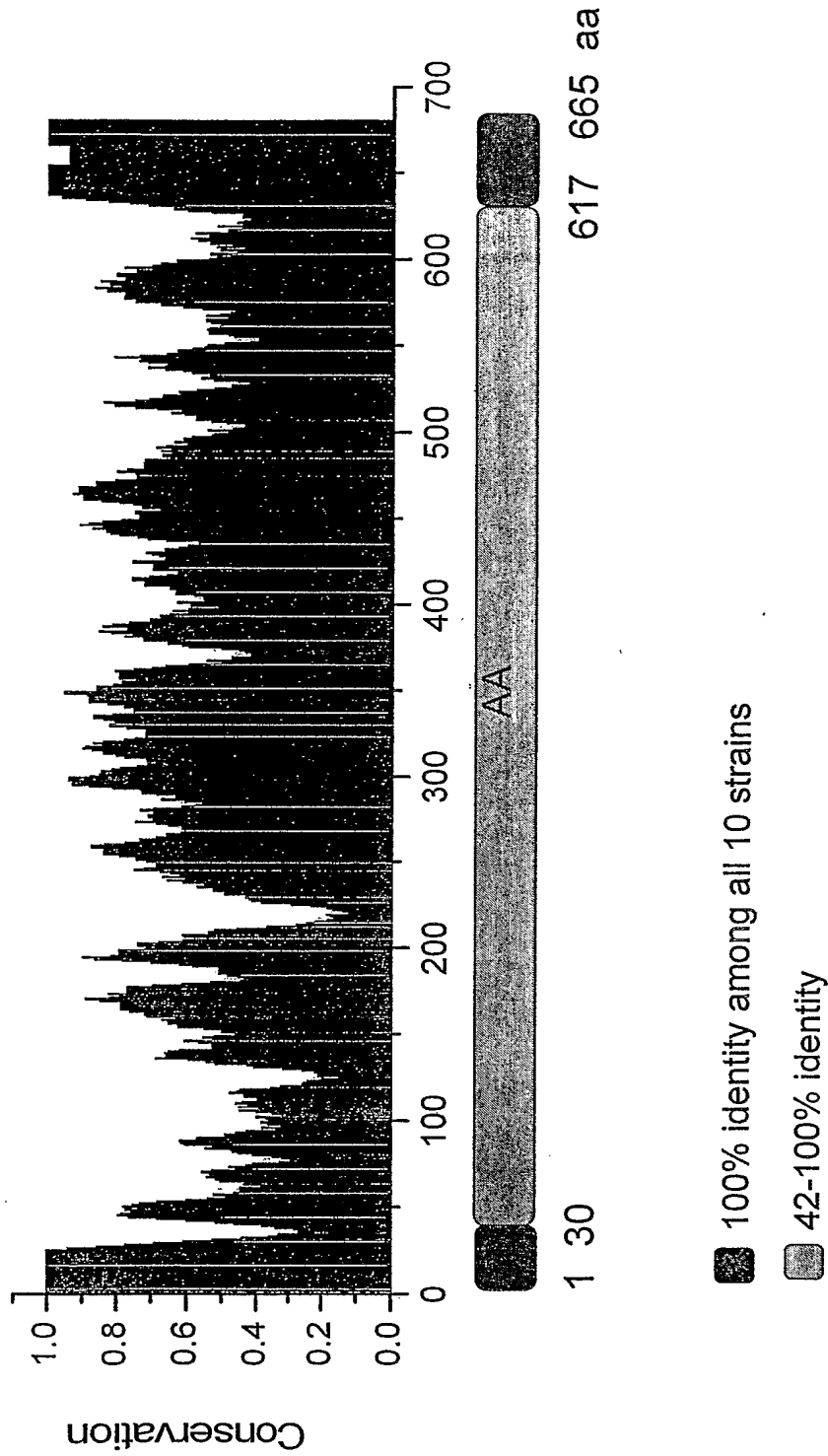

Figure 149

A

MLNRETHMKKVRKIFQKAVAGLCCISQLTAFSSIVALA*ETPETS PAIGKVVIKETGEGGALLGDAVFELKN
 NTDGTTVSRTEAQTGEAIFSNIKPGTYTLTEAQPVPVGYKPKSTKQWTVVEKNGRRTTVQGEQVENREE
 ALSDQYPQGTGTYPDVQTPYQIIKVDGSEKNGQHKALNPNPYERVPEGTLSKRIVQVNNLDDNQYGIEL
 TVSGKTVYEQDKSVPLDVVILLDNSMSNIRKNARRAERAGEATRSIDKITSSENRVVALVITYAS
 TIFDGTFTVEKGVADKNGKRLNDSLFWNYDQTSFTTNTKDYSLKLTNDKNDIVELKNKVPTEAEDHD
 GNRLMYQFGATFTQKALMKADEILTQOARQNSQKVIFHITDGVPTMSYPINFNHATFAPSYQNQLNA
 FFSKSPNKDGILLSDFITQATSGEHTIVRGDQSYQMFTDKTVYEKGAPAAFPVKPEKYSEMKAAGYAVI
 GDPINGGYIWLNWRESILAYPENSNTAKITNHGDPTRWYYNGNIAPDGYDVFTVGIGINGDPPGTDEATA
 TSEMQSISSKPENYTNVTDTTKILEQLNR YFHTIVTEKKSIE NGTITDPMGELIDLQLGTDGRFPADYTL
 TANDGSRLENGQAVGGPQNDGGLLKNKAKVLYDTTEKRIRVTGLYLGTEDEKVTLTYNVRLNDEFVSNKFYD
 TNGRTTLHPKEVEQNTVRFDPKIRDV RKYP EITISKEKLLGDIEFIKVNKNNDKKPLRGA VFSLQKQHPDYP
 DIYG AIDQNGTYQNVRTGEDGKLT FKNLSDGKYRLFENSEPAGYKPVQNKPIVAFQIVNGEVRDVTSIVPQ
 DIPAGYEFTNDKHYYITNEP IPPKREYPR TGGIGMLPFY LIGCMM MMGGVLLYTRKHP

B

5' cgggatcc-gaa-acg-cct-gaa-acc-agt 5' 24mer, 54 %G+C, Tm 62

*Bam*HI

3' ccgctcgag-aat-agg-ttc-att-ggt 3' 27mer, 52 %G+C, Tm 61.6

*Xho*I

Figure 150

A.



B.

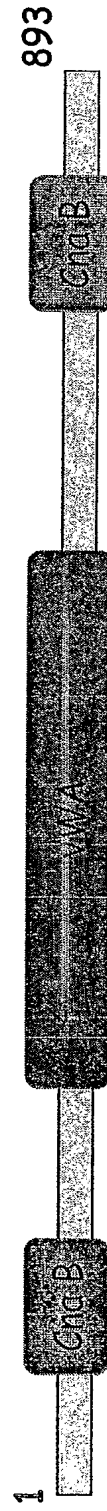
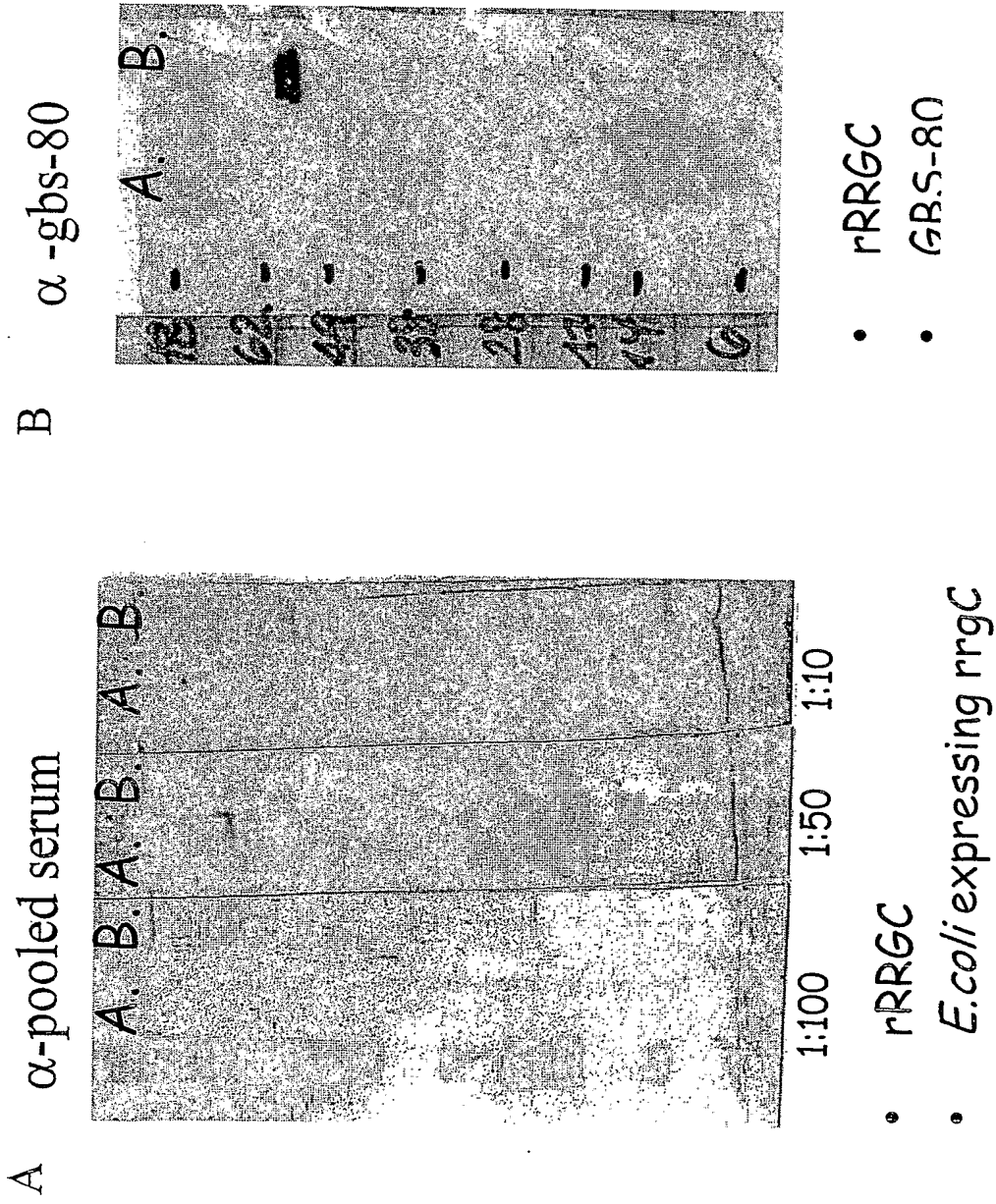

Figure 151

PCT/US05/27239 350/487

Figure 152



PCT/US05/07239

351/487

A

MKSINKFLTMLAALLLTASSLF* AATVFAAGTTTTSVTVHKLLATDGDMDKIANELETGNYAGNKVGVLP
 NAKELAGVMFVWVWNTNNEIIDENGTGVLGNIDPQTFKLSGAMPATAMKKLTEAEGAKFNTANLPAAKYKIY
 EHSLSYVGEDGATLTGSKAVPIEIELPLNDVVDVDAHVYPKNTAKPKIDKDFKGANPDTPRVDKDTPVNHQV
 GDVVEYEVTKIPALANYATANWSDRMTEGLAFNKGTVKTVDDVALEAGDYALTEVATGFDLKLTDAGLAK
 VNDQNAEKTIVKITYSATLNDKAIIVEVPESNDVTFNYGNNPDHGTTPKNKPNENGDILTITKTWVDATGAPIP
 AGAEATFDLVNAQTGKVVQTVTLTDDKNTVTVNGLDKNTEYKFVRSIKGYSADYQEITTA GEIAVKNNWKD
 ENPKPLDPTEPKVVTYGKKFVKVNDKDNRLA GAEFVIANADNAGQYLARKADKVSQEEKQLVVTTKDALDRAV
 AAYNALTAQQQTQQEKEKVDKAQAAYNAAVLAANNAFEWVADKDNENVVVKLVSDAQGRFEITGLLAGTY
 YLEETKQPAGYALLTSRQKFEVTATSYSATGQGIEYTAGSGKDDATKVVNKKIIPQTGGIGTIFAVAGAAI
 MGIAYVYVYKNNKDEQLA

B

5' cgggatcc-gct-gca-aca-gtt-ttt 3' 23mer, 52.2% G+C, Tm 60.6
*Bam*HI
 5' ccgctc:gag-agt-gat-ttt-ttt-gtt-gac 3' 26mer, 44.4% G+C, Tm 61.7
*Xho*I

Figure 153

PCT/US2005/027239 352/487

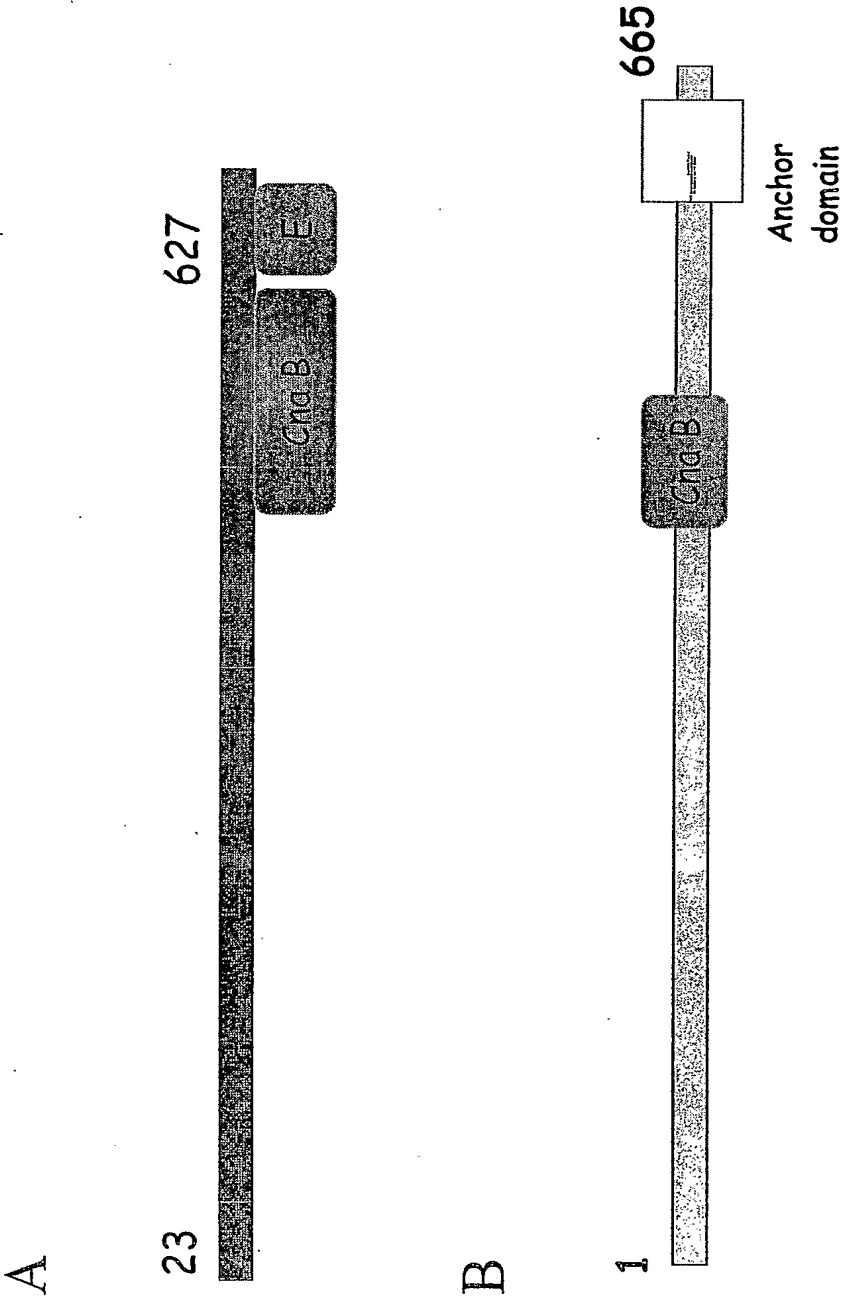

Figure 154

PCT/US05/27239 353/487

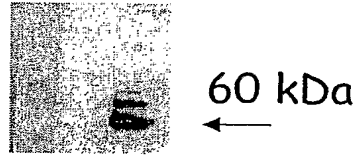

Figure 155

PCT/US05/27239

a T
r I
k G D
e R 3 R
r 4 9 6

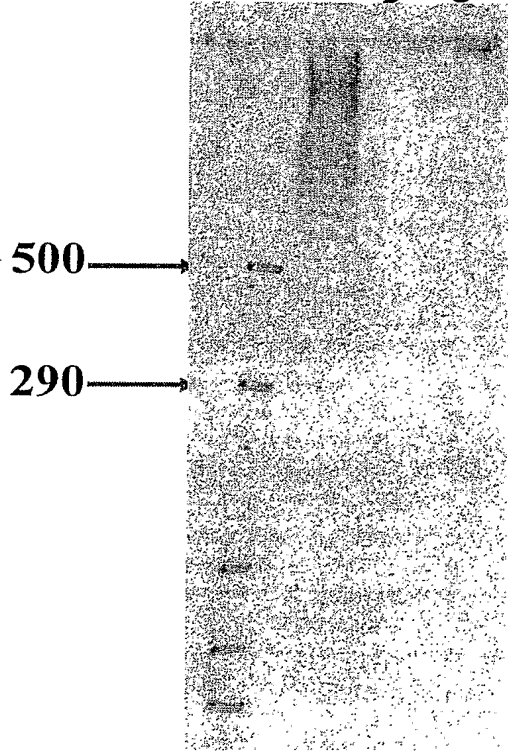

Figure 156

PCT/US05/27239

355/487

A

MISRIFFV~~MALCFSLV~~WGA*HAVAQOEDHTLVLQLENYQE~~VVSQ~~PSRDGHR~~LQV~~WK~~LDD~~SYS
 YDDR~~VQIV~~RDLHSW~~DENKLS~~FFKKT~~SFEMT~~FLENQIEVSHIP~~NGLY~~VRSIIQ~~TD~~AVSYP~~AE~~FLF
 EMTDQ~~TV~~EPLVIVAKK~~TD~~MTTKV~~KLK~~V~~DQ~~DHN~~R~~LEGV~~G~~FKLV~~S~~VARDV~~S~~EKEV~~P~~LIGEY~~R~~YSSS
 GQVGR~~TL~~Y~~TD~~KN~~GE~~IF~~V~~TNLPLGN~~Y~~RFKE~~V~~EPLAGYA~~V~~TTLD~~TD~~V~~Q~~LVD~~H~~QLV~~T~~IT~~V~~V~~N~~Q~~K~~L~~P~~RGN
 VDFMK~~V~~DGR~~T~~NTSLQ~~G~~AM~~F~~KVM~~K~~EE~~S~~GHY~~T~~PV~~L~~Q~~N~~G~~K~~EV~~V~~VT~~S~~G~~K~~D~~G~~R~~F~~R~~V~~E~~G~~L~~E~~Y~~G~~T~~T~~Y~~L~~W~~E~~L~~Q~~
 APTGYV~~Q~~L~~T~~SPV~~S~~FTIG~~K~~D~~T~~R~~K~~E~~L~~V~~T~~V~~V~~K~~N~~N~~K~~R~~P~~R~~D~~V~~P~~D~~T~~GE~~E~~T~~L~~Y~~L~~M~~L~~V~~A~~I~~L~~L~~F~~G~~S~~G~~Y~~Y~~L~~T~~K~~K~~P~~
 NN

B

5' cggaacc-cat-gtc-caa-gcg-caa-gaa 21mer, 61% G+C, Tm 60.8
 BamHI
 5' ccgctcgag-ctt-gtt-att-ttt-aac-cac 27mer, 44% G+C, Tm 58.4
 XhoI

Figure 157

A

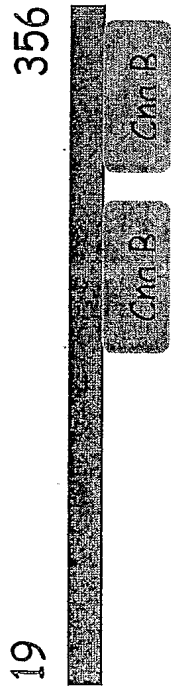

B



Figure 158

PCT/US05/27239 357/487

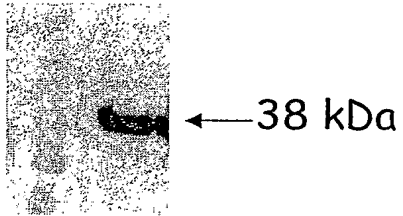

Figure 159

358/487

rr rr rr
g g g
M *A B C*

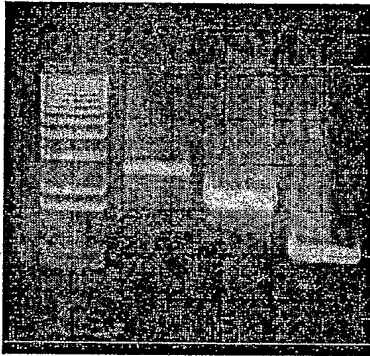
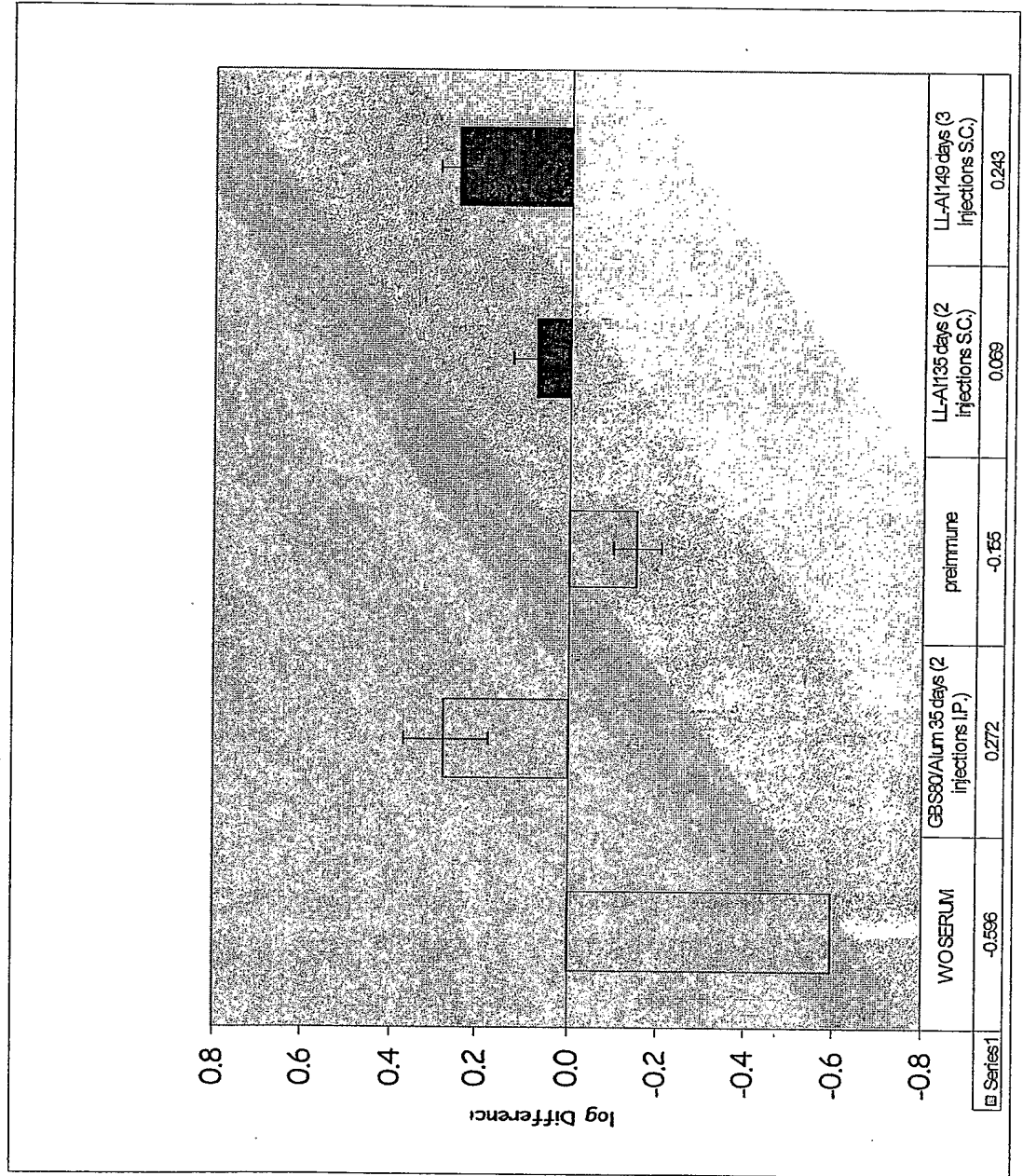

Figure 160

Figure 161



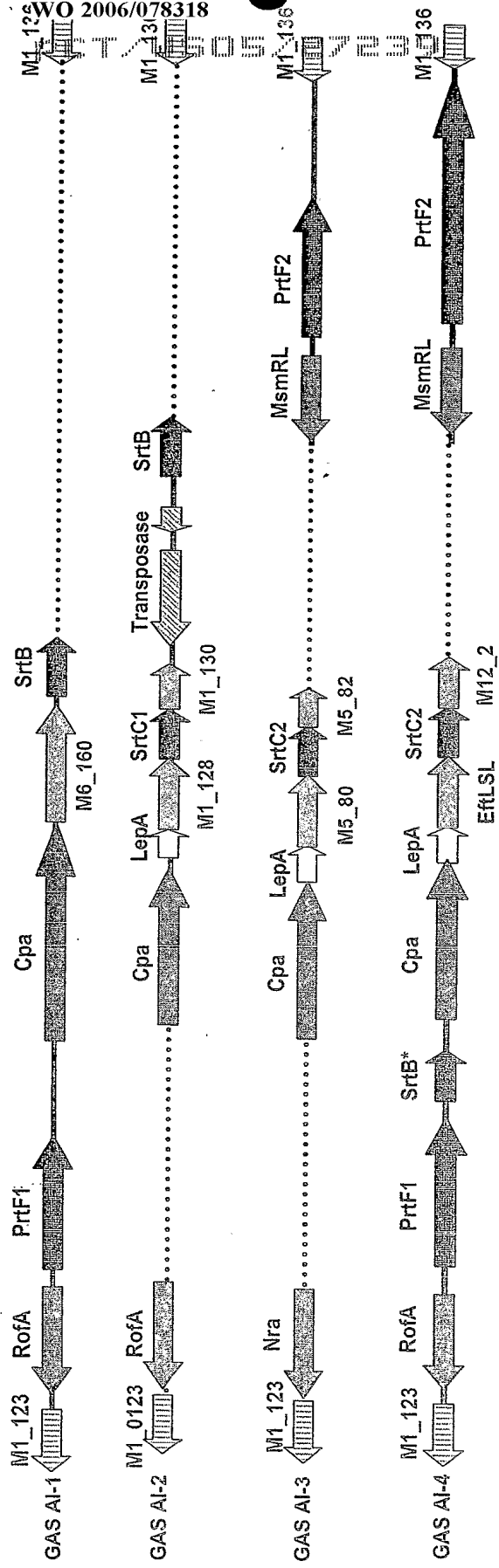
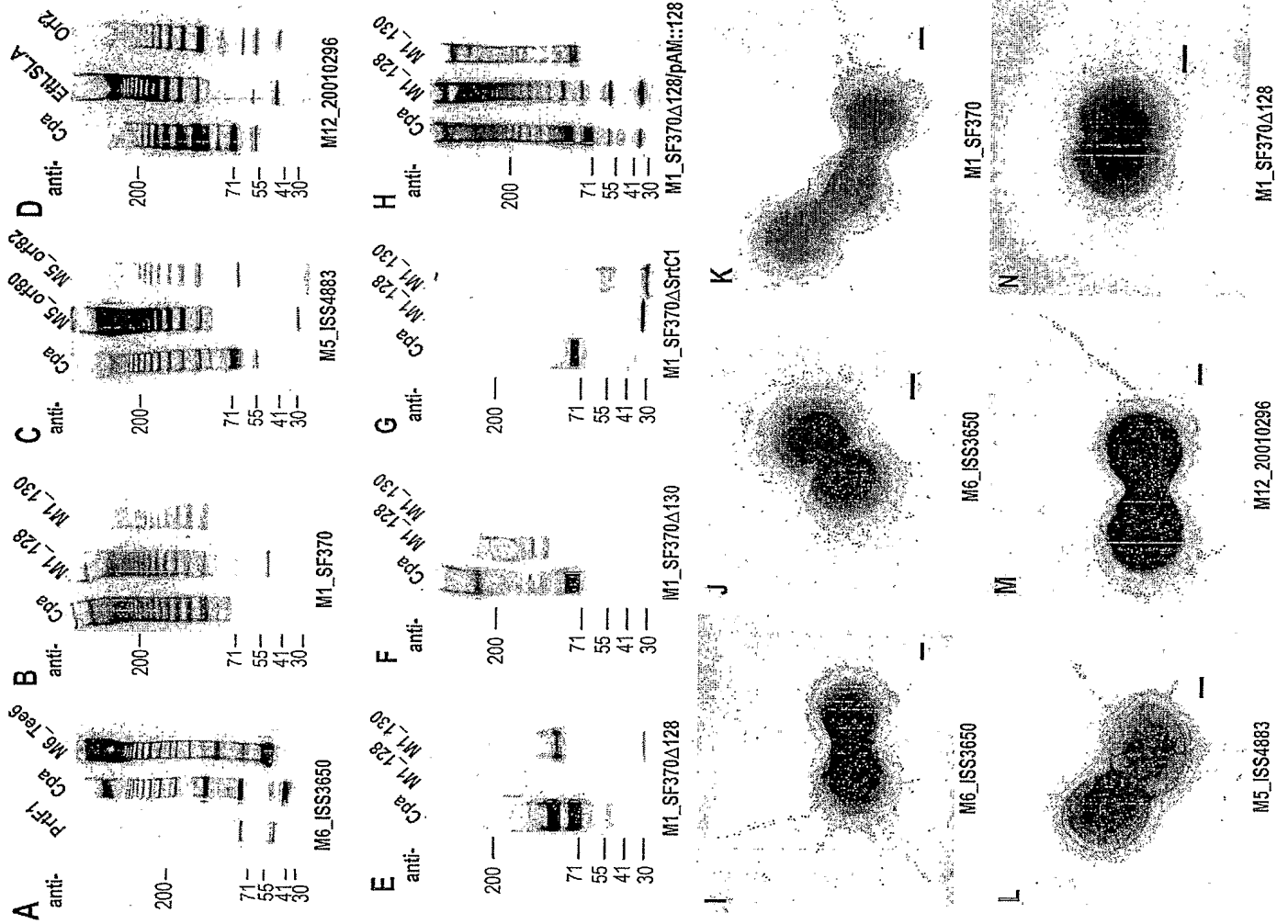

FIGURE 162

Figure 163



PCT/US05/27239 362/487

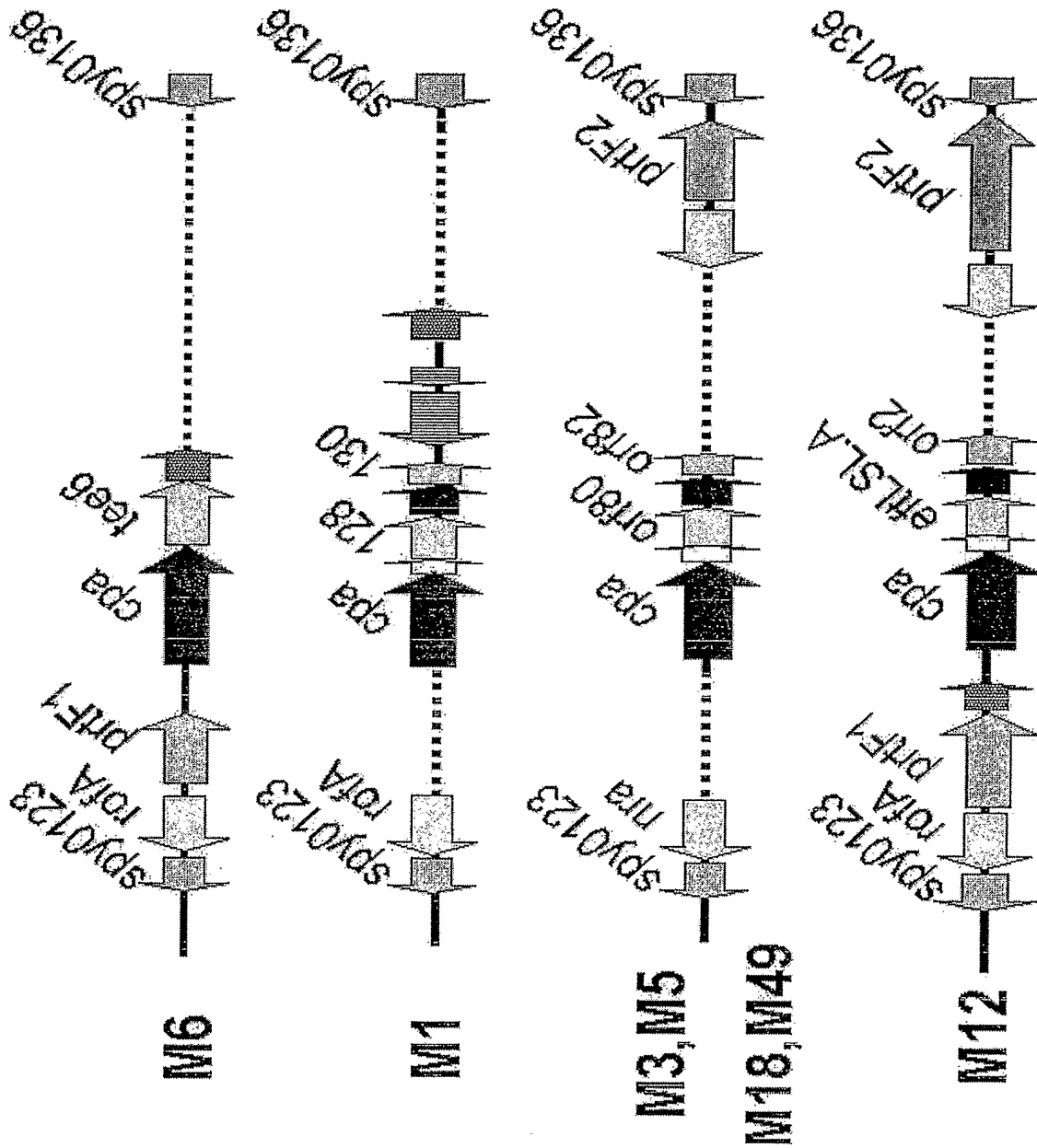

Figure 164

PCT/US05/27239363/487

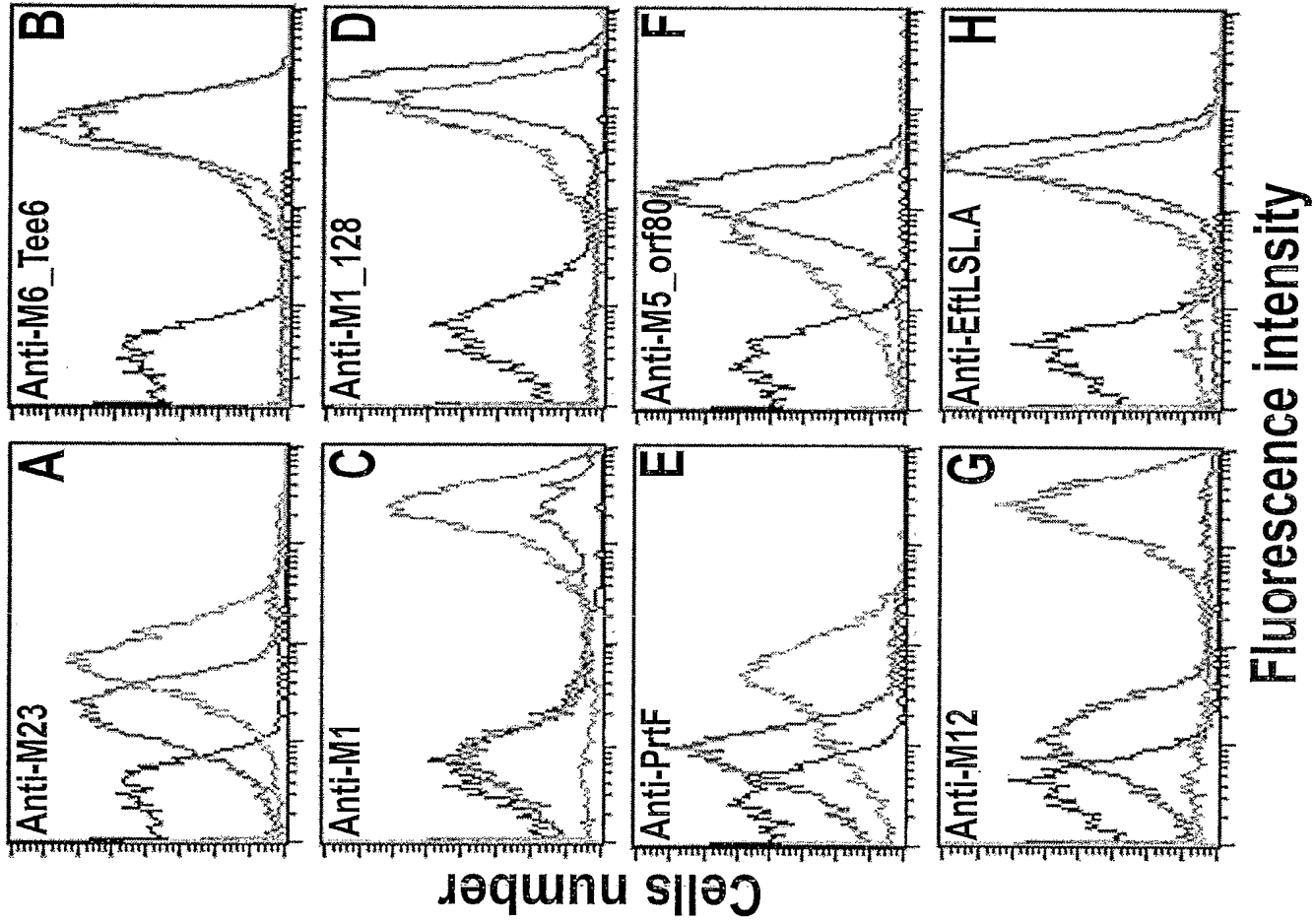

Figure 165

364/487

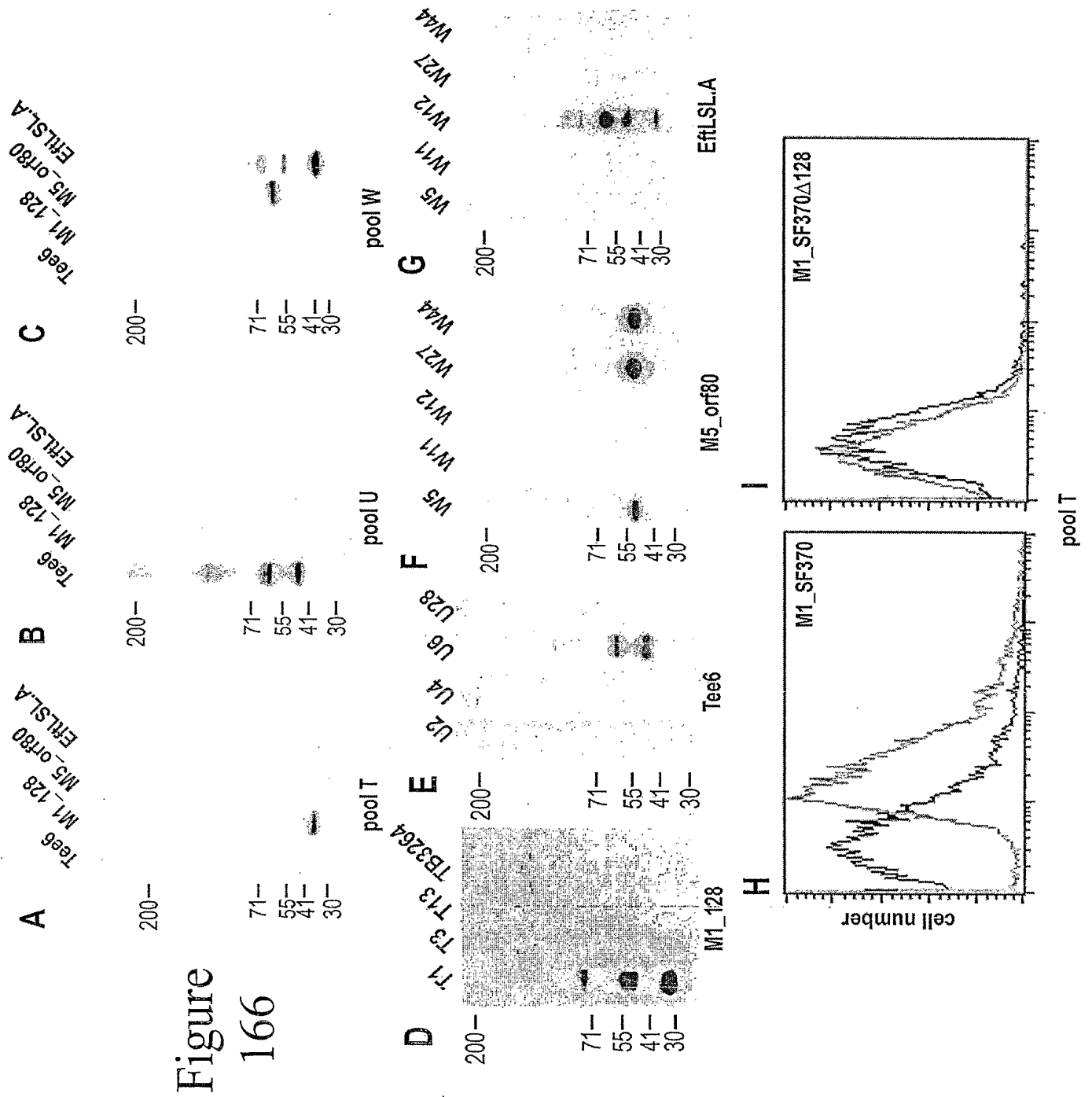

Figure 166

Figure 167

Strain	M-type	PCR					AI	Sequence
		SrtB	SrtC1	SrtC2	MsmRL	SipA2		
2724	6	+	-	-	-	-	1	
2894	6	+	-	-	-	-	1	
3650	6	+	-	-	-	-	1	
5529	6	+	-	-	-	-	1	
Dsm2071	23	+	-	-	-	-	1	+
SF370	1	+	+	-	-	-	2	literature
2580	1	+	+	-	-	-	2	
2913	1	+	+	-	-	-	2	
3280	1	+	+	-	-	-	2	
3348	1	+	+	-	-	-	2	
2719	?	+	+	-	-	-	2	
2721	3	-	-	+	+	+	3	
3040	3	-	-	+	+	+	3	
3135	3	-	-	+	+	+	3	
3776	44 ?	-	-	+	+	+	3	+
4959	77	-	-	+	+	+	3	+
4088	Clinical isolate	-	-	+	+	+	3	
2728	12	+	-	+	+	+	4	
2720	9	+	-	+	+	+	4	+
2727	11	+	-	+	+	+	4	+
4436	28	+	-	+	+	+	4	+
5481	44 ?	+	-	+	+	+	4	+
4538	50	+	-	+	+	+	4	+
3789	78	+	-	+	+	+	4	+
4883	5	+	-	+	+	+	4	
5476	89	+	-	+	+	+	4	
5495	?	+	-	+	+	+	4	
2722	4	-	-	-	-	-	?	
2723	5?	-	-	-	-	-	?	
2725	8	-	-	+	-	-	?	
2726	2	-	-	-	-	-	?	
2634	4	-	-	-	-	-	?	
5531	75	+	+	-	-	-	?	In progress

Figure 168

Immuno-electronmicroscopy

(Immunogold Negative Staining,
1° α - 80, 2° α - mouse gold particles 10nm)

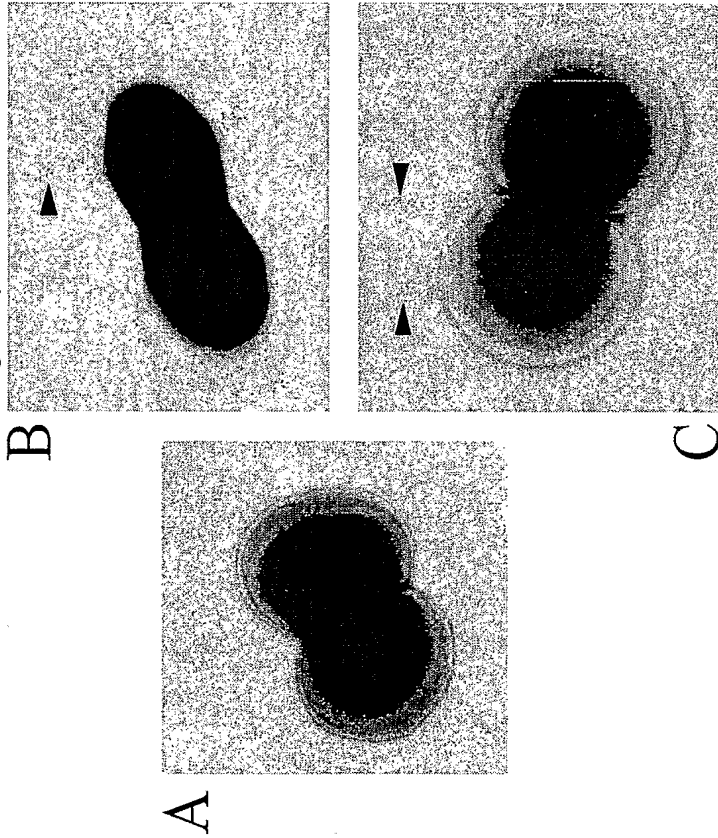

L.lactis -

L.lactis + AI-1 +

Figure 169

L. lactis

L. lactis + AI-1

L. lactis

L. lactis + AI-1

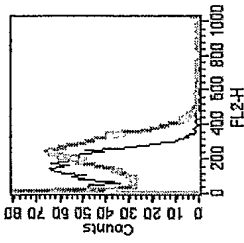

Δ Mean < 100

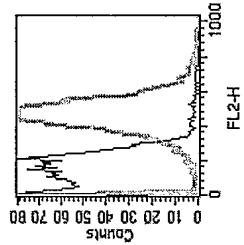

Δ Mean 298

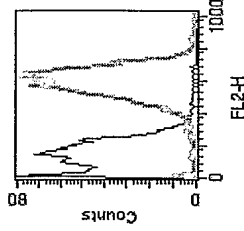

Δ Mean 461

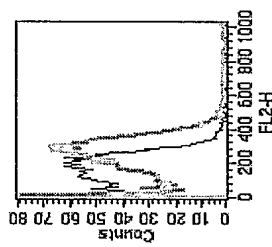

Δ Mean < 100

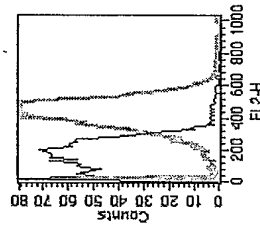

Δ Mean < 251

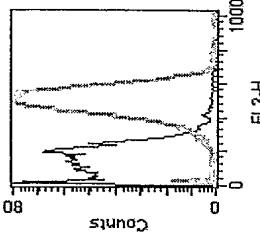

Δ Mean < 355

α -80

α -104

Figure 170

Phase contrast Microscopy Immuno-electronmicroscopy
 (Immunogold Negative Staining,
 1° α -80, 2° α -mouse gold particles 10nm)

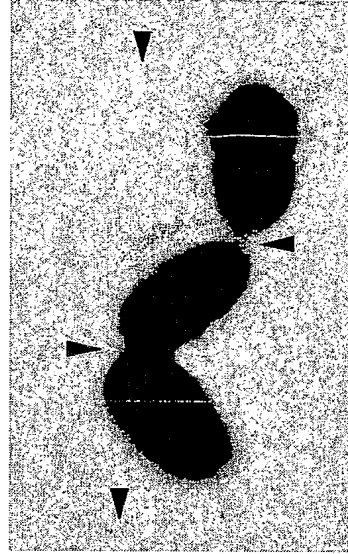
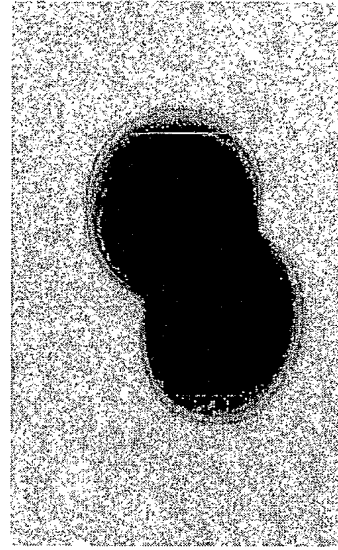

L. lactis

L. lactis + AI-1

Figure 171

Gel filtration on Sepharyl HR 400

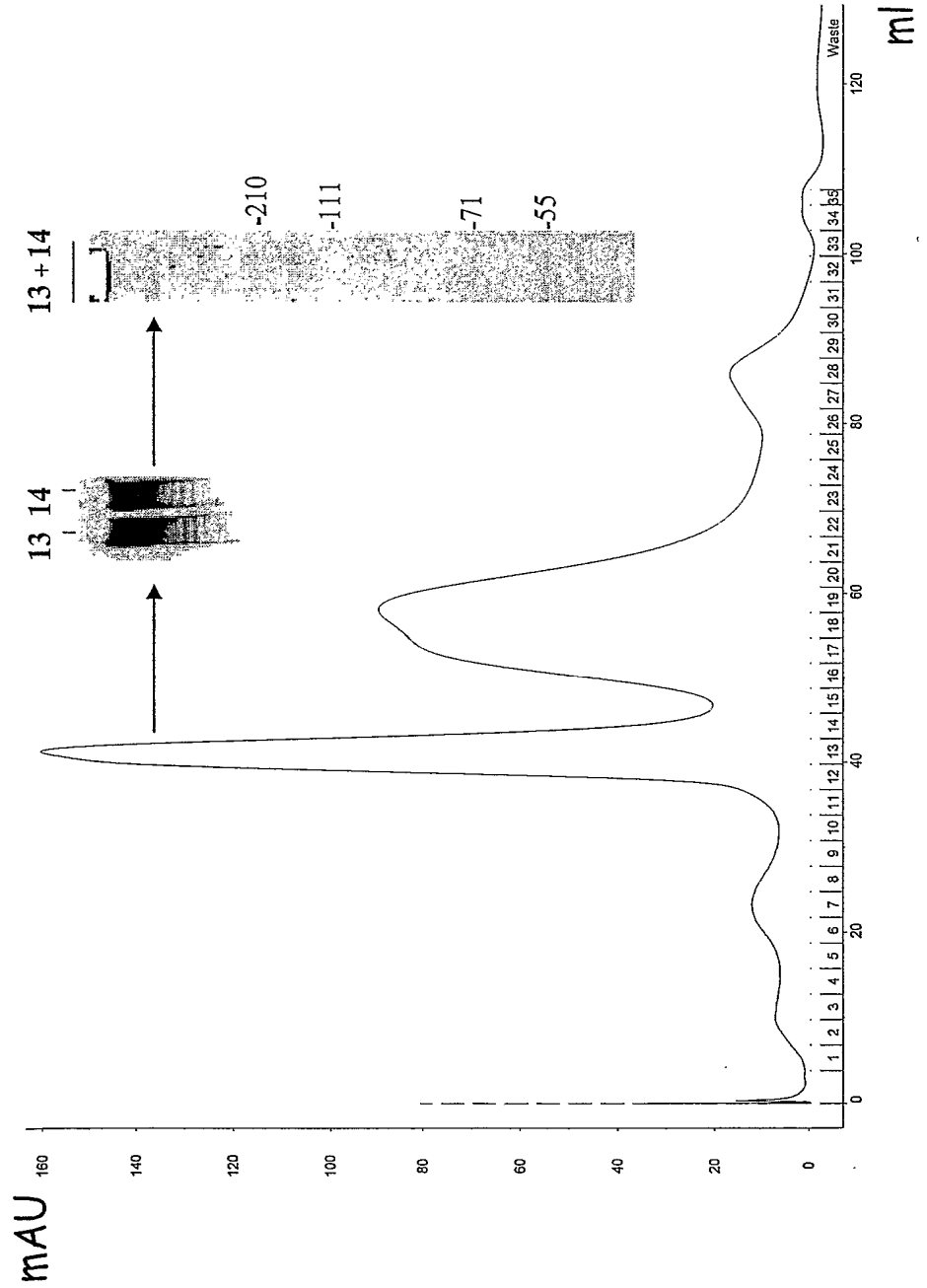

370/487

Figure 172

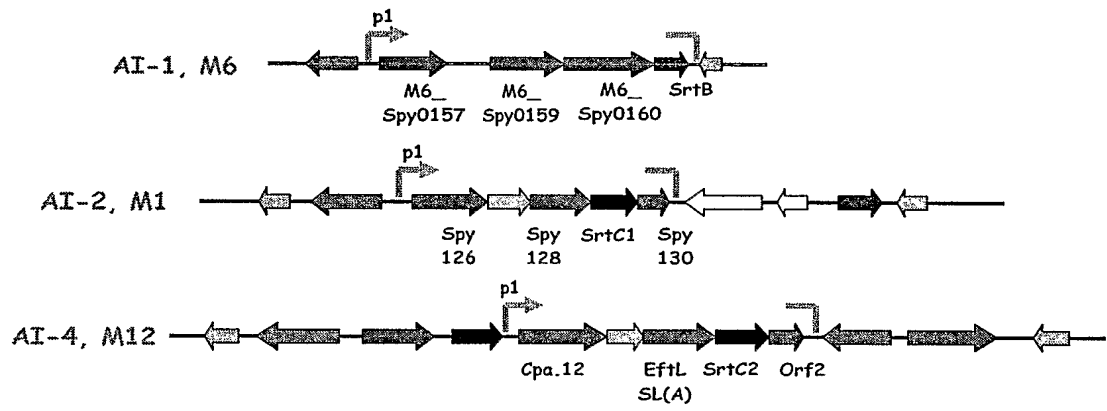

PCT/US05/27239 371/487

Figure 173

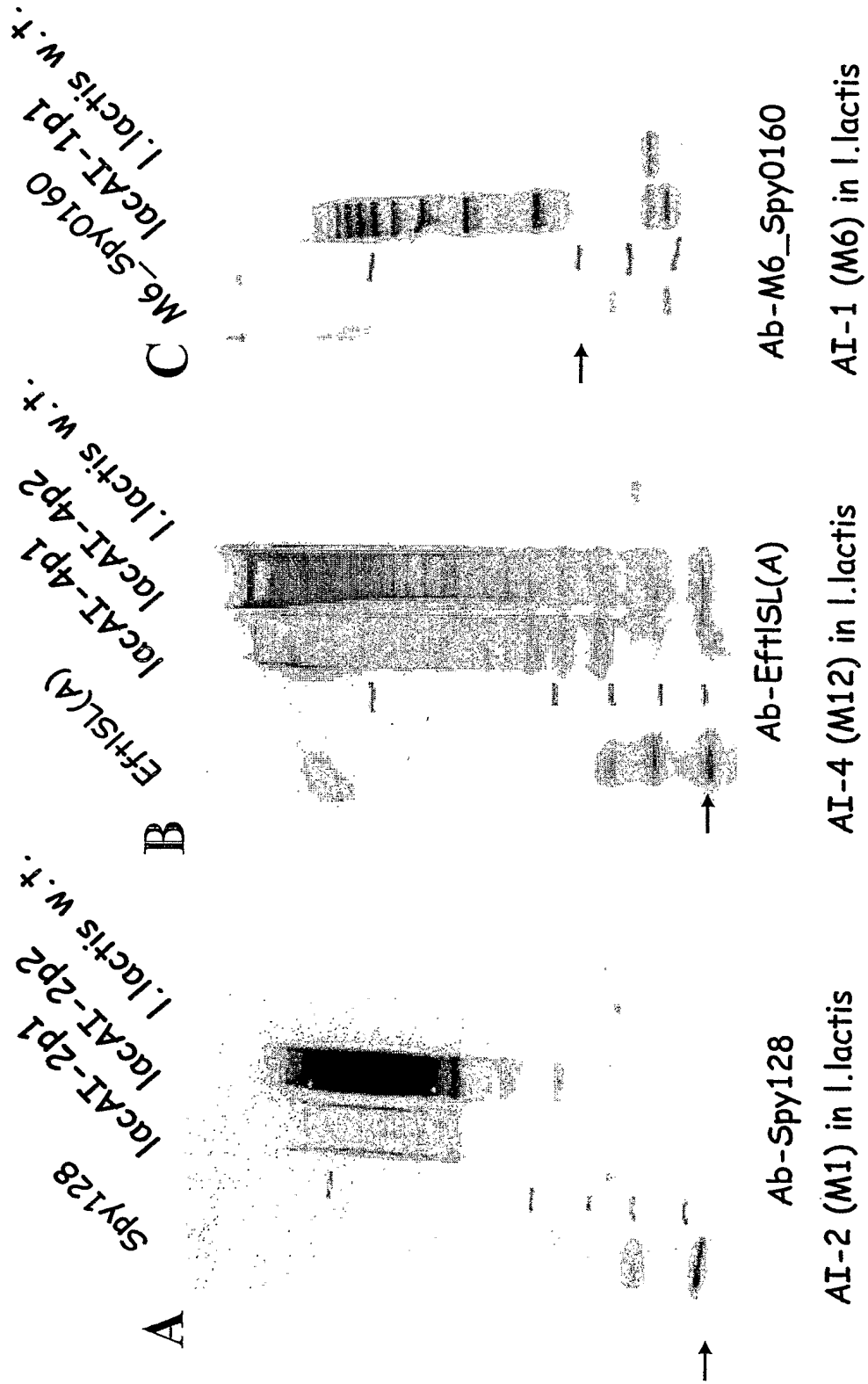

372/487

Figure 174

M6_Spy0157

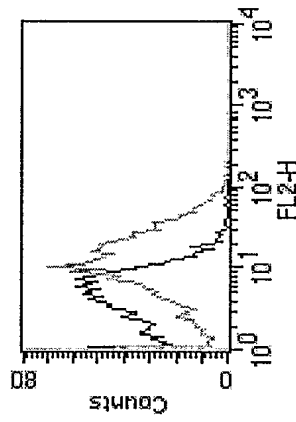

373/487

Figure 175

Orf2

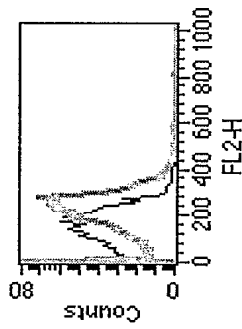
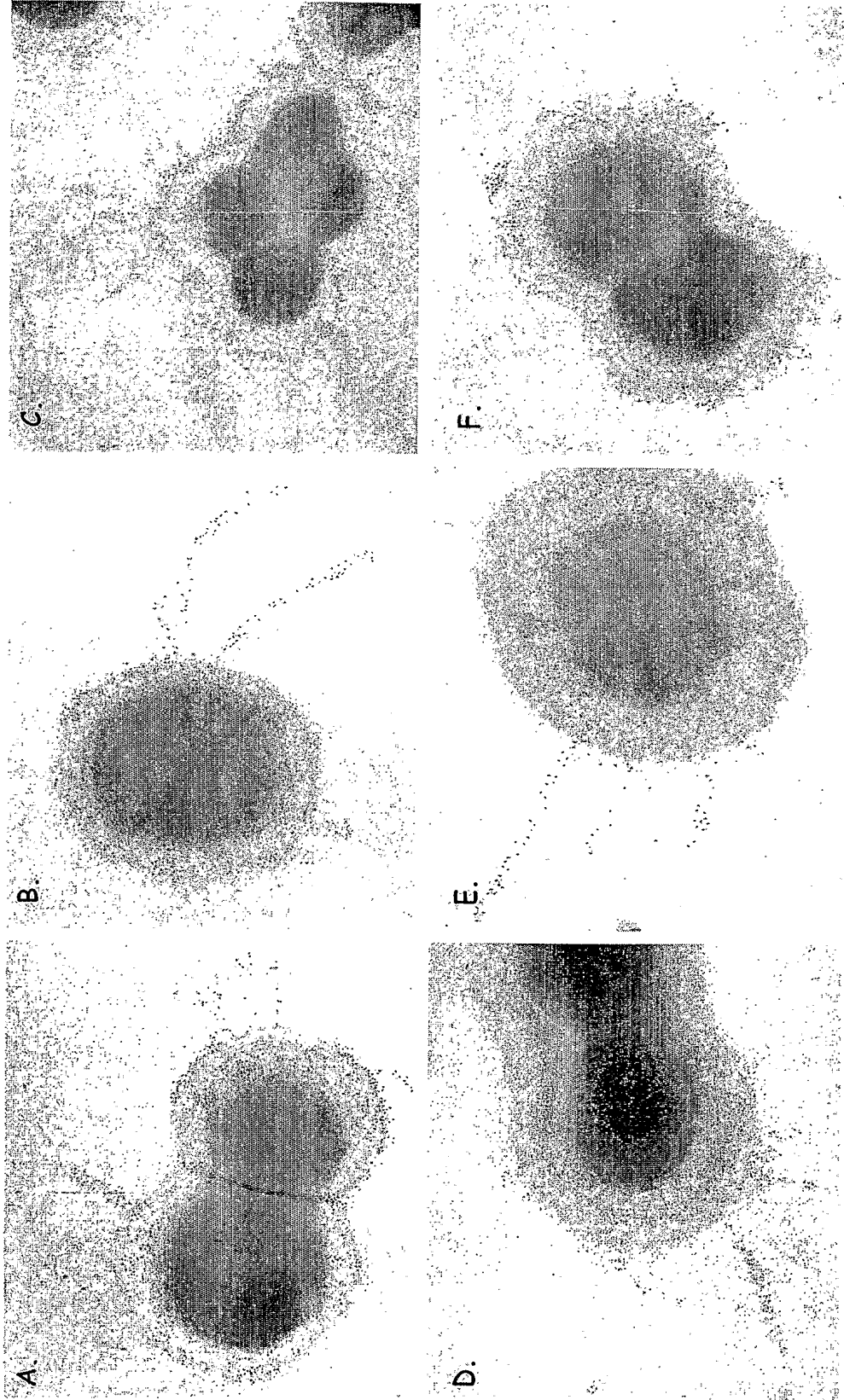

Figure 176



Immunogold labeling with antibodies against: A. B. C. D. E. M6_Spy0160; F. M6_Spy0159

375/487

Figure 177

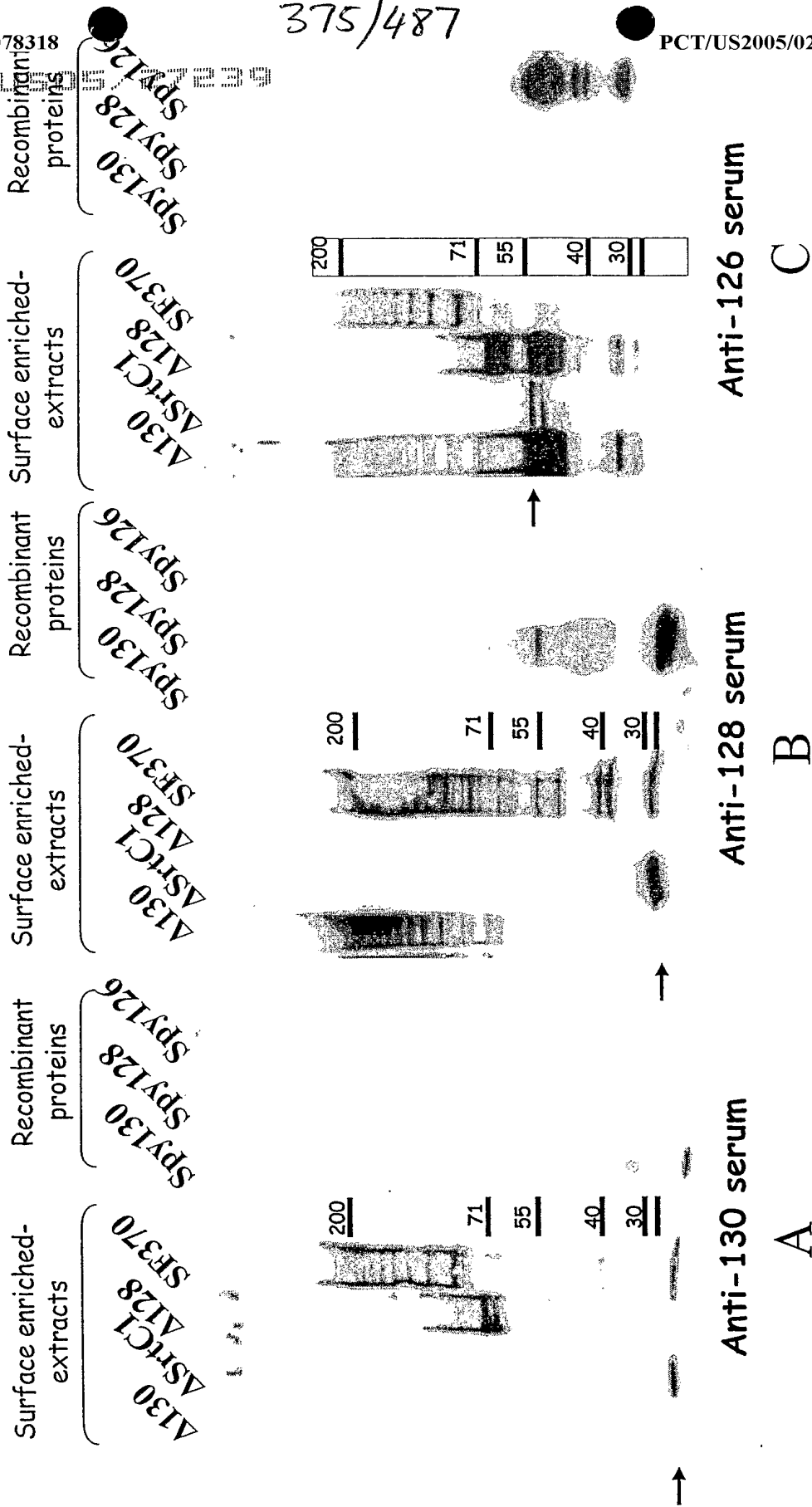
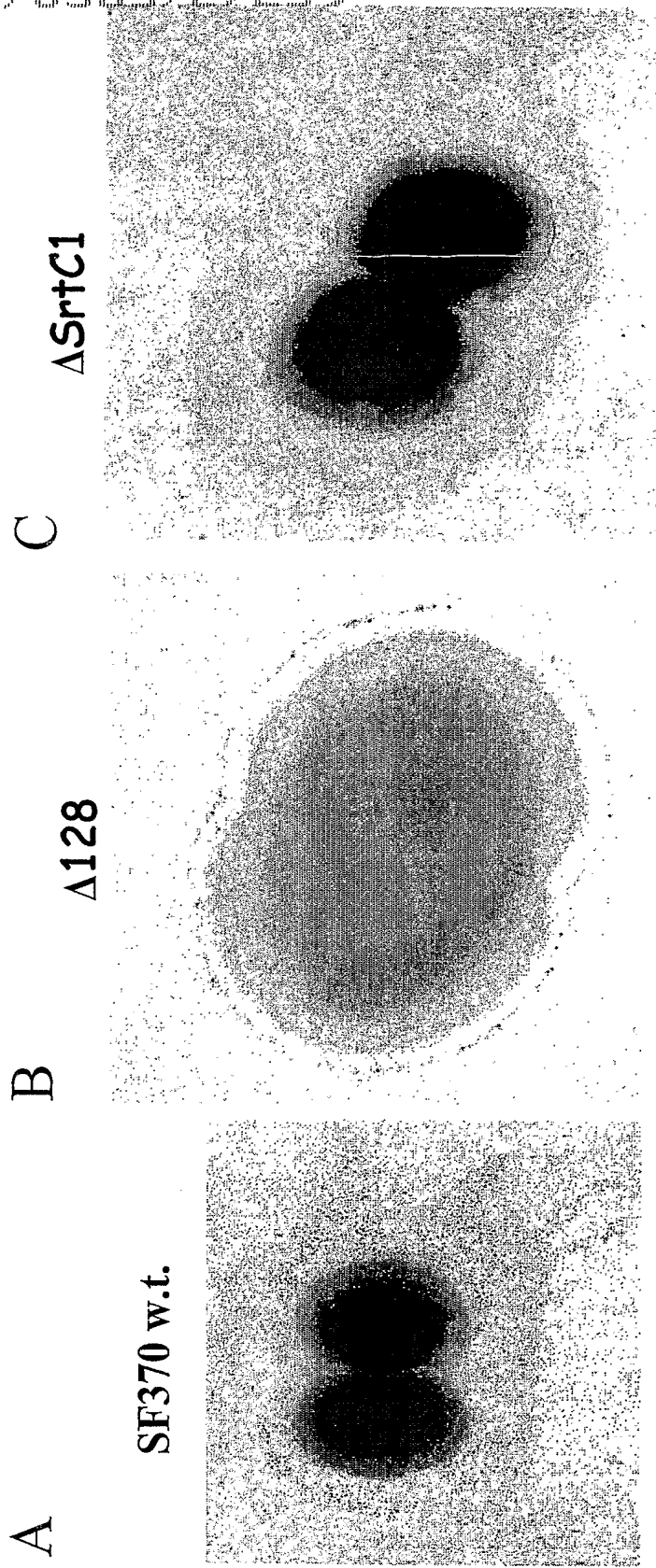

Figure 178



Immuno-gold labeling with sera against Spy128

Comparison of wild type and mutant strain by Immunoelectron Microscopy show that Spy128- or SrtC1-lacking bacteria are not able to assemble pili. SrtC1, therefore, is absolutely required for pilus assembly but not for surface anchoring.

Figure 179

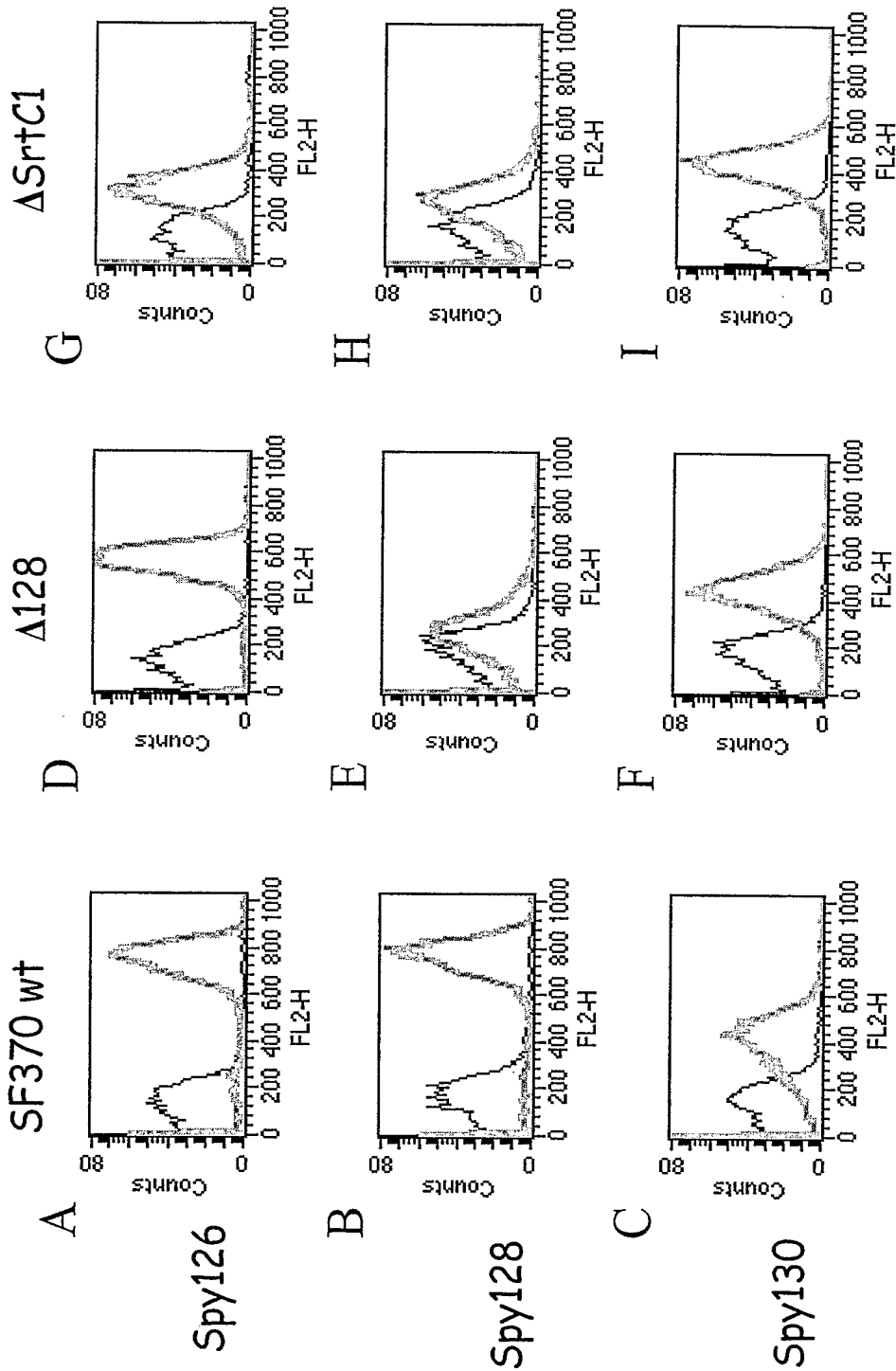
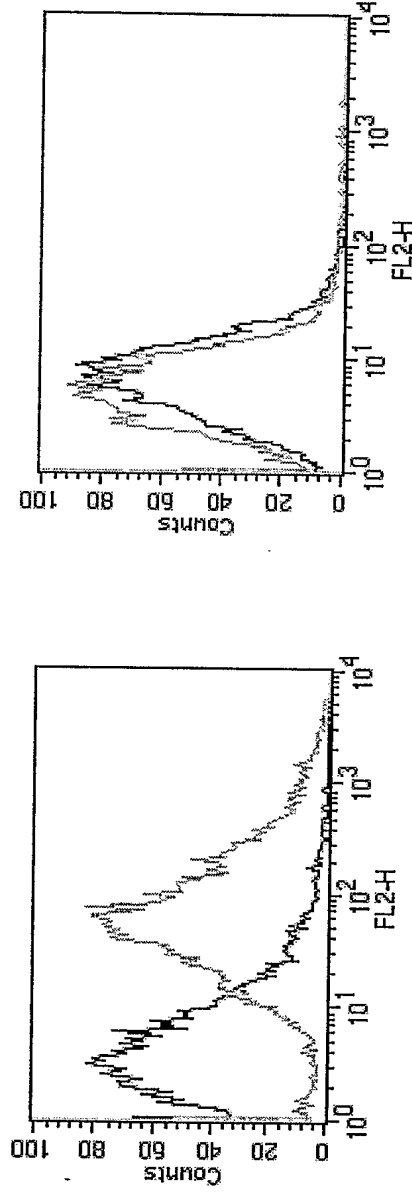

Figure 180

A SF370 B SF370_ΔLepA



Key
— Preimmune M1
— Immune M1

PCT/US05/27239 379/487

Figure 181

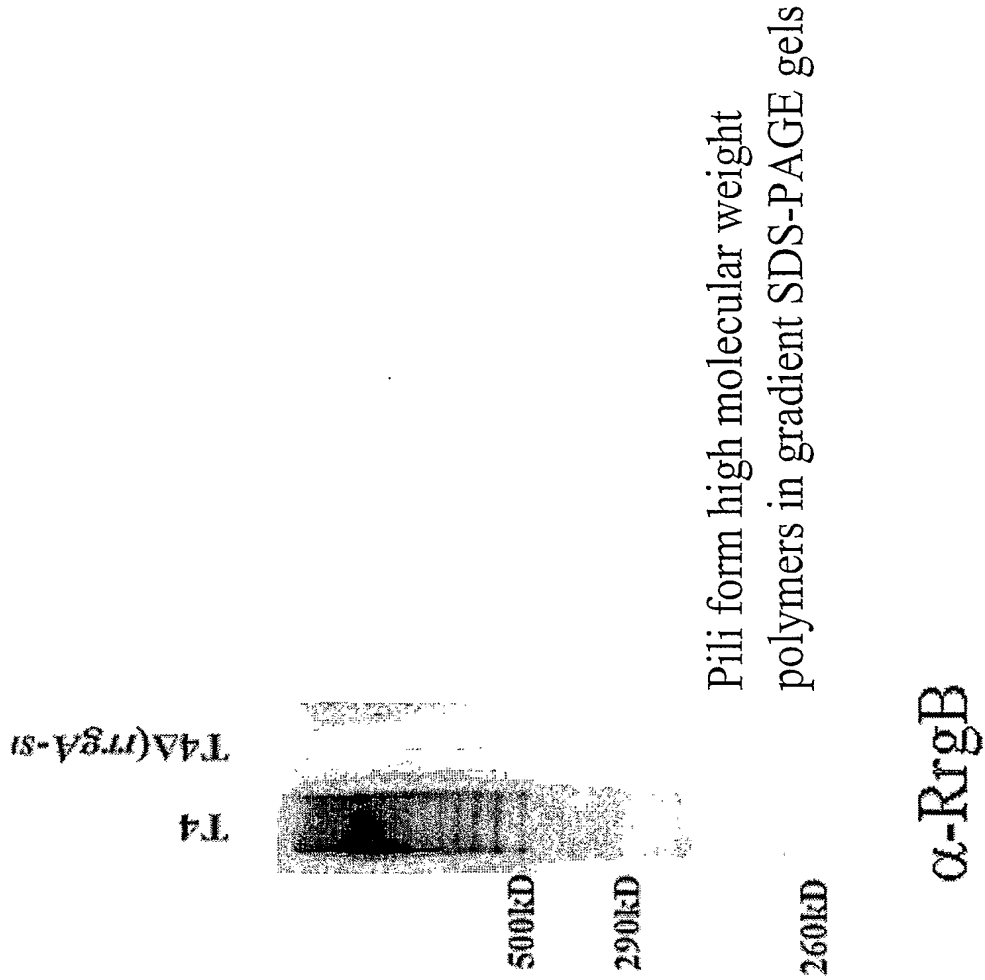
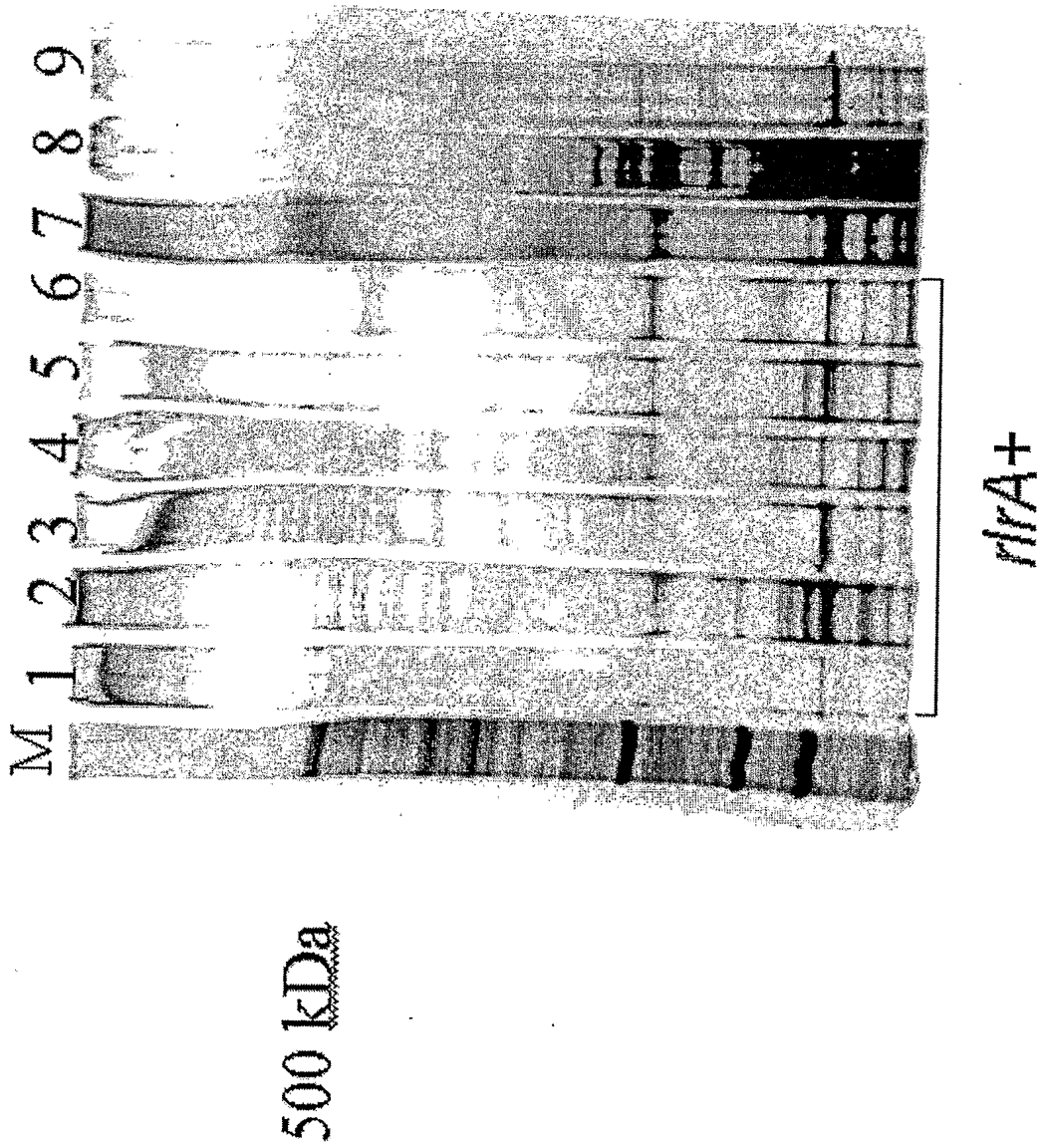

Figure 182



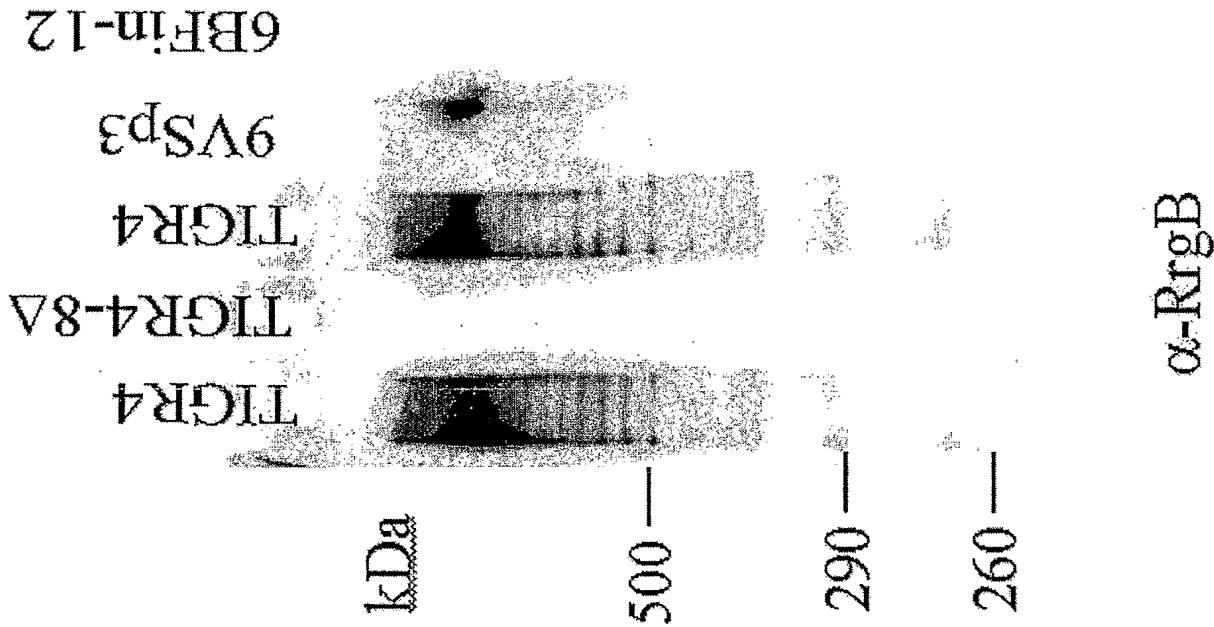
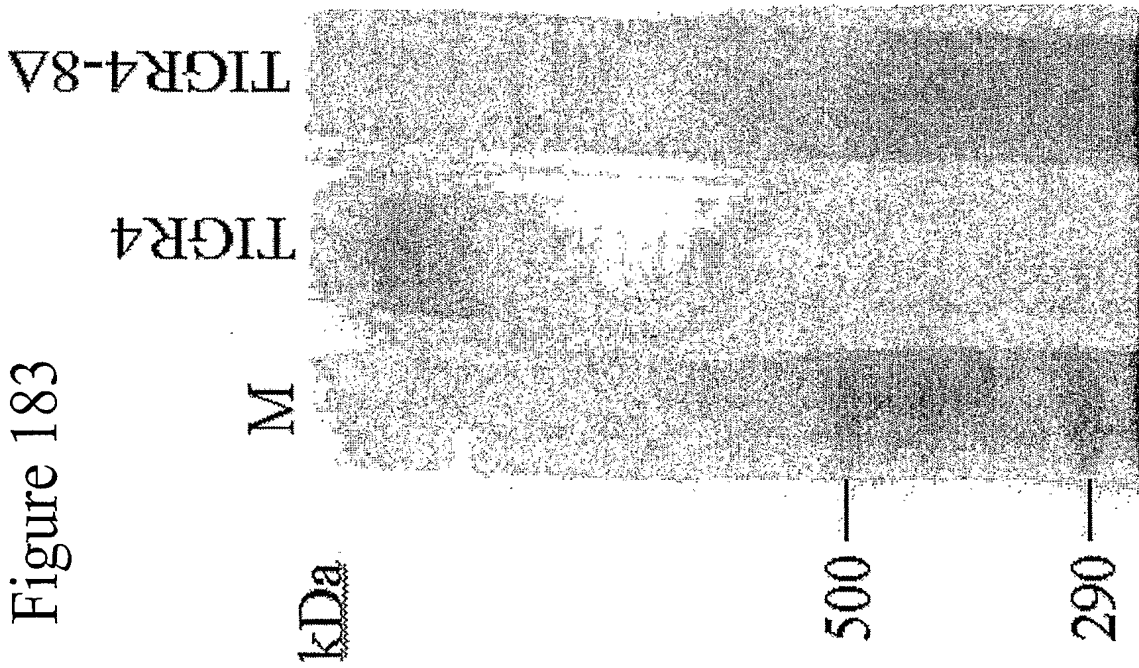

Figure 183



Silver stained gel 3-8%

Anti-RrgB TIGR4 recognized the 9v pili

382/487

Figure 184

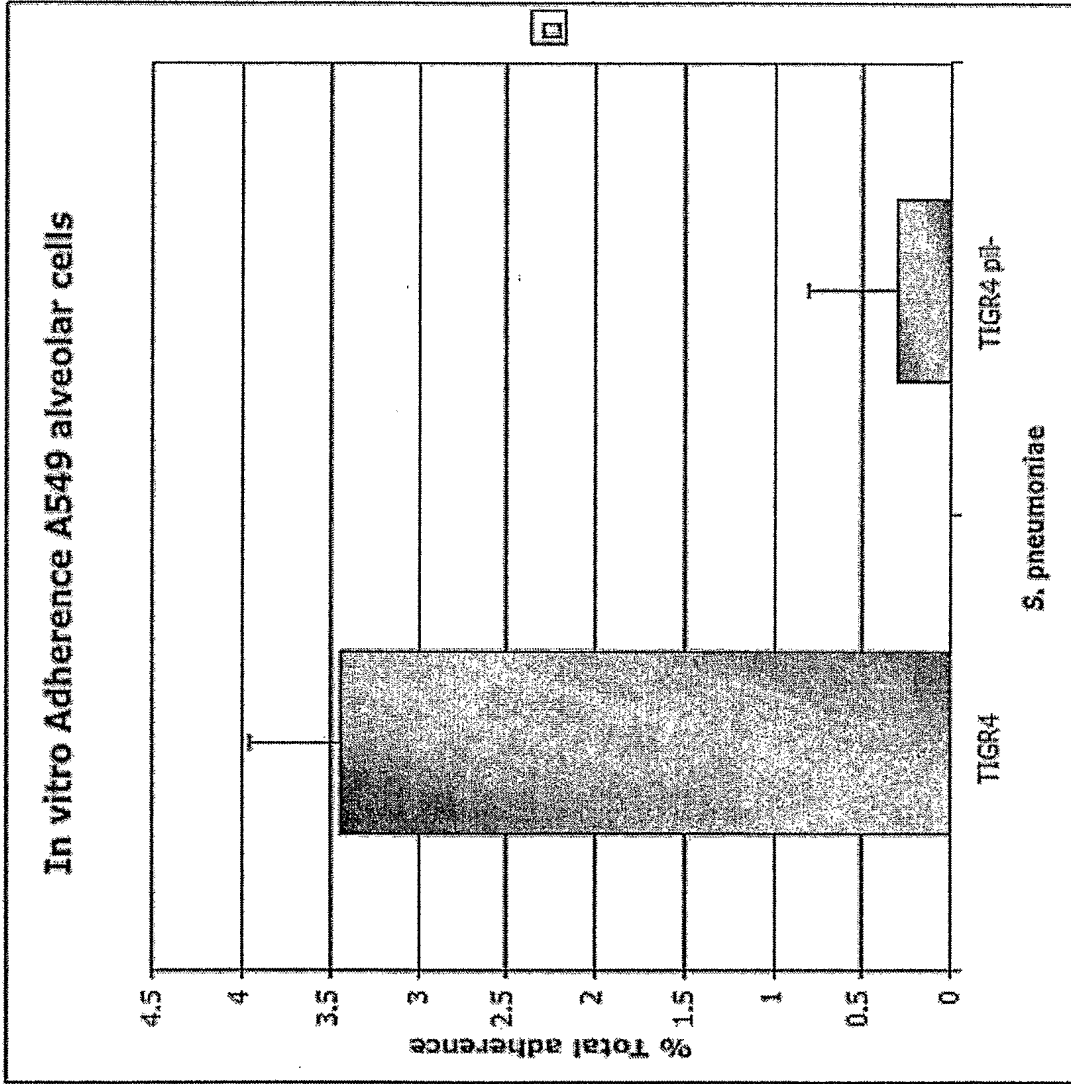

PCT/US05/27239 383/487

Figure 185

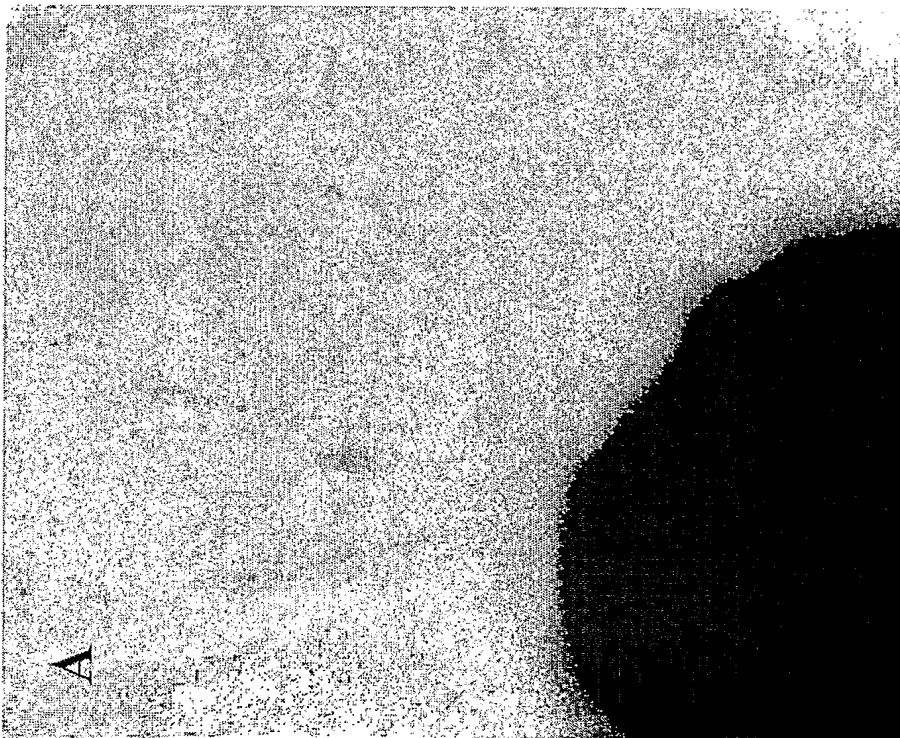

384/487

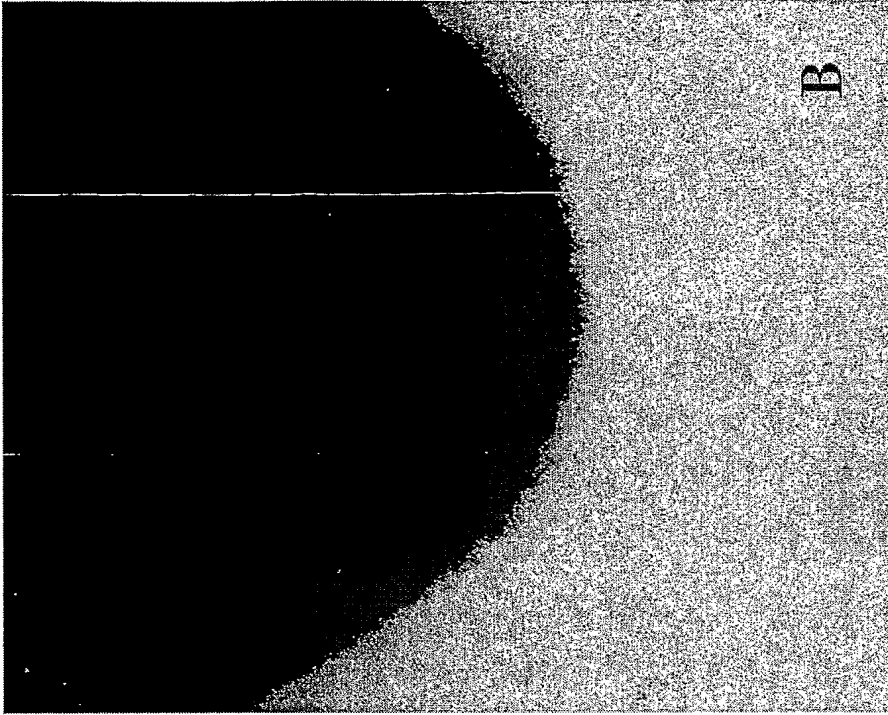

Figure 186

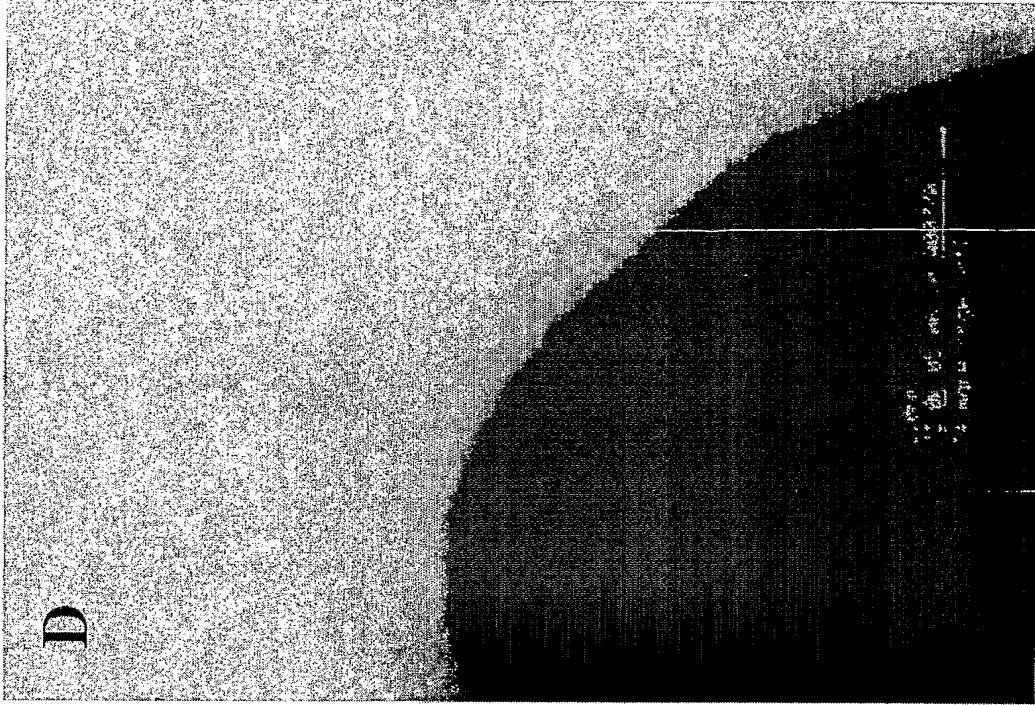

Figure 188

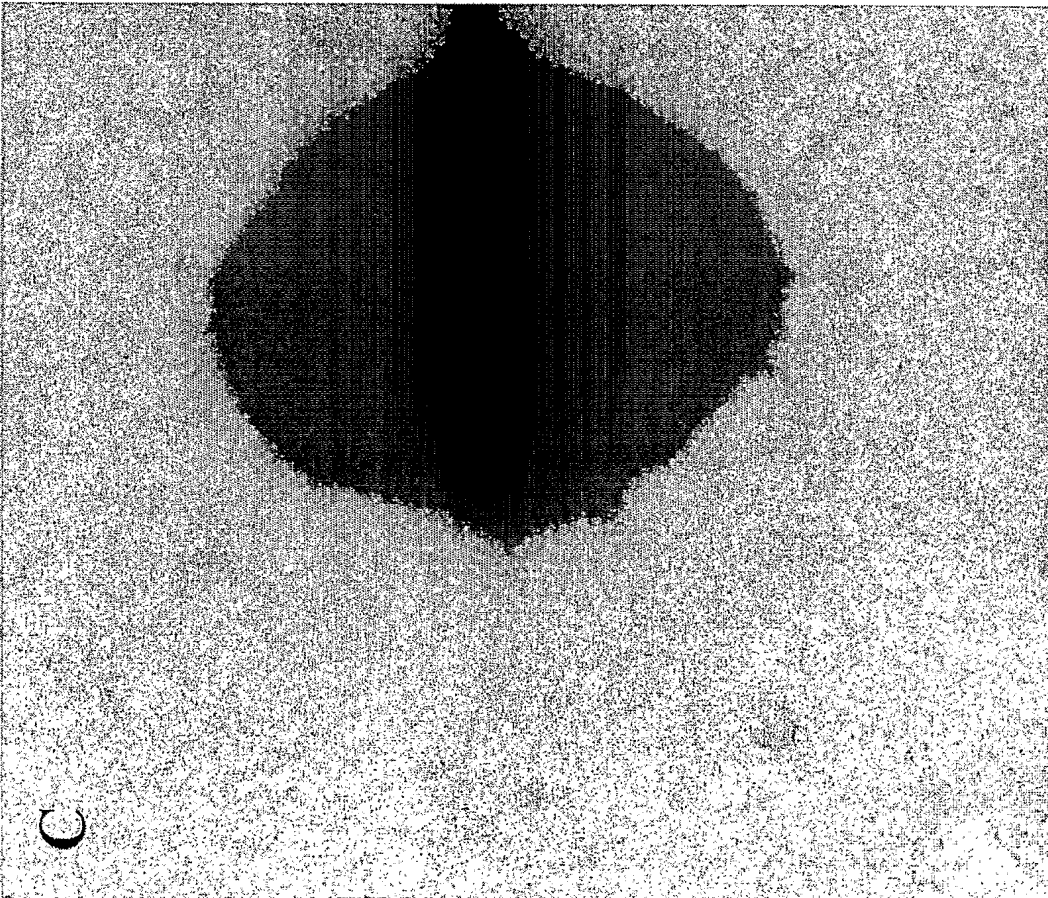

Figure 187

Figure 189

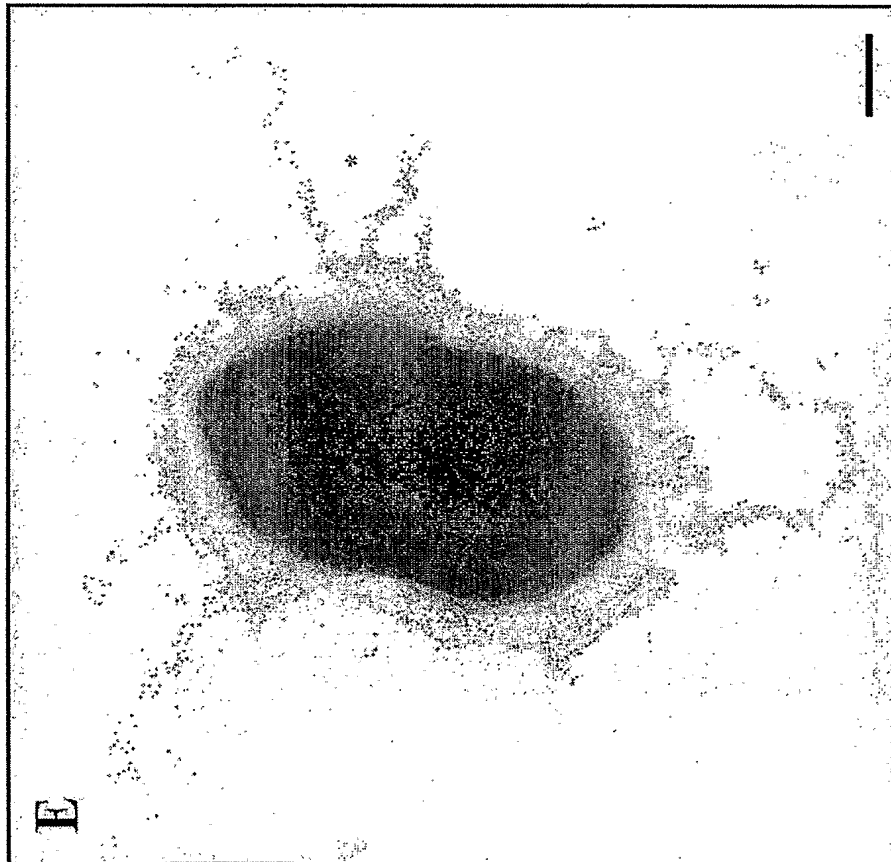

Figure 190

S. pneumoniae pili proteins: sp0462 (Rrg.A)

Expression and purification:

- pET 21b+-*rrg.A-6*
- purified in soluble form (stored at -80°C; in NaCl_{physiol.})



Results:

- protein conc.: 1,1 mg/ml

A

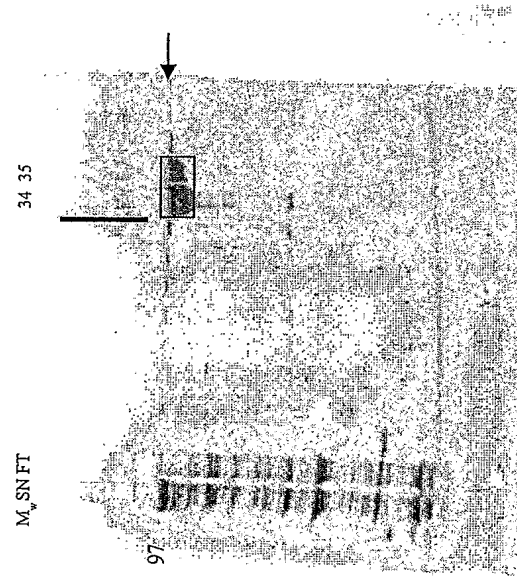

SDS-page

B

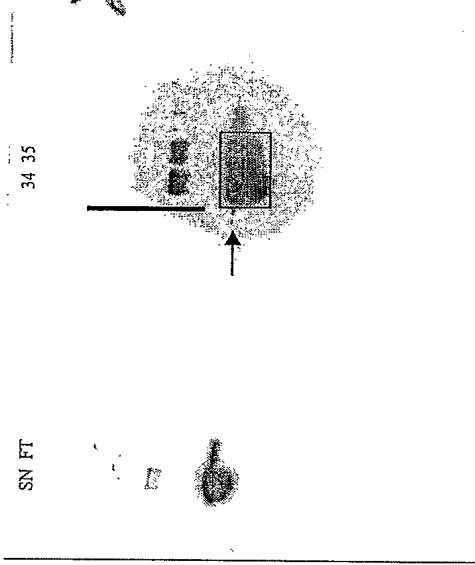

Western blot (anti-HIS)

S. pneumoniae pili proteins – antibody production (mice)

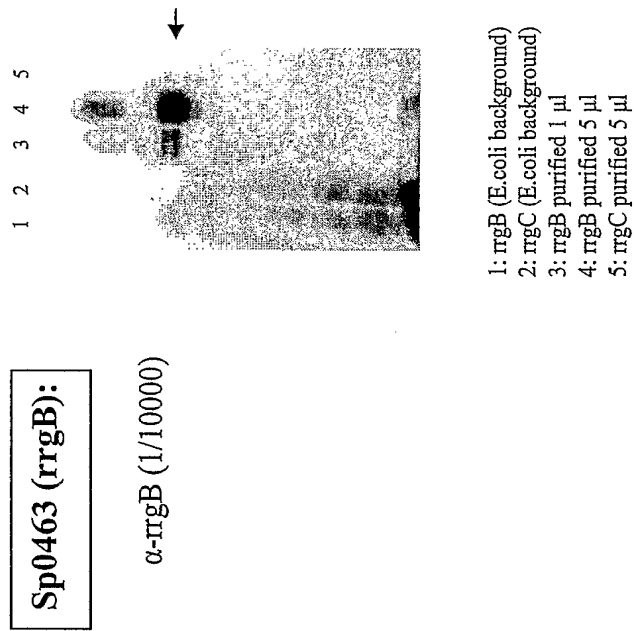

Figure 191

S. pneumoniae pili proteins – antibody production (mice)

PCT/US05/27239 389/487

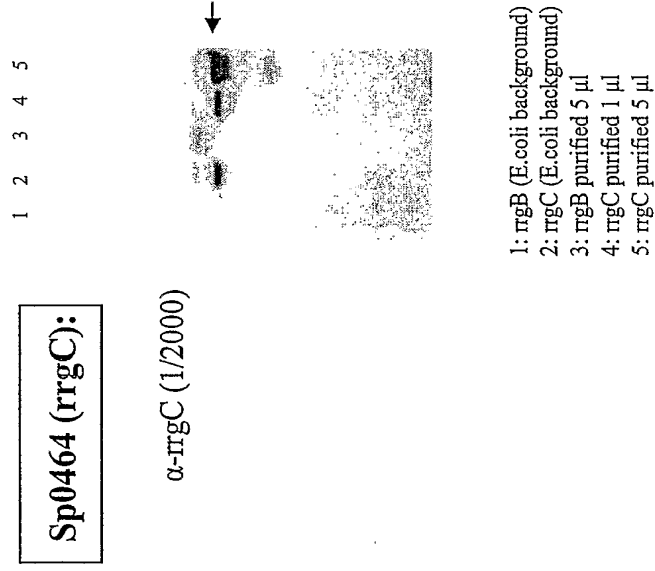
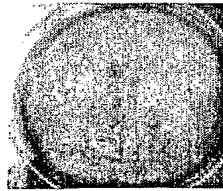

Figure 192

S. pneumoniae TIGR4 plus purification I – cultivation + digestion



S. pneumoniae TIGR4
Blood plates
ON/37°C/13h

- Resuspension in PBS/washing
- Resuspension in PPB (4-6 plates/ml)
(20% sucrose, 10mM MgCl₂,
50mM NaPPi pH6.3)

- Digestion with Mutanolysin
(N-Acetyl Muramidase)
37°C, ~10 h

Pellet
SN
Sucrose Density
gradient centrifugation

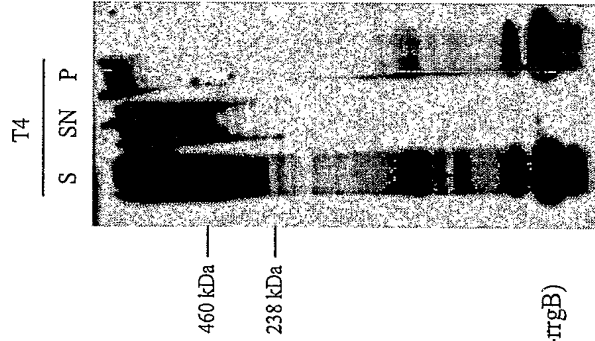
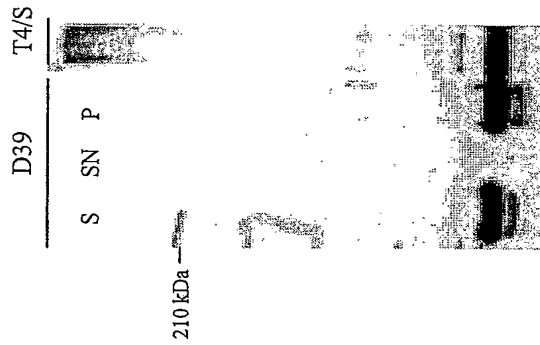

Western (1.AK. α-irgB)

Figure 193

S. pneumoniae TIGR4 plus purification II - Sucrose density gradient centrifugation

PCT/US2005/027239

950µl SN
25-56% linear sucrose gradient
SW40; 38000, 4°C, 16h



24 x 500 µl fractions
(Gradient master)



Gel filtration

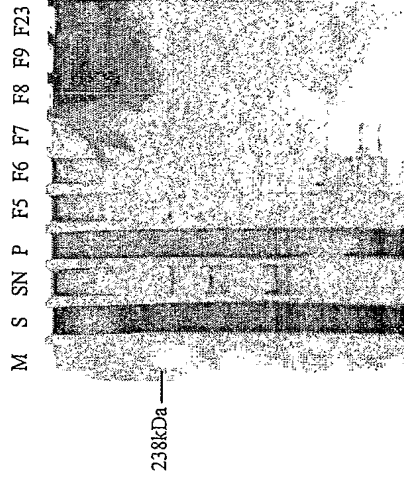
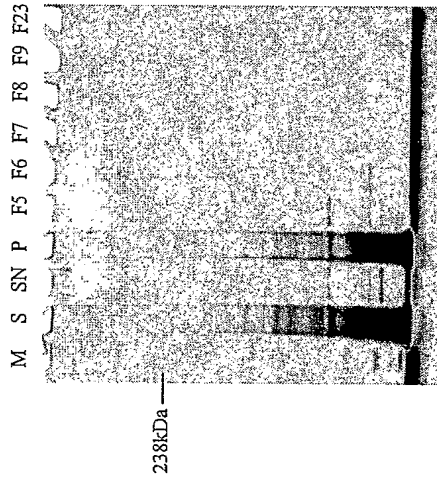
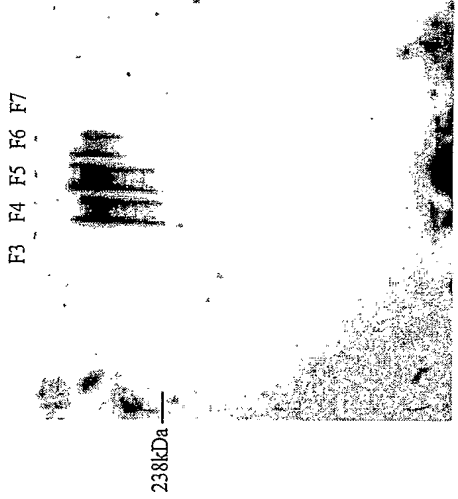
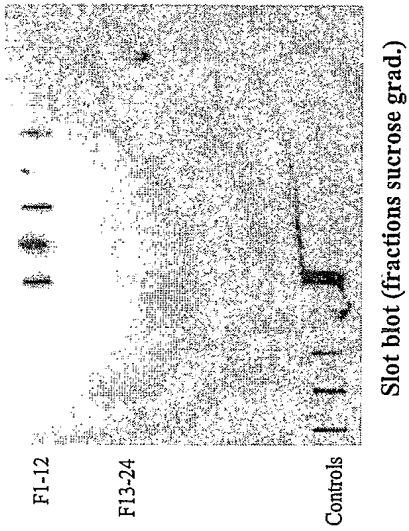
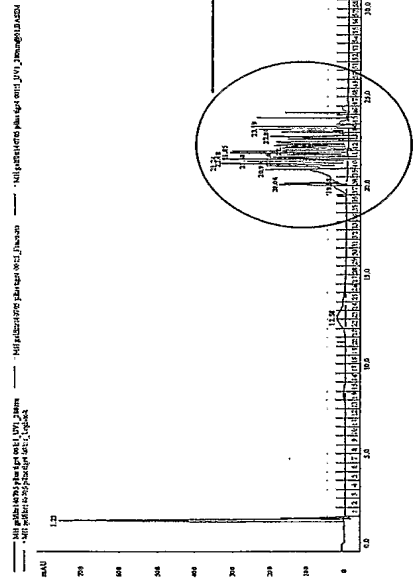

Figure 194

S. pneumoniae TIGR4 pilus purification III – Gel filtration

PCT/US2005/027239



400 µl Fr.5
Superdex 200

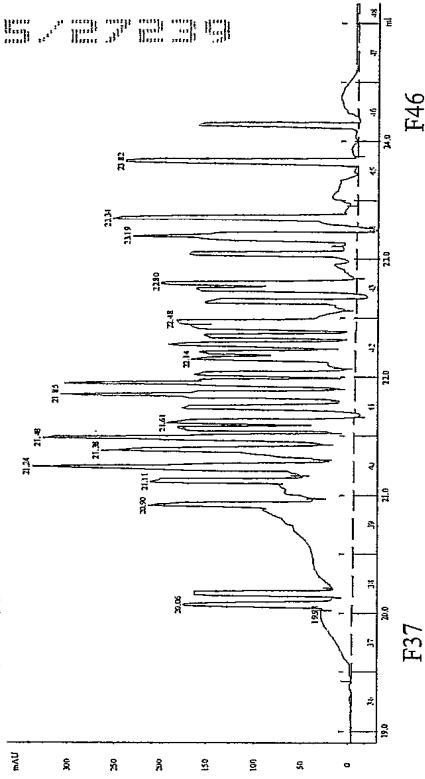

F37

F46

M L 37 38 39 40 41 42 43 44 45 46

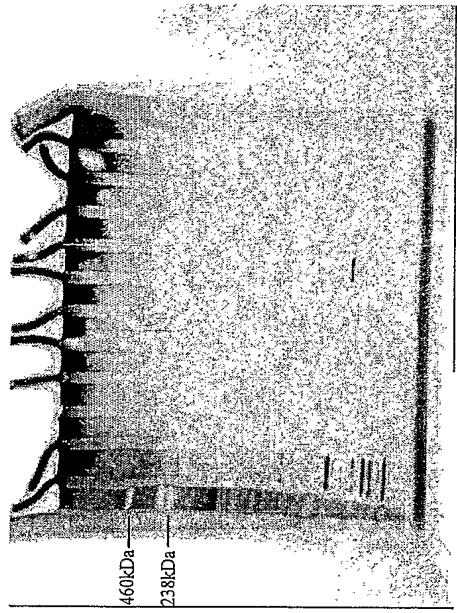

Figure 195

PCT/US05/27239

14CSR -----GTTTAGGCGCTTTTCATTATAAGTCTTATGGGACTTTTTTGATACTCAAAAAGC
670 TGAGTTGTTTAGGCGCTTTTCATTATAAGTCTTATGGGACTTTTTTGATACTCAAAAAGC
6BF -----GTTTAGGCGCTTTTCATTATAAGTCTTATGGGACTTTTTTGATACTCAAAAAGC
6BSP -----GCGCTTTTCATTATAAGTCTTATGGGACTTTTTTGATACTCAAAAAGC
19AH -----GTTTAGGCGCTTTTCATTATAAGTCTTATGGGACTTTTTTGATACTCAAAAAGC
23FPO -----TTTAGGCGCTTTTCATTATAAGTCTTATGGGACTTTTTTGATACTCAAAAAGC
19FTW -----TTTTTCATTATAAATCTTATGGGACTTTTTTGATACTCAAAAAGC
9VSP -----TTTAGGCGCTTTTCATTATAAGTCTTATGGGACTTTTTTGATACTCAAAAAGC
TIGR4 -----TTTAGGCGCTTTTCATTATAAGTCTTATGGGACTTTTTTGATACTCAAAAAGC
23FTW -----GCGCTTTTCATTATAAGTCTTATGGGACTTTTTTGATACTCAAAAAGC

14CSR CCTATAATCTCCACAGTGGGATTTACCCACTACAGAAATTATAGAGCCAGAAAAACACT
670 CCTATAATCTCCACAGTGGGATTTACCCACTACAGAAATTATAGAGCCAGAAAAACACT
6BF CCTATAATCTCCACAGTGGGATTTACCCACTACAGAAATTATAGAGCCAGAAAAACACT
6BSP CCTATAATCTCCACAGTGGGATTTACCCACTACAGAAATTATAGAGCCAGAAAAACACT
19AH CCTATAATCTCCACAGTGGGATTTACCCACTACAGAAATTATAGAGCCAGAAAAACACT
23FPO CCTATAATCTCCACAGTGGGATTTACCCACTACAGAAATTATAGAGCCAGAAAAACACT
19FTW CCTATAATCTCCACAGTGGGATTTACCCACTACAGAAATTATAGAGCCAGAAAAACACT
9VSP CCTATAATCTCCACAGTGGGATTTACCCACTACAGAAATTATAGAGCCAGAAAAACACT
TIGR4 CCTATAATCTCCACAGTGGGATTTACCCACTACAGAAATTATAGAGCCAGAAAAACACT
23FTW CCTATAATCTCCACAGTGGGATTTACCCACTACAGAAATTATAGAGCCAGAAAAACACT

14CSR TTTGTTCACTAGCAGAAACTAGAGAGCAGAAGTGTTTTCTGTTTACCCAAAAC
670 TTTGTTCACTAGCAGAAACTAGAGAGCAGAAGTGTTTTCTGTTTACCCAAAAC
6BF TTTGTTCACTAGCAGAAACTAGAGAGCAGAAGTGTTTTCTGTTTACCCAAAAC
6BSP TTTGTTCACTAGCAGAAACTAGAGAGCAGAAGTGTTTTCTGTTTACCCAAAAC
19AH TTTGTTCACTAGCAGAAACTAGAGAGCAGAAGTGTTTTCTGTTTACCCAAAAC
23FPO TTTGTTCACTAGCAGAAACTAGAGAGCAGAAGTGTTTTCTGTTTACCCAAAAC
19FTW TTTGTTCACTAGCAGAAACTAGAGAGCAGAAGTGTTTTCTGTTTACCCAAAAC
9VSP TTTGTTCACTAGCAGAAACTAGAGAGCAGAAGTGTTTTCTGTTTACCCAAAAC
TIGR4 TTTGTTCACTAGCAGAAACTAGAGAGCAGAAGTGTTTTCTGTTTACCCAAAAC
23FTW TTTGTTCACTAGCAGAAACTAGAGAGCAGAAGTGTTTTCTGTTTACCCAAAAC

14CSR TGGGAAATATGGGGATAAGAATAGAGATGGCTTAGGAAGCCCTTTTTGTGTGTAGACAG
670 TGGGAAATATGGGGATAAGAATAGAGATGGCTTAGGAAGCCCTTTTTGTGTGTAGACAG
6BF TGGGAAATATGGGGATAAGAATAGAGATGGCTTAGGAAGCCCTTTTTGTGTGTAGACAG
6BSP TGGGAAATATGGGGATAAGAATAGAGATGGCTTAGGAAGCCCTTTTTGTGTGTAGACAG
19AH TGGGAAATATGGGGATAAGAATAGAGATGGCTTAGGAAGCCCTTTTTGTGTGTAGACAG
23FPO TGGGAAATATGGGGATAAGAATAGAGATGGCTTAGGAAGCCCTTTTTGTGTGTAGACAG
19FTW TGGGAAATATGGGGATAAGAATAGAGATGGCTTAGGAAGCCCTTTTTGTGTGTAGACAG
9VSP TGGGAAATATGGGGATAAGAATAGAGATGGCTTAGGAAGCCCTTTTTGTGTGTAGACAG
TIGR4 TGGGAAATATGGGGATAAGAATAGAGATGGCTTAGGAAGCCCTTTTTGTGTGTAGACAG
23FTW TGGGAAATATGGGGATAAGAATAGAGATGGCTTAGGAAGCCCTTTTTGTGTGTAGACAG

14CSR TACGATGAAC TTATAACAAATAGTGAGCCTTTT TAGCAATCATTGCGACCCGTTTGTCAA
670 TACGATGAAC TTATAACAAATAGTGAGCCTTTT TAGCAATCATTGCGACCCGTTTGTCAA
6BF TACGATGAAC TTATAACAAATAGTGAGCCTTTT TAGCAATCATTGCGACCCGTTTGTCAA
6BSP TACGATGAAC TTATAACAAATAGTGAGCCTTTT TAGCAATCATTGCGACCCGTTTGTCAA
19AH TACGATGAAC TTATAACAAATAGTGAGCCTTTT TAGCAATCATTGCGACCCGTTTGTCAA
23FPO TACGATGAAC TTATAACAAATAGTGAGCCTTTT TAGCAATCATTGCGACCCGTTTGTCAA
19FTW TACGATGAAC TTATAACAAATAGTGAGCCTTTT TAGCAATCATTGCGACCCGTTTGTCAA
9VSP TACGATGAAC TTATAACAAATAGTGAGCCTTTT TAGCAATCATTGCGACCCGTTTGTCAA
TIGR4 TACGATGAAC TTATAACAAATAGTGAGCCTTTT TAGCAATCATTGCGACCCGTTTGTCAA
23FTW TACGATGAAC TTATAACAAATAGTGAGCCTTTT TAGCAATCATTGCGACCCGTTTGTCAA

Figure 196A

PCT/US2005/027239

14CSR AAGCCTCTTTTCGGATATCTACAATTGTCTGATAGATGAGACGCTGTTGGCTAACATGCA
670 AAGCCTCTTTTCGGATATCTACAATTGTCTGATAGATGAGACGCTGTTGGCTAACATGCA
6BF AAGCCTCTTTTCGGATATCTACAATTGTCTGATAGATGAGACGCTGTTGGCTAACATGCA
6BSP AAGCCTCTTTTCGGATATCTACAATTGTCTGATAGATGAGACGCTGTTGGCTAACATGCA
19AH AAGCCTCTTTTCGGATATCTACAATTGTCTGATAGATGAGACGCTGTTGGCTAACATGCA
23FPO AAGCCTCTTTTCGGATATCTACAATTGTCTGATAGATGAGACGCTGTTGGCTAACATGCA
19FTW AAGCCTCTTTTCGGATATCTACAATTGTCTGATAGATGAGACGCTGTTGGCTAACATGCA
9VSP AAGCCTCTTTTCGGATATCTACAATTGTCTGATAGATGAGACGCTGTTGGCTAACATGCA
TIGR4 AAGCCTCTTTTCGGATATCTACAATTGTCTGATAGATGAGACGCTGTTGGCTAACATGCA
23FTW AAGCCTCTTTTCGGATATCTACAATTGTCTGATAGATGAGACGCTGTTGGCTAACATGCA

14CSR AATCTAAGGCAATCGTCAAAAAGTGATGTTCCCTTTGGGATACTGCTTTTTAACGTAAG
670 AATCTAAGGCAATCGTCAAAAAGTGATGTTCCCTTTGGGATACTGCTTTTTAACGTAAG
6BF AATCTAAGGCAATCGTCAAAAAGTGATGTTCCCTTTGGGATACTGCTTTTTAACGTAAG
6BSP AATCTAAGGCAATCGTCAAAAAGTGATGTTCCCTTTGGGATACTGCTTTTTAACGTAAG
19AH AATCTAAGGCAATCGTCAAAAAGTGATGTTCCCTTTGGGATACTGCTTTTTAACGTAAG
23FPO AATCTAAGGCAATCGTCAAAAAGTGATGTTCCCTTTGGGATACTGCTTTTTAACGTAAG
19FTW AATCTAAGGCAATCGTCAAAAAGTGATGTTCCCTTTGGGATACTGCTTTTTAACGTAAG
9VSP AATCTAAGGCAATCGTCAAAAAGTGATGTTCCCTTTGGGATACTGCTTTTTAACGTAAG
TIGR4 AATCTAAGGCAATCGTCAAAAAGTGATGTTCCCTTTGGGATACTGCTTTTTAACGTAAG
23FTW AATCTAAGGCAATCGTCAAAAAGTGATGTTCCCTTTGGGATACTGCTTTTTAACGTAAG

14CSR GCAGGTATTCTTTTCGTTGTAATAATAATCAATGGCTCTGTCAAATGCTCCTCTGAAGGAG
670 GCAGGTATTCTTTTCGTTGTAATAATAATCAATGGCTCTGTCAAATGCTCCTCTGAAGGAG
6BF GCAGGTATTCTTTTCGTTGTAATAATAATCAATGGCTCTGTCAAATGCTCCTCTGAAGGAG
6BSP GCAGGTATTCTTTTCGTTGTAATAATAATCAATGGCTCTGTCAAATGCTCCTCTGAAGGAG
19AH GCAGGTATTCTTTTCGTTGTAATAATAATCAATGGCTCTGTCAAATGCTCCTCTGAAGGAG
23FPO GCAGGTATTCTTTTCGTTGTAATAATAATCAATGGCTCTGTCAAATGCTCCTCTGAAGGAG
19FTW GCAGGTATTCTTTTCGTTGTAATAATAATCAATGGCTCTGTCAAATGCTCCTCTGAAGGAG
9VSP GCAGGTATTCTTTTCGTTGTAATAATAATCAATGGCTCTGTCAAATGCTCCTCTGAAGGAG
TIGR4 GCAGGTATTCTTTTCGTTGTAATAATAATCAATGGCTCTGTCAAATGCTCCTCTGAAGGAG
23FTW GCAGGTATTCTTTTCGTTGTAATAATAATCAATGGCTCTGTCAAATGCTCCTCTGAAGGAG

14CSR GAGGACTAATTAGAATATTGTATCCTGTAACAGAGGCCAAGTTTGTGTCAGTAAAATCCGTA
670 GAGGACTAATTAGAATATTGTATCCTGTAACAGAGGCCAAGTTTGTGTCAGTAAAATCCGTA
6BF GAGGACTAATTAGAATATTGTATCCTGTAACAGAGGCCAAGTTTGTGTCAGTAAAATCCGTA
6BSP GAGGACTAATTAGAATATTGTATCCTGTAACAGAGGCCAAGTTTGTGTCAGTAAAATCCGTA
19AH GAGGACTAATTAGAATATTGTATCCTGTAACAGAGGCCAAGTTTGTGTCAGTAAAATCCGTA
23FPO GAGGACTAATTAGAATATTGTATCCTGTAACAGAGGCCAAGTTTGTGTCAGTAAAATCCGTA
19FTW GAGGACTAATTAGAATATTGTATCCTGTAACAGAGGCCAAGTTTGTGTCAGTAAAATCCGTA
9VSP GAGGACTAATTAGAATATTGTATCCTGTAACAGAGGCCAAGTTTGTGTCAGTAAAATCCGTA
TIGR4 GAGGACTAATTAGAATATTGTATCCTGTAACAGAGGCCAAGTTTGTGTCAGTAAAATCCGTA
23FTW GAGGACTAATTAGAATATTGTATCCTGTAACAGAGGCCAAGTTTGTGTCAGTAAAATCCGTA

14CSR AAATAATGGACTTTATTAAGTTTACATCTGCTTGATTATTTAAAATGATAAAAATCGGGA
670 AAATAATGGACTTTATTAAGTTTACATCTGCTTGATTATTTAAAATGATAAAAATCGGGA
6BF AAATAATGGACTTTATTAAGTTTACATCTGCTTGATTATTTAAAATGATAAAAATCGGGA
6BSP AAATAATGGACTTTATTAAGTTTACATCTGCTTGATTATTTAAAATGATAAAAATCGGGA
19AH AAATAATGGACTTTATTAAGTTTACATCTGCTTGATTATTTAAAATGATAAAAATCGGGA
23FPO AAATAATGGACTTTATTAAGTTTACATCTGCTTGATTATTTAAAATGATAAAAATCGGGA
19FTW AAATAATGGACTTTATTAAGTTTACATCTGCTTGATTATTTAAAATGATAAAAATCGGGA
9VSP AAATAATGGACTTTATTAAGTTTACATCTGCTTGATTATTTAAAATGATAAAAATCGGGA
TIGR4 AAATAATGGACTTTATTAAGTTTACATCTGCTTGATTATTTAAAATGATAAAAATCGGGA
23FTW AAATAATGGACTTTATTAAGTTTACATCTGCTTGATTATTTAAAATGATAAAAATCGGGA

Figure 196B

PCT/US05/27239

14CSR TAGCAGGTAGTGAGGAAAAGATGGTTTCTGTCAAGTAGAGTGAGAAAAGGTACAGCCGAT
670 TAGCAGGTAGTGAGGAAAAGATGGTTTCTGTCAAGTAGAGTGAGAAAAGGTACAGCCGAT
6BF TAGCAGGTAGTGAGGAAAAGATGGTTTCTGTCAAGTAGAGTGAGAAAAGGTACAGCCGAT
6BSP TAGCAGGTAGTGAGGAAAAGATGGTTTCTGTCAAGTAGAGTGAGAAAAGGTACAGCCGAT
19AH TAGCAGGTAGTGAGGAAAAGATGGTTTCTGTCAAGTAGAGTGAGAAAAGGTACAGCCGAT
23FPO TAGCAGGTAGTGAGGAAAAGATGGTTTCTGTCAAGTAGAGTGAGAAAAGGTACAGCCGAT
19FTW TAGCAGGTAGTGAGGAAAAGATGGTTTCTGTCAAGTAGAGTGAGAAAAGGTACAGCCGAT
9VSP TAGCAGGTAGTGAGGAAAAGATGGTTTCTGTCAAGTAGAGTGAGAAAAGGTACAGCCGAT
TIGR4 TAGCAGGTAGTGAGGAAAAGATGGTTTCTGTCAAGTAGAGTGAGAAAAGGTACAGCCGAT
23FTW TAGCAGGTAGTGAGGAAAAGATGGTTTCTGTCAAGTAGAGTGAGAAAAGGTACAGCCGAT

14CSR GCTGGTCGATAAECTCCTTCAATCTTCTGCTCAGTCATCCACTCTTGAACAATTGCTTTCG
670 GCTGGTCGATAAECTCCTTCAATCTTCTGCTCAGTCATCCACTCTTGAACAATTGCTTTCG
6BF GCTGGTCGATAAECTCCTTCAATCTTCTGCTCAGTCATCCACTCTTGAACAATTGCTTTCG
6BSP GCTGGTCGATAAECTCCTTCAATCTTCTGCTCAGTCATCCACTCTTGAACAATTGCTTTCG
19AH GCTGGTCGATAAECTCCTTCAATCTTCTGCTCAGTCATCCACTCTTGAACAATTGCTTTCG
23FPO GCTGGTCGATAAECTCCTTCAATCTTCTGCTCAGTCATCCACTCTTGAACAATTGCTTTCG
19FTW GCTGGTCGATAAECTCCTTCAATCTTCTGCTCAGTCATCCACTCTTGAACAATTGCTTTCG
9VSP GCTGGTCGATAAECTCCTTCAATCTTCTGCTCAGTCATCCACTCTTGAACAATTGCTTTCG
TIGR4 GCTGGTCGATAAECTCCTTCAATCTTCTGCTCAGTCATCCACTCTTGAACAATTGCTTTCG
23FTW GCTGGTCGATAAECTCCTTCAATCTTCTGCTCAGTCATCCACTCTTGAACAATTGCTTTCG

14CSR AAATATGATACAGTGGCTTGTGCGCTTCAATCCCATAATGTTTCGTAATAATTATAATAGG
670 AAATATGATACAGTGGCTTGTGCGCTTCAATCCCATAATGTTTCGTAATAATTATAATAGG
6BF AAATATGATACAGTGGCTTGTGCGCTTCAATCCCATAATGTTTCGTAATAATTATAATAGG
6BSP AAATATGATACAGTGGCTTGTGCGCTTCAATCCCATAATGTTTCGTAATAATTATAATAGG
19AH AAATATGATACAGTGGCTTGTGCGCTTCAATCCCATAATGTTTCGTAATAATTATAATAGG
23FPO AAATATGATACAGTGGCTTGTGCGCTTCAATCCCATAATGTTTCGTAATAATTATAATAGG
19FTW AAATATGATACAGTGGCTTGTGCGCTTCAATCCCATAATGTTTCGTAATAATTATAATAGG
9VSP AAATATGATACAGTGGCTTGTGCGCTTCAATCCCATAATGTTTCGTAATAATTATAATAGG
TIGR4 AAATATGATACAGTGGCTTGTGCGCTTCAATCCCATAATGTTTCGTAATAATTATAATAGG
23FTW AAATATGATACAGTGGCTTGTGCGCTTCAATCCCATAATGTTTCGTAATAATTATAATAGG

14CSR GAACTAGATTTTGTAAACCAAACAAAACGTTCTTGTTAAGAAAAGTCAGTGCTGTTAAAA
670 GAACTAGATTTTGTAAACCAAACAAAACGTTCTTGTTAAGAAAAGTCAGTGCTGTTAAAA
6BF GAACTAGATTTTGTAAACCAAACAAAACGTTCTTGTTAAGAAAAGTCAGTGCTGTTAAAA
6BSP GAACTAGATTTTGTAAACCAAACAAAACGTTCTTGTTAAGAAAAGTCAGTGCTGTTAAAA
19AH GAACTAGATTTTGTAAACCAAACAAAACGTTCTTGTTAAGAAAAGTCAGTGCTGTTAAAA
23FPO GAACTAGATTTTGTAAACCAAACAAAACGTTCTTGTTAAGAAAAGTCAGTGCTGTTAAAA
19FTW GAACTAGATTTTGTAAACCAAACAAAACGTTCTTGTTAAGAAAAGTCAGTGCTGTTAAAA
9VSP GAACTAGATTTTGTAAACCAAACAAAACGTTCTTGTTAAGAAAAGTCAGTGCTGTTAAAA
TIGR4 GAACTAGATTTTGTAAACCAAACAAAACGTTCTTGTTAAGAAAAGTCAGTGCTGTTAAAA
23FTW GAACTAGATTTTGTAAACCAAACAAAACGTTCTTGTTAAGAAAAGTCAGTGCTGTTAAAA

14CSR AAGAAAGAGAATTCGAAATGTCATTTCCCTAAGATATTCTTGAACCTGGATAGTAGATGCT
670 AAGAAAGAGAATTCGAAATGTCATTTCCCTAAGATATTCTTGAACCTGGATAGTAGATGCT
6BF AAGAAAGAGAATTCGAAATGTCATTTCCCTAAGATATTCTTGAACCTGGATAGTAGATGCT
6BSP AAGAAAGAGAATTCGAAATGTCATTTCCCTAAGATATTCTTGAACCTGGATAGTAGATGCT
19AH AAGAAAGAGAATTCGAAATGTCATTTCCCTAAGATATTCTTGAACCTGGATAGTAGATGCT
23FPO AAGAAAGAGAATTCGAAATGTCATTTCCCTAAGATATTCTTGAACCTGGATAGTAGATGCT
19FTW AAGAAAGAGAATTCGAAATGTCATTTCCCTAAGATATTCTTGAACCTGGATAGTAGATGCT
9VSP AAGAAAGAGAATTCGAAATGTCATTTCCCTAAGATATTCTTGAACCTGGATAGTAGATGCT
TIGR4 AAGAAAGAGAATTCGAAATGTCATTTCCCTAAGATATTCTTGAACCTGGATAGTAGATGCT
23FTW AAGAAAGAGAATTCGAAATGTCATTTCCCTAAGATATTCTTGAACCTGGATAGTAGATGCT

Figure 196C

PCT/US05/27239

396/487

14CSR TTCCTCTTGTATGCTGAAGAATCAGTTGAATAGTATGAGTCTTTTTTCTTGATTCATT
670 TTCCTCTTGTATGCTGAAGAATCAGTTGAATAGTATGAGTCTTTTTTCTTGATTCATT
6BF TTCCTCTTGTATGCTGAAGAATCAGTTGAATAGTATGAGTCTTTTTTCTTGATTCATT
6BSP TTCCTCTTGTATGCTGAAGAATCAGTTGAATAGTATGAGTCTTTTTTCTTGATTCATT
19AH TTCCTCTTGTATGCTGAAGAATCAGTTGAATAGTATGAGTCTTTTTTCTTGATTCATT
23FPO TTCCTCTTGTATGCTGAAGAATCAGTTGAATAGTATGAGTCTTTTTTCTTGATTCATT
19FTW TTCCTCTTGTATGCTGAAGAATCAGTTGAATAGTATGAGTCTTTTTTCTTGATTCATT
9VSP TTCCTCTTGTATGCTGAAGAATCAGTTGAATAGTATGAGTCTTTTTTCTTGATTCATT
TIGR4 TTCCTCTTGTATGCTGAAGAATCAGTTGAATAGTATGAGTCTTTTTTCTTGATTCATT
23FTW TTCCTCTTGTATGCTGAAGAATCAGTTGAATAGTATGAGTCTTTTTTCTTGATTCATT

14CSR TGTCCCTGGAAAACGAAGAATTAGCAGAACAATAAACCAAAAAGATATAATCCAGTTCTT
670 TGTCCCTGGAAAACGAAGAATTAGCAGAACAATAAACCAAAAAGATATAATCCAGTTCTT
6BF TGTCCCTGGAAAACGAAGAATTAGCAGAACAATAAACCAAAAAGATATAATCCAGTTCTT
6BSP TGTCCCTGGAAAACGAAGAATTAGCAGAACAATAAACCAAAAAGATATAATCCAGTTCTT
19AH TGTCCCTGGAAAACGAAGAATTAGCAGAACAATAAACCAAAAAGATATAATCCAGTTCTT
23FPO TGTCCCTGGAAAACGAAGAATTAGCAGAACAATAAACCAAAAAGATATAATCCAGTTCTT
19FTW TGTCCCTGGAAAACGAAGAATTAGCAGAACAATAAACCAAAAAGATATAATCCAGTTCTT
9VSP TGTCCCTGGAAAACGAAGAATTAGCAGAACAATAAACCAAAAAGATATAATCCAGTTCTT
TIGR4 TGTCCCTGGAAAACGAAGAATTAGCAGAACAATAAACCAAAAAGATATAATCCAGTTCTT
23FTW TGTCCCTGGAAAACGAAGAATTAGCAGAACAATAAACCAAAAAGATATAATCCAGTTCTT

14CSR CCTGAGTAAAAGTCATGTTGGCATGTGGCTCTAAGTAAGTTTGGCAATGTTCCATCAAAA
670 CCTGAGTAAAAGTCATGTTGGCATGTGGCTCTAAGTAAGTTTGGCAATGTTCCATCAAAA
6BF CCTGAGTAAAAGTCATGTTGGCATGTGGCTCTAAGTAAGTTTGGCAATGTTCCATCAAAA
6BSP CCTGAGTAAAAGTCATGTTGGCATGTGGCTCTAAGTAAGTTTGGCAATGTTCCATCAAAA
19AH CCTGAGTAAAAGTCATGTTGGCATGTGGCTCTAAGTAAGTTTGGCAATGTTCCATCAAAA
23FPO CCTGAGTAAAAGTCATGTTGGCATGTGGCTCTAAGTAAGTTTGGCAATGTTCCATCAAAA
19FTW CCTGAGTAAAAGTCATGTTGGCATGTGGCTCTAAGTAAGTTTGGCAATGTTCCATCAAAA
9VSP CCTGAGTAAAAGTCATGTTGGCATGTGGCTCTAAGTAAGTTTGGCAATGTTCCATCAAAA
TIGR4 CCTGAGTAAAAGTCATGTTGGCATGTGGCTCTAAGTAAGTTTGGCAATGTTCCATCAAAA
23FTW CCTGAGTAAAAGTCATGTTGGCATGTGGCTCTAAGTAAGTTTGGCAATGTTCCATCAAAA

14CSR TCGGATACATAAAGAGGTTTTTAAATTTTCAAACCTCTTTGGACTCAGGGAACCTCAAGTG
670 TCGGATACATAAAGAGGTTTTTAAATTTTCAAACCTCTTTGGACTCAGGGAACCTCAAGTG
6BF TCGGATACATAAAGAGGTTTTTAAATTTTCAAACCTCTTTGGACTCAGGGAACCTCAAGTG
6BSP TCGGATACATAAAGAGGTTTTTAAATTTTCAAACCTCTTTGGACTCAGGGAACCTCAAGTG
19AH TCGGATACATAAAGAGGTTTTTAAATTTTCAAACCTCTTTGGACTCAGGGAACCTCAAGTG
23FPO TCGGATACATAAAGAGGTTTTTAAATTTTCAAACCTCTTTGGACTCAGGGAACCTCAAGTG
19FTW TCGGATACATAAAGAGGTTTTTAAATTTTCAAACCTCTTTGGACTCAGGGAACCTCAAGTG
9VSP TCGGATACATAAAGAGGTTTTTAAATTTTCAAACCTCTTTGGACTCAGGGAACCTCAAGTG
TIGR4 TCGGATACATAAAGAGGTTTTTAAATTTTCAAACCTCTTTGGACTCAGGGAACCTCAAGTG
23FTW TCGGATACATAAAGAGGTTTTTAAATTTTCAAACCTCTTTGGACTCAGGGAACCTCAAGTG

14CSR GAAATTCCTGACGTTTCCAAGTGAGTGCCACTAGTATGCTAAAATGAACATACTCGTCAG
670 GAAATTCCTGACGTTTCCAAGTGAGTGCCACTAGTATGCTAAAATGAACATACTCGTCAG
6BF GAAATTCCTGACGTTTCCAAGTGAGTGCCACTAGTATGCTAAAATGAACATACTCGTCAG
6BSP GAAATTCCTGACGTTTCCAAGTGAGTGCCACTAGTATGCTAAAATGAACATACTCGTCAG
19AH GAAATTCCTGACGTTTCCAAGTGAGTGCCACTAGTATGCTAAAATGAACATACTCGTCAG
23FPO GAAATTCCTGACGTTTCCAAGTGAGTGCCACTAGTATGCTAAAATGAACATACTCGTCAG
19FTW GAAATTCCTGACGTTTCCAAGTGAGTGCCACTAGTATGCTAAAATGAACATACTCGTCAG
9VSP GAAATTCCTGACGTTTCCAAGTGAGTGCCACTAGTATGCTAAAATGAACATACTCGTCAG
TIGR4 GAAATTCCTGACGTTTCCAAGTGAGTGCCACTAGTATGCTAAAATGAACATACTCGTCAG
23FTW GAAATTCCTGACGTTTCCAAGTGAGTGCCACTAGTATGCTAAAATGAACATACTCGTCAG

Figure 196D

PCT/US05/27239 397/487

14CSR GTGTGATTTCTAACAGTTCATGACTGAGTTGAGAATTAGACTGCACAATCATATGTGTGA
670 GTGTGATTTCTAACAGTTCATGACTGAGTTGAGAATTAGACTGCACAATCATATGTGTGA
6BF GTGTGATTTCTAACAGTTCATGACTGAGTTGAGAATTAGACTGCACAATCATATGTGTGA
6BSP GTGTGATTTCTAACAGTTCATGACTGAGTTGAGAATTAGACTGCACAATCATATGTGTGA
19AH GTGTGATTTCTAACAGTTCATGACTGAGTTGAGAATTAGACTGCACAATCATATGTGTGA
23FPO GTGTGATTTCTAACAGTTCATGACTGAGTTGAGAATTAGACTGCACAATCATATGTGTGA
19FTW GTGTGATTTCTAACAGTTCATGACTGAGTTGAGAATTAGACTGCACAATCATATGTGTGA
9VSP GTGTGATTTCTAACAGTTCATGACTGAGTTGAGAATTAGACTGCACAATCATATGTGTGA
TIGR4 GTGTGATTTCTAACAGTTCATGACTGAGTTGAGAATTAGACTGCACAATCATATGTGTGA
23FTW GTGTGATTTCTAACAGTTCATGACTGAGTTGAGAATTAGACTGCACAATCATATGTGTGA

14CSR CCCAATCCATACTTCCATCATTCAAATCATAAATCTCAATACCCAAAATGAAACTGGAGGA
670 CCCAATCCATACTTCCATCATTCAAATCATAAATCTCAATACCCAAAATGAAACTGGAGGA
6BF CCCAATCCATACTTCCATCATTCAAATCATAAATCTCAATACCCAAAATGAAACTGGAGGA
6BSP CCCAATCCATACTTCCATCATTCAAATCATAAATCTCAATACCCAAAATGAAACTGGAGGA
19AH CCCAATCCATACTTCCATCATTCAAATCATAAATCTCAATACCCAAAATGAAACTGGAGGA
23FPO CCCAATCCATACTTCCATCATTCAAATCATAAATCTCAATACCCAAAATGAAACTGGAGGA
19FTW CCCAATCCATACTTCCATCATTCAAATCATAAATCTCAATACCCAAAATGAAACTGGAGGA
9VSP CCCAATCCATACTTCCATCATTCAAATCATAAATCTCAATACCCAAAATGAAACTGGAGGA
TIGR4 CCCAATCCATACTTCCATCATTCAAATCATAAATCTCAATACCCAAAATGAAACTGGAGGA
23FTW CCCAATCCATACTTCCATCATTCAAATCATAAATCTCAATACCCAAAATGAAACTGGAGGA

14CSR GTGCAATTAAAAAACGAATGCGATATT CAGGACCAACTACTTGATTTTTT CACAAGGTCCA
670 GTGCAATTAAAAAACGAATGCGATATT CAGGACCAACTACTTGATTTTTT CACAAGGTCCA
6BF GTGCAATTAAAAAACGAATGCGATATT CAGGACCAACTACTTGATTTTTT CACAAGGTCCA
6BSP GTGCAATTAAAAAACGAATGCGATATT CAGGACCAACTACTTGATTTTTT CACAAGGTCCA
19AH GTGCAATTAAAAAACGAATGCGATATT CAGGACCAACTACTTGATTTTTT CACAAGGTCCA
23FPO GTGCAATTAAAAAACGAATGCGATATT CAGGACCAACTACTTGATTTTTT CACAAGGTCCA
19FTW GTGCAATTAAAAAACGAATGCGATATT CAGGACCAACTACTTGATTTTTT CACAAGGTCCA
9VSP GTGCAATTAAAAAACGAATGCGATATT CAGGACCAACTACTTGATTTTTT -CACAAGGTCCA
TIGR4 GTGCAATTAAAAAACGAATGCGATATT CAGGACCAACTACTTGATTTTTT CACAAGGTCCA
23FTW GTGCAATTAAAAAACGAATGCGATATT CAGGACCAACTACTTGATTTTTT CACAAGGTCCA

14CSR AACCTACTGAACGTAGTAACAAGCCACACTTTTGTGTCGACGCGGTAGCCTGTTGCGATGG
670 AACCTACTGAACGTAGTAACAAGCCACACTTTTGTGTCGACGCGGTAGCCTGTTGCGATGG
6BF AACCTACTGAACGTAGTAACAAGCCACACTTTTGTGTCGACGCGGTAGCCTGTTGCGATGG
6BSP AACCTACTGAACGTAGTAACAAGCCACACTTTTGTGTCGACGCGGTAGCCTGTTGCGATGG
19AH AACCTACTGAACGTAGTAACAAGCCACACTTTTGTGTCGACGCGGTAGCCTGTTGCGATGG
23FPO AACCTACTGAACGTAGTAACAAGCCACACTTTTGTGTCGACGCGGTAGCCTGTTGCGATGG
19FTW AACCTACTGAACGTAGTAACAAGCCACACTTTTGTGTCGACGCGGTAGCCTGTTGCGATGG
9VSP AACCTACTGAACGTAGTAACAAGCCACACTTTTGTGTCGACGCGGTAGCCTGTTGCGATGG
TIGR4 AACCTACTGAACGTAGTAACAAGCCACACTTTTGTGTCGACGCGGTAGCCTGTTGCGATGG
23FTW AACCTACTGAACGTAGTAACAAGCCACACTTTTGTGTCGACGCGGTAGCCTGTTGCGATGG

14CSR AAATATACTCTTTTTGTGTAATTCGTTAAAGCTTTGATTACCTTGTAGTAGAAGAAGC
670 AAATATACTCTTTTTGTGTAATTCGTTAAAGCTTTGATTACCTTGTAGTAGAAGAAGC
6BF AAATATACTCTTTTTGTGTAATTCGTTAAAGCTTTGATTACCTTGTAGTAGAAGAAGC
6BSP AAATATACTCTTTTTGTGTAATTCGTTAAAGCTTTGATTACCTTGTAGTAGAAGAAGC
19AH AAATATACTCTTTTTGTGTAATTCGTTAAAGCTTTGATTACCTTGTAGTAGAAGAAGC
23FPO AAATATACTCTTTTTGTGTAATTCGTTAAAGCTTTGATTACCTTGTAGTAGAAGAAGC
19FTW AAATATACTCTTTTTGTGTAATTCGTTAAAGCTTTGATTACCTTGTAGTAGAAGAAGC
9VSP AAATATACTCTTTTTGTGTAATTCGTTAAAGCTTTGATTACCTTGTAGTAGAAGAAGC
TIGR4 AAATATACTCTTTTTGTGTAATTCGTTAAAGCTTTGATTACCTTGTAGTAGAAGAAGC
23FTW AAATATACTCTTTTTGTGTAATTCGTTAAAGCTTTGATTACCTTGTAGTAGAAGAAGC

Figure 196E

14CSR GGAGTATTTTTAAAATAGTTGATTGGTTATAAAGCTGATGGAAGTAATAATTCGTTTGAT
670 GGAGTATTTTTAAAATAGTTGATTGGTTATAAAGCTGATGGAAGTAATAATTCGTTTGAT
6BF GGAGTATTTTTAAAATAGTTGATTGGTTATAAAGCTGATGGAAGTAATAATTCGTTTGAT
6BSP GGAGTATTTTTAAAATAGTTGATTGGTTATAAAGCTGATGGAAGTAATAATTCGTTTGAT
19AH GGAGTATTTTTAAAATAGTTGATTGGTTATAAAGCTGATGGAAGTAATAATTCGTTTGAT
23FPO GGAGTATTTTTAAAATAGTTGATTGGTTATAAAGCTGATGGAAGTAATAATTCGTTTGAT
19FTW GGAGTATTTTTAAAATAGTTGATTGGTTATAAAGCTGATGGAAGTAATAATTCGTTTGAT
9VSP GGAGTATTTTTAAAATAGTTGATTGGTTATAAAGCTGATGGAAGTAATAATTCGTTTGAT
TIGR4 GGAGTATTTTTAAAATAGTTGATTGGTTATAAAGCTGATGGAAGTAATAATTCGTTTGAT
23FTW GGAGTATTTTTAAAATAGTTGATTGGTTATAAAGCTGATGGAAGTAATAATTCGTTTGAT

14CSR GAGAATGGTGTTCGATTAATTGAACCTGTTGCGTATCTAAATTAATGTCAACTCTTCT
670 GAGAATGGTGTTCGATTAATTGAACCTGTTGCGTATCTAAATTAATGTCAACTCTTCT
6BF GAGAATGGTGTTCGATTAATTGAACCTGTTGCGTATCTAAATTAATGTCAACTCTTCT
6BSP GAGAATGGTGTTCGATTAATTGAACCTGTTGCGTATCTAAATTAATGTCAACTCTTCT
19AH GAGAATGGTGTTCGATTAATTGAACCTGTTGCGTATCTAAATTAATGTCAACTCTTCT
23FPO GAGAATGGTGTTCGATTAATTGAACCTGTTGCGTATCTAAATTAATGTCAACTCTTCT
19FTW GAGAATGGTGTTCGATTAATTGAACCTGTTGCGTATCTAAATTAATGTCAACTCTTCT
9VSP GAGAATGGTGTTCGATTAATTGAACCTGTTGCGTATCTAAATTAATGTCAACTCTTCT
TIGR4 GAGAATGGTGTTCGATTAATTGAACCTGTTGCGTATCTAAATTAATGTCAACTCTTCT
23FTW GAGAATGGTGTTCGATTAATTGAACCTGTTGCGTATCTAAATTAATGTCAACTCTTCT

14CSR CGAATGTTTCTTGTAAATCCCTGCAAAATGCTTAGGAGACTTTTAGATTGTAATGAAGTTA
670 CGAATGTTTCTTGTAAATCCCTGCAAAATGCTTAGGAGACTTTTAGATTGTAATGAAGTTA
6BF CGAATGTTTCTTGTAAATCCCTGCAAAATGCTTAGGAGACTTTTAGATTGTAATGAAGTTA
6BSP CGAATGTTTCTTGTAAATCCCTGCAAAATGCTTAGGAGACTTTTAGATTGTAATGAAGTTA
19AH CGAATGTTTCTTGTAAATCCCTGCAAAATGCTTAGGAGACTTTTAGATTGTAATGAAGTTA
23FPO CGAATGTTTCTTGTAAATCCCTGCAAAATGCTTAGGAGACTTTTAGATTGTAATGAAGTTA
19FTW CGAATGTTTCTTGTAAATCCCTGCAAAATGCTTAGGAGACTTTTAGATTGTAATGAAGTTA
9VSP CGAATGTTTCTTGTAAATCCCTGCAAAATGCTTAGGAGACTTTTAGATTGTAATGAAGTTA
TIGR4 CGAATGTTTCTTGTAAATCCCTGCAAAATGCTTAGGAGACTTTTAGATTGTAATGAAGTTA
23FTW CGAATGTTTCTTGTAAATCCCTGCAAAATGCTTAGGAGACTTTTAGATTGTAATGAAGTTA

14CSR AAGTAGACAGTTCATCTAGTTCAATAGACCGAATATCCAATAATATATTTAAAATGGTAA
670 AAGTAGACAGTTCATCTAGTTCAATAGACCGAATATCCAATAATATATTTAAAATGGTAA
6BF AAGTAGACAGTTCATCTAGTTCAATAGACCGAATATCCAATAATATATTTAAAATGGTAA
6BSP AAGTAGACAGTTCATCTAGTTCAATAGACCGAATATCCAATAATATATTTAAAATGGTAA
19AH AAGTAGACAGTTCATCTAGTTCAATAGACCGAATATCCAATAATATATTTAAAATGGTAA
23FPO AAGTAGACAGTTCATCTAGTTCAATAGACCGAATATCCAATAATATATTTAAAATGGTAA
19FTW AAGTAGACAGTTCATCTAGTTCAATAGACCGAATATCCAATAATATATTTAAAATGGTAA
9VSP AAGTAGACAGTTCATCTAGTTCAATAGACCGAATATCCAATAATATATTTAAAATGGTAA
TIGR4 AAGTAGACAGTTCATCTAGTTCAATAGACCGAATATCCAATAATATATTTAAAATGGTAA
23FTW AAGTAGACAGTTCATCTAGTTCAATAGACCGAATATCCAATAATATATTTAAAATGGTAA

14CSR TTTTATCTGTAATTCCTTTTTCAATGTATTTGTTTAGCATAGTTACCGAATCTTAGTTGC
670 TTTTATCTGTAATTCCTTTTTCAATGTATTTGTTTAGCATAGTTACCGAATCTTAGTTGC
6BF TTTTATCTGTAATTCCTTTTTCAATGTATTTGTTTAGCATAGTTACCGAATCTTAGTTGC
6BSP TTTTATCTGTAATTCCTTTTTCAATGTATTTGTTTAGCATAGTTACCGAATCTTAGTTGC
19AH TTTTATCTGTAATTCCTTTTTCAATGTATTTGTTTAGCATAGTTACCGAATCTTAGTTGC
23FPO TTTTATCTGTAATTCCTTTTTCAATGTATTTGTTTAGCATAGTTACCGAATCTTAGTTGC
19FTW TTTTATCTGTAATTCCTTTTTCAATGTATTTGTTTAGCATAGTTACCGAATCTTAGTTGC
9VSP TTTTATCTGTAATTCCTTTTTCAATGTATTTGTTTAGCATAGTTACCGAATCTTAGTTGC
TIGR4 TTTTATCTGTAATTCCTTTTTCAATGTATTTGTTTAGCATAGTTACCGAATCTTAGTTGC
23FTW TTTTATCTGTAATTCCTTTTTCAATGTATTTGTTTAGCATAGTTACCGAATCTTAGTTGC

Figure 196F

PCT/US05/27239 399/487

14CSR ATATAGATAATTTTAAATTATTATAATACAAAAGAACTAATGTCTTGTCAAAAAGGTTG
670 ATATAGATAATTTTAAATTATTATAATACAAAAGAACTAATGTCTTGTCAAAAAGGTTG
6BF ATATAGATAATTTTAAATTATTATAATACAAAAGAACTAATGTCTTGTCAAAAAGGTTG
6BSP ATATAGATAATTTTAAATTATTATAATACAAAAGAACTAATGTCTTGTCAAAAAGGTTG
19AH ATATAGATAATTTTAAATTATTATAATACAAAAGAACTAATGTCTTGTCAAAAAGGTTG
23FPO ATATAGATAATTTTAAATTATTATAATACAAAAGAACTAATGTCTTGTCAAAAAGGTTG
19FTW ATATAGATAATTTTAAATTATTATAATACAAAAGAACTAATGTCTTGTCAAAAAGGTTG
9VSP ATATAGATAATTTTAAATTATTATAATACAAAAGAACTAATGTCTTGTCAAAAAGGTTG
TIGR4 ATATAGATAATTTTAAATTATTATAATACAAAAGAACTAATGTCTTGTCAAAAAGGTTG
23FTW ATATAGATAATTTTAAATTATTATAATACAAAAGAACTAATGTCTTGTCAAAAAGGTTG

14CSR TGGAATTTCCGACTTTATTGATAAACAGCATGTAATAAAAAGGCATTTTAAAGATAGTAA
670 TGGAATTTCCGACTTTATTGATAAACAGCATGTAATAAAAAGGCATTTTAAAGATAGTAA
6BF TGGAATTTCCGACTTTATTGATAAACAGCATGTAATAAAAAGGCATTTTAAAGATAGTAA
6BSP TGGAATTTCCGACTTTATTGATAAACAGCATGTAATAAAAAGGCATTTTAAAGATAGTAA
19AH TGGAATTTCCGACTTTATTGATAAACAGCATGTAATAAAAAGGCATTTTAAAGATAGTAA
23FPO TGGAATTTCCGACTTTATTGATAAACAGCATGTAATAAAAAGGCATTTTAAAGATAGTAA
19FTW TGGAATTTCCGACTTTATTGATAAACAGCATGTAATAAAAAGGCATTTTAAAGATAGTAA
9VSP TGGAATTTCCGACTTTATTGATAAACAGCATGTAATAAAAAGGCATTTTAAAGATAGTAA
TIGR4 TGGAATTTCCGACTTTATTGATAAACAGCATGTAATAAAAAGGCATTTTAAAGATAGTAA
23FTW TGGAATTTCCGACTTTATTGATAAACAGCATGTAATAAAAAGGCATTTTAAAGATAGTAA

14CSR TGAGTATGGTGGAGTTTATGGCTTATTTTTTTTATTAGAAAATATTTTTTATCAAAAT
670 TGAGTATGGTGGAGTTTATGGCTTATTTTTTTTATTAGAAAATATTTTTTATCAAAAT
6BF TGAGTATGGTGGAGTTTATGGCTTATTTTTTTTATTAGAAAATATTTTTTATCAAAAT
6BSP TGAGTATGGTGGAGTTTATGGCTTATTTTTTTTATTAGAAAATATTTTTTATCAAAAT
19AH TGAGTATGGTGGAGTTTATGGCTTATTTTTTTTATTAGAAAATATTTTTTATCAAAAT
23FPO TGAGTATGGTGGAGTTTATGGCTTATTTTTTTTATTAGAAAATATTTTTTATCAAAAT
19FTW TGAGTATGGTGGAGTTTATGGCTTATTTTTTTTATTAGAAAATATTTTTTATCAAAAT
9VSP TGAGTATGGTGGAGTTTATGGCTTATTTTTTTTATTAGAAAATATTTTTTATCAAAAT
TIGR4 TGAGTATGGTGGAGTTTATGGCTTATTTTTTTTATTAGAAAATATTTTTTATCAAAAT
23FTW TGAGTATGGTGGAGTTTATGGCTTATTTTTTTTATTAGAAAATATTTTTTATCAAAAT

14CSR ATTGTCGTTCTATAAAAAAATATGTGATAAAAAATATCTATTGTGATGGAAGTTGTTTTAA
670 ATTGTCGTTCTATAAAAAAATATGTGATAAAAAATATCTATTGTGATGGAAGTTGTTTTAA
6BF ATTGTCGTTCTATAAAAAAATATGTGATAAAAAATATCTATTGTGATGGAAGTTGTTTTAA
6BSP ATTGTCGTTCTATAAAAAAATATGTGATAAAAAATATCTATTGTGATGGAAGTTGTTTTAA
19AH ATTGTCGTTCTATAAAAAAATATGTGATAAAAAATATCTATTGTGATGGAAGTTGTTTTAA
23FPO ATTGTCGTTCTATAAAAAAATATGTGATAAAAAATATCTATTGTGATGGAAGTTGTTTTAA
19FTW ATTGTCGTTCTATAAAAAAATATGTGATAAAAAATATCTATTGTGATGGAAGTTGTTTTAA
9VSP ATTGTCGTTCTATAAAAAAATATGTGATAAAAAATATCTATTGTGATGGAAGTTGTTTTAA
TIGR4 ATTGTCGTTCTATAAAAAAATATGTGATAAAAAATATCTATTGTGATGGAAGTTGTTTTAA
23FTW ATTGTCGTTCTATAAAAAAATATGTGATAAAAAATATCTATTGTGATGGAAGTTGTTTTAA

14CSR TTTATACTAGGATAGTTAATAGTAATACTATACTATACTATATTGTATACAAGTGTGTCA
670 TTTATACTAGGATAGTTAATAGTAATACTATACTATACTATACTATATTGTATACAAGTGTGTCA
6BF TTTATACTAGGATAGTTAATAGTAATACTATACTATACTATACTATATTGTATACAAGTGTGTCA
6BSP TTTATACTAGGATAGTTAATAGTAATACTATACTATACTATACTATATTGTATACAAGTGTGTCA
19AH TTTATACTAGGATAGTTAATAGTAATACTATACTATACTATACTATATTGTATACAAGTGTGTCA
23FPO TTTATACTAGGATAGTTAATAGTAATACTATACTATACTATACTATATTGTATACAAGTGTGTCA
19FTW TTTATACTAGGATAGTTAATAGTAATACTATACTATACTATACTATATTGTATACAAGTGTGTCA
9VSP TTTATACTAGGATAGTTAATAGTAATACTATACTATACTATACTATATTGTATACAAGTGTGTCA
TIGR4 TTTATACTAGGATAGTTAATAGTAATACTATACTATACTATACTATATTGTATACAAGTGTGTCA
23FTW TTTATACTAGGATAGTTAATAGTAATACTATACTATACTATACTA----TATTGTATACAAGTGTGTCA

Figure 196G

PCT/US05/27239

400/487

14CSR TTGCCAGGTTGAGAAGATAGCTATAACGCACCTTTTATACGCTTTTGTCTACGTTTGTAGT
670 TTGCCAGGTTGAGAAGATAGCTATAACGCACCTTTTATACGCTTTTGTCTACGTTTGTAGT
6BF TTGCCAGGTTGAGAAGATAGCTATAACGCACCTTTTATACGCTTTTGTCTACGTTTGTAGT
6BSP TTGCCAGGTTGAGAAGATAGCTATAACGCACCTTTTATACGCTTTTGTCTACGTTTGTAGT
19AH TTGCCAGGTTGAGAAGATAGCTATAACGCACCTTTTATACGCTTTTGTCTACGTTTGTAGT
23FPO TTGCCAGGTTGAGAAGATAGCTATAACGCACCTTTTATACGCTTTTGTCTACGTTTGTAGT
19FTW TTGCCAGGTTGAGAAGATAGCTATAACGCACCTTTTATACGCTTTTGTCTACGTTTGTAGT
9VSP TTGCCAGGTTGAGAAGATAGCTATAACGCACCTTTTATACGCTTTTGTCTACGTTTGTAGT
TIGR4 TTGCCAGGTTGAGAAGATAGCTATAACGCACCTTTTATACGCTTTTGTCTACGTTTGTAGT
23FTW TTGCCAGGTTGAGAAGATAGCTATAACGCACCTTTTATACGCTTTTGTCTACGTTTGTAGT

14CSR GAACGGATTAACCTCAG--TGAGATAAATTTTATCAGAACATAAGTAATCCGTTTCTTCGT
670 GAACGGATTAACCTCAG--TGAGATAAATTTTATCAGAACATAAGTAATCCGTTTCTTCGT
6BF GAACGGATTAACCTCAG--TGAGATAAATTTTATCAGAACATAAGTAATCCGTTTCTTCGT
6BSP GAACGGATTAACCTCAG--TGAGATAAATTTTATCAGAACATAAGTAATCCGTTTCTTCGT
19AH GAACGGATTAACCTCAGCATGAGATAAATTTTATCAGAA--TAAGTAATCCGTTTCTTCGT
23FPO GAACGGATTAACCTCAGCATGAGATAAATTTTATCAGAA--TAAGTAATCCGTTTCTTCGT
19FTW GAACGGATTAACCTCAG--TGAGATAAATTTTATCAGAACATAAGTAATCCGTTTCTTCGT
9VSP GAACGGATTAACCTCAG--TGAGATAAATTTTATCAGAACATAAGTAATCCGTTTCTTCGT
TIGR4 GAACGGATTAACCTCAG--TGAGATAAATTTTATCAGAACATAAGTAATCCGTTTCTTCGT
23FTW GAACGGATTAACCTCAG--TGAGATAAATTTTATCAGAACATAAGTAATCCGTTTCTTCGT

14CSR GTATACAGATTGAAAGTACCTATGAATCATAGAAGGATTAACCTTGTCTATGAATAATGC
670 GTATACAGATTGAAAGTACCTATGAATCATAGAAGGATTAACCTTGTCTATGAATAATGC
6BF GTATACAGATTGAAAGTACCTATGAATCATAGAAGGATTAACCTTGTCTATGAATAATGC
6BSP GTATACAGATTGAAAGTACCTATGAATCATAGAAGGATTAACCTTGTCTATGAATAATGC
19AH GTATACAGATTGAAAGTACCTATGAATCATAGAAGGATTAACCTTGTCTATGAATAATGC
23FPO GTATACAGATTGAAAGTACCTATGAATCATAGAAGGATTAACCTTGTCTATGAATAATGC
19FTW GTATACAGATTGAAAGTACCTATGAATCATAGAAGGATTAACCTTGTCTATGAATAATGC
9VSP GTATACAGATTGAAAGTACCTATGAATCATAGAAGGATTAACCTTGTCTATGAATAATGC
TIGR4 GTATACAGATTGAAAGTACCTATGAATCATAGAAGGATTAACCTTGTCTATGAATAATGC
23FTW GTATACAGATTGAAAGTACCTATGAATCATAGAAGGATTAACCTTGTCTATGAATAATGC

14CSR TTAACAGGGAGACACACATGAAAAAAGTAAGAAAGATATTTT CAGAAGGCAGTTGCAGGAC
670 TTAACAGGGAGACACACATGAAAAAAGTAAGAAAGATATTTT CAGAAGGCAGTTGCAGGAC
6BF TTAACAGGGAGACACACATGAAAAAAGTAAGAAAGATATTTT CAGAAGGCAGTTGCAGGAC
6BSP TTAACAGGGAGACACACATGAAAAAAGTAAGAAAGATATTTT CAGAAGGCAGTTGCAGGAC
19AH TTAACAGGGAGACACACATGAAAAAAGTAAGAAAGATATTTT CAGAAGGCAGTTGCAGGAC
23FPO TTAACAGGGAGACACACATGAAAAAAGTAAGAAAGATATTTT CAGAAGGCAGTTGCAGGAC
19FTW TTAACAGGGAGACACACATGAAAAAAGTAAGAAAGATATTTT CAGAAGGCAGTTGCAGGAC
9VSP TTAACAGGGAGACACACATGAAAAAAGTAAGAAAGATATTTT CAGAAGGCAGTTGCAGGAC
TIGR4 TTAACAGGGAGACACACATGAAAAAAGTAAGAAAGATATTTT CAGAAGGCAGTTGCAGGAC
23FTW TTAACAGGGAGACACACATGAAAAAAGTAAGAAAGATATTTT CAGAAGGCAGTTGCAGGAC

14CSR TGTGCTGTATATCTCAGTTGACAGCTTTTTCTTCGATAGTTGCTTTAGCAGAAACGCCTG
670 TGTGCTGTATATCTCAGTTGACAGCTTTTTCTTCGATAGTTGCTTTAGCAGAAACGCCTG
6BF TGTGCTGTATATCTCAGTTGACAGCTTTTTCTTCGATAGTTGCTTTAGCAGAAACGCCTG
6BSP TGTGCTGTATATCTCAGTTGACAGCTTTTTCTTCGATAGTTGCTTTAGCAGAAACGCCTG
19AH TGTGCTGTATATCTCAGTTGACAGCTTTTTCTTCGATAGTTGCTTTAGCAGAAACGCCTG
23FPO TGTGCTGTATATCTCAGTTGACAGCTTTTTCTTCGATAGTTGCTTTAGCAGAAACGCCTG
19FTW TGTGCTGTATATCTCAGTTGACAGCTTTTTCTTCGATAGTTGCTTTAGCAGAAACGCCTG
9VSP TGTGCTGTATATCTCAGTTGACAGCTTTTTCTTCGATAGTTGCTTTAGCAGAAACGCCTG
TIGR4 TGTGCTGTATATCTCAGTTGACAGCTTTTTCTTCGATAGTTGCTTTAGCAGAAACGCCTG
23FTW TGTGCTGTATATCTCAGTTGACAGCTTTTTCTTCGATAGTTGCTTTAGCAGAAACGCCTG

Figure 196H

PCT/US05/27239

14CSR AAACCAGTCCAGCGATAGGAAAAGTAGTGATTAAGGAGACAGGCCGAAGGAGGAGCGCTTC
670 AAACCAGTCCAGCGATAGGAAAAGTAGTGATTAAGGAGACAGGCCGAAGGAGGAGCGCTTC
6BF AAACCAGTCCAGCGATAGGAAAAGTAGTGATTAAGGAGACAGGCCGAAGGAGGAGCGCTTC
6BSP AAACCAGTCCAGCGATAGGAAAAGTAGTGATTAAGGAGACAGGCCGAAGGAGGAGCGCTTC
19AH AAACCAGTCCAGCGATAGGAAAAGTAGTGATTAAGGAGACAGGCCGAAGGAGGAGCGCTTC
23FPO AAACCAGTCCAGCGATAGGAAAAGTAGTGATTAAGGAGACAGGCCGAAGGAGGAGCGCTTC
19FTW AAACCAGTCCAGCGATAGGAAAAGTAGTGATTAAGGAGACAGGCCGAAGGAGGAGCGCTTC
9VSP AAACCAGTCCAGCGATAGGAAAAGTAGTGATTAAGGAGACAGGCCGAAGGAGGAGCGCTTC
TIGR4 AAACCAGTCCAGCGATAGGAAAAGTAGTGATTAAGGAGACAGGCCGAAGGAGGAGCGCTTC
23FTW AAACCAGTCCAGCGATAGGAAAAGTAGTGATTAAGGAGACAGGCCGAAGGAGGAGCGCTTC

14CSR TAGGAGATGCCGTCTTTGAGTTGAAAAACAATACGGATGGCACAACCTGTTTCGCAAAGGA
670 TAGGAGATGCCGTCTTTGAGTTGAAAAACAATACGGATGGCACAACCTGTTTCGCAAAGGA
6BF TAGGAGATGCCGTCTTTGAGTTGAAAAACAATACGGATGGCACAACCTGTTTCGCAAAGGA
6BSP TAGGAGATGCCGTCTTTGAGTTGAAAAACAATACGGATGGCACAACCTGTTTCGCAAAGGA
19AH TAGGAGATGCCGTCTTTGAGTTGAAAAACAATACGGATGGCACAACCTGTTTCGCAAAGGA
23FPO TAGGAGATGCCGTCTTTGAGTTGAAAAACAATACGGATGGCACAACCTGTTTCGCAAAGGA
19FTW TAGGAGATGCCGTCTTTGAGTTGAAAAACAATACGGATGGCACAACCTGTTTCGCAAAGGA
9VSP TAGGAGATGCCGTCTTTGAGTTGAAAAACAATACGGATGGCACAACCTGTTTCGCAAAGGA
TIGR4 TAGGAGATGCCGTCTTTGAGTTGAAAAACAATACGGATGGCACAACCTGTTTCGCAAAGGA
23FTW TAGGAGATGCCGTCTTTGAGTTGAAAAACAATACGGATGGCACAACCTGTTTCGCAAAGGA

14CSR CAGAGGCGCAAAACAGGAGAAGCGATATTTCAAACATAAAAACCTGGGACATACACCTTGA
670 CAGAGGCGCAAAACAGGAGAAGCGATATTTCAAACATAAAAACCTGGGACATACACCTTGA
6BF CAGAGGCGCAAAACAGGAGAAGCGATATTTCAAACATAAAAACCTGGGACATACACCTTGA
6BSP CAGAGGCGCAAAACAGGAGAAGCGATATTTCAAACATAAAAACCTGGGACATACACCTTGA
19AH CAGAGGCGCAAAACAGGAGAAGCGATATTTCAAACATAAAAACCTGGGACATACACCTTGA
23FPO CAGAGGCGCAAAACAGGAGAAGCGATATTTCAAACATAAAAACCTGGGACATACACCTTGA
19FTW CAGAGGCGCAAAACAGGAGAAGCGATATTTCAAACATAAAAACCTGGGACATACACCTTGA
9VSP CAGAGGCGCAAAACAGGAGAAGCGATATTTCAAACATAAAAACCTGGGACATACACCTTGA
TIGR4 CAGAGGCGCAAAACAGGAGAAGCGATATTTCAAACATAAAAACCTGGGACATACACCTTGA
23FTW CAGAGGCGCAAAACAGGAGAAGCGATATTTCAAACATAAAAACCTGGGACATACACCTTGA

14CSR CAGAAGCCCAACCTCCAGTTGGTTATAAACCCCTCTACTAAACAATGGACTGTTGAAGTTG
670 CAGAAGCCCAACCTCCAGTTGGTTATAAACCCCTCTACTAAACAATGGACTGTTGAAGTTG
6BF CAGAAGCCCAACCTCCAGTTGGTTATAAACCCCTCTACTAAACAATGGACTGTTGAAGTTG
6BSP CAGAAGCCCAACCTCCAGTTGGTTATAAACCCCTCTACTAAACAATGGACTGTTGAAGTTG
19AH CAGAAGCCCAACCTCCAGTTGGTTATAAACCCCTCTACTAAACAATGGACTGTTGAAGTTG
23FPO CAGAAGCCCAACCTCCAGTTGGTTATAAACCCCTCTACTAAACAATGGACTGTTGAAGTTG
19FTW CAGAAGCCCAACCTCCAGTTGGTTATAAACCCCTCTACTAAACAATGGACTGTTGAAGTTG
9VSP CAGAAGCCCAACCTCCAGTTGGTTATAAACCCCTCTACTAAACAATGGACTGTTGAAGTTG
TIGR4 CAGAAGCCCAACCTCCAGTTGGTTATAAACCCCTCTACTAAACAATGGACTGTTGAAGTTG
23FTW CAGAAGCCCAACCTCCAGTTGGTTATAAACCCCTCTACTAAACAATGGACTGTTGAAGTTG

14CSR AGAAGAATGGTCCGACGACTGTCCAAGGTGAACAGGTAGAAAATCGAGAAGAGGCTCTAT
670 AGAAGAATGGTCCGACGACTGTCCAAGGTGAACAGGTAGAAAATCGAGAAGAGGCTCTAT
6BF AGAAGAATGGTCCGACGACTGTCCAAGGTGAACAGGTAGAAAATCGAGAAGAGGCTCTAT
6BSP AGAAGAATGGTCCGACGACTGTCCAAGGTGAACAGGTAGAAAATCGAGAAGAGGCTCTAT
19AH AGAAGAATGGTCCGACGACTGTCCAAGGTGAACAGGTAGAAAATCGAGAAGAGGCTCTAT
23FPO AGAAGAATGGTCCGACGACTGTCCAAGGTGAACAGGTAGAAAATCGAGAAGAGGCTCTAT
19FTW AGAAGAATGGTCCGACGACTGTCCAAGGTGAACAGGTAGAAAATCGAGAAGAGGCTCTAT
9VSP AGAAGAATGGTCCGACGACTGTCCAAGGTGAACAGGTAGAAAATCGAGAAGAGGCTCTAT
TIGR4 AGAAGAATGGTCCGACGACTGTCCAAGGTGAACAGGTAGAAAATCGAGAAGAGGCTCTAT
23FTW AGAAGAATGGTCCGACGACTGTCCAAGGTGAACAGGTAGAAAATCGAGAAGAGGCTCTAT

Figure 196I

14CSR CTGACCAGTATCCACAAACAGGGACTTATCCAGATGTTCAAACACCTTATCAGATTATTA
670 CTGACCAGTATCCACAAACAGGGACTTATCCAGATGTTCAAACACCTTATCAGATTATTA
6BF CTGACCAGTATCCACAAACAGGGACTTATCCAGATGTTCAAACACCTTATCAGATTATTA
6BSP CTGACCAGTATCCACAAACAGGGACTTATCCAGATGTTCAAACACCTTATCAGATTATTA
19AH CTGACCAGTATCCACAAACAGGGACTTATCCAGATGTTCAAACACCTTATCAGATTATTA
23FPO CTGACCAGTATCCACAAACAGGGACTTATCCAGATGTTCAAACACCTTATCAGATTATTA
19FTW CTGACCAGTATCCACAAACAGGGACTTATCCAGATGTTCAAACACCTTATCAGATTATTA
9VSP CTGACCAGTATCCACAAACAGGGACTTATCCAGATGTTCAAACACCTTATCAGATTATTA
TIGR4 CTGACCAGTATCCACAAACAGGGACTTATCCAGATGTTCAAACACCTTATCAGATTATTA
23FTW CTGACCAGTATCCACAAACAGGGACTTATCCAGATGTTCAAACACCTTATCAGATTATTA

14CSR AGGTAGATGGTTCGGAAAAAACGGACAGCACAAGGCGTTGAATCCGAATCCATATGAAC
670 AGGTAGATGGTTCGGAAAAAACGGACAGCACAAGGCGTTGAATCCGAATCCATATGAAC
6BF AGGTAGATGGTTCGGAAAAAACGGACAGCACAAGGCGTTGAATCCGAATCCATATGAAC
6BSP AGGTAGATGGTTCGGAAAAAACGGACAGCACAAGGCGTTGAATCCGAATCCATATGAAC
19AH AGGTAGATGGTTCGGAAAAAACGGACAGCACAAGGCGTTGAATCCGAATCCATATGAAC
23FPO AGGTAGATGGTTCGGAAAAAACGGACAGCACAAGGCGTTGAATCCGAATCCATATGAAC
19FTW AGGTAGATGGTTCGGAAAAAACGGACAGCACAAGGCGTTGAATCCGAATCCATATGAAC
9VSP AGGTAGATGGTTCGGAAAAAACGGACAGCACAAGGCGTTGAATCCGAATCCATATGAAC
TIGR4 AGGTAGATGGTTCGGAAAAAACGGACAGCACAAGGCGTTGAATCCGAATCCATATGAAC
23FTW AGGTAGATGGTTCGGAAAAAACGGACAGCACAAGGCGTTGAATCCGAATCCATATGAAC

14CSR GTGTGATTCCAGAAGGTACACTTTCAAAGAGAATTTATCAAGTGAATAATTTGGATGATA
670 GTGTGATTCCAGAAGGTACACTTTCAAAGAGAATTTATCAAGTGAATAATTTGGATGATA
6BF GTGTGATTCCAGAAGGTACACTTTCAAAGAGAATTTATCAAGTGAATAATTTGGATGATA
6BSP GTGTGATTCCAGAAGGTACACTTTCAAAGAGAATTTATCAAGTGAATAATTTGGATGATA
19AH GTGTGATTCCAGAAGGTACACTTTCAAAGAGAATTTATCAAGTGAATAATTTGGATGATA
23FPO GTGTGATTCCAGAAGGTACACTTTCAAAGAGAATTTATCAAGTGAATAATTTGGATGATA
19FTW GTGTGATTCCAGAAGGTACACTTTCAAAGAGAATTTATCAAGTGAATAATTTGGATGATA
9VSP GTGTGATTCCAGAAGGTACACTTTCAAAGAGAATTTATCAAGTGAATAATTTGGATGATA
TIGR4 GTGTGATTCCAGAAGGTACACTTTCAAAGAGAATTTATCAAGTGAATAATTTGGATGATA
23FTW GTGTGATTCCAGAAGGTACACTTTCAAAGAGAATTTATCAAGTGAATAATTTGGATGATA

14CSR ACCAATATGGAATCGAGTTGACGGTTAGTGGTAAAACGACGGTTGAAACGAAAGAAGCCT
670 ACCAATATGGAATCGAGTTGACGGTTAGTGGTAAAACGACGGTTGAAACGAAAGAAGCCT
6BF ACCAATATGGAATCGAGTTGACGGTTAGTGGTAAAACGACGGTTGAAACGAAAGAAGCCT
6BSP ACCAATATGGAATCGAGTTGACGGTTAGTGGTAAAACGACGGTTGAAACGAAAGAAGCCT
19AH ACCAATATGGAATCGAGTTGACGGTTAGTGGTAAAACGACGGTTGAAACGAAAGAAGCCT
23FPO ACCAATATGGAATCGAGTTGACGGTTAGTGGTAAAACGACGGTTGAAACGAAAGAAGCCT
19FTW ACCAATATGGAATCGAATTGACGGTTAGTGGGAAAACAGTGTATGAACGAAAAGATAAGT
9VSP ACCAATATGGAATCGAATTGACGGTTAGTGGGAAAACAGTGTATGAACGAAAAGATAAGT
TIGR4 ACCAATATGGAATCGAATTGACGGTTAGTGGGAAAACAGTGTATGAACGAAAAGATAAGT
23FTW ACCAATATGGAATCGAATTGACGGTTAGTGGGAAAACAGTGTATGAACGAAAAGATAAGT
***** * * * * *

14CSR CTACTCCGCTAGATGTTGTTATTCTATTAGATAAECTCCAATAGTATGAGTAATATTCGAC
670 CTACTCCGCTAGATGTTGTTATTCTATTAGATAAECTCCAATAGTATGAGTAATATTCGAC
6BF CTACTCCGCTAGATGTTGTTATTCTATTAGATAAECTCCAATAGTATGAGTAATATTCGAC
6BSP CTACTCCGCTAGATGTTGTTATTCTATTAGATAAECTCCAATAGTATGAGTAATATTCGAC
19AH CTACTCCGCTAGATGTTGTTATTCTATTAGATAAECTCCAATAGTATGAGTAATATTCGAC
23FPO CTACTCCGCTAGATGTTGTTATTCTATTAGATAAECTCCAATAGTATGAGTAATATTCGAC
19FTW CTGTGCCGCTGGATGTCGTTATCTTGCTCGATAAECTCAAATAGTATGAGTAACATTCGAA
9VSP CTGTGCCGCTGGATGTCGTTATCTTGCTCGATAAECTCAAATAGTATGAGTAACATTCGAA
TIGR4 CTGTGCCGCTGGATGTCGTTATCTTGCTCGATAAECTCAAATAGTATGAGTAACATTCGAA
23FTW CTGTGCCGCTGGATGTCGTTATCTTGCTCGATAAECTCAAATAGTATGAGTAACATTCGAA
** * * * * *

Figure 196J

PCT/US05/27239

14CSR ATAATCATGCCCATCGAGCGGAAAAAGCGGGAGAAGCGACACGAGCCCTTGTAGATAAGA
670 ATAATCATGCCCATCGAGCGGAAAAAGCGGGAGAAGCGACACGAGCCCTTGTAGATAAGA
6BF ATAATCATGCCCATCGAGCGGAAAAAGCGGGAGAAGCGACACGAGCCCTTGTAGATAAGA
6BSP ATAATCATGCCCATCGAGCGGAAAAAGCGGGAGAAGCGACACGAGCCCTTGTAGATAAGA
19AH ATAATCATGCCCATCGAGCGGAAAAAGCGGGAGAAGCGACACGAGCCCTTGTAGATAAGA
23FPO ATAATCATGCCCATCGAGCGGAAAAAGCGGGAGAAGCGACACGAGCCCTTGTAGATAAGA
19FTW ACAAGAATGCTCGACGTGCGGAAAGAGCTGGTGAGGCGACACGTTCTCTTATTGATAAAA
9VSP ACAAGAATGCTCGACGTGCGGAAAGAGCTGGTGAGGCGACACGTTCTCTTATTGATAAAA
TIGR4 ACAAGAATGCTCGACGTGCGGAAAGAGCTGGTGAGGCGACACGTTCTCTTATTGATAAAA
23FTW ACAAGAATGCTCGACGTGCGGAAAGAGCTGGTGAGGCGACACGTTCTCTTATTGATAAAA
* * * **** * * * ***** * * * * * ***** * * * * * ***** *

14CSR TTACCTCCAATCCAGATAATCGAGTAGCACTTGTGACTTATGGCTCAACTATCTTTGACG
670 TTACCTCCAATCCAGATAATCGAGTAGCACTTGTGACTTATGGCTCAACTATCTTTGACG
6BF TTACCTCCAATCCAGATAATCGAGTAGCACTTGTGACTTATGGCTCAACTATCTTTGACG
6BSP TTACCTCCAATCCAGATAATCGAGTAGCACTTGTGACTTATGGCTCAACTATCTTTGACG
19AH TTACCTCCAATCCAGATAATCGAGTAGCACTTGTGACTTATGGCTCAACTATCTTTGACG
23FPO TTACCTCCAATCCAGATAATCGAGTAGCACTTGTGACTTATGGCTCAACTATCTTTGACG
19FTW TTACATCTGATCCAGAAAATAGGGTAGCGCTTGTGACTTATGCTCCACTATCTTTGATG
9VSP TTACATCTGATCCAGAAAATAGGGTAGCGCTTGTGACTTATGCTCCACTATCTTTGATG
TIGR4 TTACATCTGATCCAGAAAATAGGGTAGCGCTTGTGACTTATGCTCCACTATCTTTGATG
23FTW TTACATCTGATCCAGAAAATAGGGTAGCGCTTGTGACTTATGCTCCACTATCTTTGATG
**** * * * * **** * * * * * ***** ***** * * ***** * * *

14CSR GTTTCCAGAAAGCTACTGTGGAAAAAGGGGTAGCAGATGCGAACGGAAAAATATTGAATGACT
670 GTTTCCAGAAAGCTACTGTGGAAAAAGGGGTAGCAGATGCGAACGGAAAAATATTGAATGACT
6BF GTTTCCAGAAAGCTACTGTGGAAAAAGGGGTAGCAGATGCGAACGGAAAAATATTGAATGACT
6BSP GTTTCCAGAAAGCTACTGTGGAAAAAGGGGTAGCAGATGCGAACGGAAAAATATTGAATGACT
19AH GTTTCCAGAAAGCTACTGTGGAAAAAGGGGTAGCAGATGCGAACGGAAAAATATTGAATGACT
23FPO GTTTCCAGAAAGCTACTGTGGAAAAAGGGGTAGCAGATGCGAACGGAAAAATATTGAATGACT
19FTW GGACCCGAGTTTACAGTAGAAAAAGGGGTAGCAGATAAAAAACGGAAAACGATTGAATGATT
9VSP GGACCCGAGTTTACAGTAGAAAAAGGGGTAGCAGATAAAAAACGGAAAACGATTGAATGATT
TIGR4 GGACCCGAGTTTACAGTAGAAAAAGGGGTAGCAGATAAAAAACGGAAAACGATTGAATGATT
23FTW GGACCCGAGTTTACAGTAGAAAAAGGGGTAGCAGATAAAAAACGGAAAACGATTGAATGATT
* * * * *** * * ***** ***** ***** * * ***** * *

14CSR CAGCTTTATGGACGTTTCGATCGTACGACGTTTACAGCTAAAACCTATAAATTATAGCTTTT
670 CAGCTTTATGGACGTTTCGATCGTACGACGTTTACAGCTAAAACCTATAAATTATAGCTTTT
6BF CAGCTTTATGGACGTTTCGATCGTACGACGTTTACAGCTAAAACCTATAAATTATAGCTTTT
6BSP CAGCTTTATGGACGTTTCGATCGTACGACGTTTACAGCTAAAACCTATAAATTATAGCTTTT
19AH CAGCTTTATGGACGTTTCGATCGTACGACGTTTACAGCTAAAACCTATAAATTATAGCTTTT
23FPO CAGCTTTATGGACGTTTCGATCGTACGACGTTTACAGCTAAAACCTATAAATTATAGCTTTT
19FTW CTCTTTTTTGGAAATTATGATCAGACGAGTTTACAAACCAATACCAAAGATTATAGTTATT
9VSP CTCTTTTTTGGAAATTATGATCAGACGAGTTTACAAACCAATACCAAAGATTATAGTTATT
TIGR4 CTCTTTTTTGGAAATTATGATCAGACGAGTTTACAAACCAATACCAAAGATTATAGTTATT
23FTW CTCTTTTTTGGAAATTATGATCAGACGAGTTTACAAACCAATACCAAAGATTATAGTTATT
* * * * *** * * ***** ***** ***** * * * * * ***** * *

14CSR TAAATCTCACATCAGATCCTACTGATATTCAAACCTATTAAGGATAGGATCCATCAGATG
670 TAAATCTCACATCAGATCCTACTGATATTCAAACCTATTAAGGATAGGATCCATCAGATG
6BF TAAATCTCACATCAGATCCTACTGATATTCAAACCTATTAAGGATAGGATCCATCAGATG
6BSP TAAATCTCACATCAGATCCTACTGATATTCAAACCTATTAAGGATAGGATCCATCAGATG
19AH TAAATCTCACATCAGATCCTACTGATATTCAAACCTATTAAGGATAGGATCCATCAGATG
23FPO TAAATCTCACATCAGATCCTACTGATATTCAAACCTATTAAGGATAGGATCCATCAGATG
19FTW TAAAGCTGACTAATGATAAGAATGACATTGTAGAATTAATAAATAAAGGTACCTACCGAGG
9VSP TAAAGCTGACTAATGATAAGAATGACATTGTAGAATTAATAAATAAAGGTACCTACCGAGG
TIGR4 TAAAGCTGACTAATGATAAGAATGACATTGTAGAATTAATAAATAAAGGTACCTACCGAGG
23FTW TAAAGCTGACTAATGATAAGAATGACATTGTAGAATTAATAAATAAAGGTACCTACCGAGG
**** * * * * *** *

Figure 196K

PCT/US05/27239 404/487

14CSR CAGAGGAATTGAACAAAGACAAATTGATGTATCAATTGCGCGCGACTTTTACCCAGAAGG
670 CAGAGGAATTGAACAAAGACAAATTGATGTATCAATTGCGCGCGACTTTTACCCAGAAGG
6BF CAGAGGAATTGAACAAAGACAAATTGATGTATCAATTGCGCGCGACTTTTACCCAGAAGG
6BSP CAGAGGAATTGAACAAAGACAAATTGATGTATCAATTGCGCGCGACTTTTACCCAGAAGG
19AH CAGAGGAATTGAACAAAGACAAATTGATGTATCAATTGCGCGCGACTTTTACCCAGAAGG
23FPO CAGAGGAATTGAACAAAGACAAATTGATGTATCAATTGCGCGCGACTTTTACCCAGAAGG
19FTW CAGAAGACCATGATGGAATAGATTGATGTACCAATTGCGTGCCACTTTTACTCAGAAAG
9VSP CAGAAGACCATGATGGAATAGATTGATGTACCAATTGCGTGCCACTTTTACTCAGAAAG
TIGR4 CAGAAGACCATGATGGAATAGATTGATGTACCAATTGCGTGCCACTTTTACTCAGAAAG
23FTW CAGAAGACCATGATGGAATAGATTGATGTACCAATTGCGTGCCACTTTTACTCAGAAAG
**** * * * * *

14CSR CTTTGATGACCGCTGATGATATCTTGACAAAGCAGGCAAGACCAAACAGTAAAAAGGTTA
670 CTTTGATGACCGCTGATGATATCTTGACAAAGCAGGCAAGACCAAACAGTAAAAAGGTTA
6BF CTTTGATGACCGCTGATGATATCTTGACAAAGCAGGCAAGACCAAACAGTAAAAAGGTTA
6BSP CTTTGATGACCGCTGATGATATCTTGACAAAGCAGGCAAGACCAAACAGTAAAAAGGTTA
19AH CTTTGATGACCGCTGATGATATCTTGACAAAGCAGGCAAGACCAAACAGTAAAAAGGTTA
23FPO CTTTGATGACCGCTGATGATATCTTGACAAAGCAGGCAAGACCAAACAGTAAAAAGGTTA
19FTW CTTTGATGAAGGCAGATGAGATTTTGACACAACAAGCGAGACAAAATAGTCAAAAAGTCA
9VSP CTTTGATGAAGGCAGATGAGATTTTGACACAACAAGCGAGACAAAATAGTCAAAAAGTCA
TIGR4 CTTTGATGAAGGCAGATGAGATTTTGACACAACAAGCGAGACAAAATAGTCAAAAAGTCA
23FTW CTTTGATGAAGGCAGATGAGATTTTGACACAACAAGCGAGACAAAATAGTCAAAAAGTCA
***** * * * * *

14CSR TTTTCCACATTACAGATGGTGTCCGACTATGTCATATCCAAATTAATTTAAATATACAG
670 TTTTCCACATTACAGATGGTGTCCGACTATGTCATATCCAAATTAATTTAAATATACAG
6BF TTTTCCACATTACAGATGGTGTCCGACTATGTCATATCCAAATTAATTTAAATATACAG
6BSP TTTTCCACATTACAGATGGTGTCCGACTATGTCATATCCAAATTAATTTAAATATACAG
19AH TTTTCCACATTACAGATGGTGTCCGACTATGTCATATCCAAATTAATTTAAATATACAG
23FPO TTTTCCACATTACAGATGGTGTCCGACTATGTCATATCCAAATTAATTTAAATATACAG
19FTW TTTTCCATATTACGGATGGTGTCCCAACTATGTCGATCCGATTAATTTAATCATGCTA
9VSP TTTTCCATATTACGGATGGTGTCCCAACTATGTCGATCCGATTAATTTAATCATGCTA
TIGR4 TTTTCCATATTACGGATGGTGTCCCAACTATGTCGATCCGATTAATTTAATCATGCTA
23FTW TTTTCCATATTACGGATGGTGTCCCAACTATGTCGATCCGATTAATTTAATCATGCTA
***** * * * * *

14CSR GAACGACGCAATCGTACAGAACTCAGCTGAATA-ATTTTAAAGCAAAAACCTCCAAATAGT
670 GAACGACGCAATCGTACAGAACTCAGCTGAATA-ATTTTAAAGCAAAAACCTCCAAATAGT
6BF GAACGACGCAATCGTACAGAACTCAGCTGAATA-ATTTTAAAGCAAAAACCTCCAAATAGT
6BSP GAACGACGCAATCGTACAGAACTCAGCTGAATA-ATTTTAAAGCAAAAACCTCCAAATAGT
19AH GAACGACGCAATCGTACAGAACTCAGCTGAATA-ATTTTAAAGCAAAAACCTCCAAATAGT
23FPO GAACGACGCAATCGTACAGAACTCAGCTGAATA-ATTTTAAAGCAAAAACCTCCAAATAGT
19FTW CGTTTGCTCCATCATATCAAATCAACTAAATGCATTTTTTAGTAAAT-CTCCTAATAAAA
9VSP CGTTTGCTCCATCATATCAAATCAACTAAATGCATTTTTTAGTAAAT-CTCCTAATAAAA
TIGR4 CGTTTGCTCCATCATATCAAATCAACTAAATGCATTTTTTAGTAAAT-CTCCTAATAAAA
23FTW CGTTTGCTCCATCATATCAAATCAACTAAATGCATTTTTTAGTAAAT-CTCCTAATAAAA
* * * * *

14CSR AGCGGGATATTAAGTACTGGAGGACTTTGTTACATGGTCAGCAGATGGTGAACATAAAGATTGTT
670 AGCGGGATATTAAGTACTGGAGGACTTTGTTACATGGTCAGCAGATGGTGAACATAAAGATTGTT
6BF AGCGGGATATTAAGTACTGGAGGACTTTGTTACATGGTCAGCAGATGGTGAACATAAAGATTGTT
6BSP AGCGGGATATTAAGTACTGGAGGACTTTGTTACATGGTCAGCAGATGGTGAACATAAAGATTGTT
19AH AGCGGGATATTAAGTACTGGAGGACTTTGTTACATGGTCAGCAGATGGTGAACATAAAGATTGTT
23FPO AGCGGGATATTAAGTACTGGAGGACTTTGTTACATGGTCAGCAGATGGTGAACATAAAGATTGTT
19FTW GATGGAATACTATTAAGTGATTTTTATTACGCAAGCAACTAGTGGAGAACATACAATTGTA
9VSP GATGGAATACTATTAAGTGATTTTTATTACGCAAGCAACTAGTGGAGAACATACAATTGTA
TIGR4 GATGGAATACTATTAAGTGATTTTTATTACGCAAGCAACTAGTGGAGAACATACAATTGTA
23FTW GATGGAATACTATTAAGTGATTTTTATTACGCAAGCAACTAGTGGAGAACATACAATTGTA
* * * * *

Figure 196L

PCT/US05/27239

14CSR CGTGGAGATGGTGAAAGTTATCAGATGTTTACGAAGAAACCTGT-----AACAGACCAA
670 CGTGGAGATGGTGAAAGTTATCAGATGTTTACGAAGAAACCTGT-----AACAGACCAA
6BF CGTGGAGATGGTGAAAGTTATCAGATGTTTACGAAGAAACCTGT-----AACAGACCAA
6BSP CGTGGAGATGGTGAAAGTTATCAGATGTTTACGAAGAAACCTGT-----AACAGACCAA
19AH CGTGGAGATGGTGAAAGTTATCAGATGTTTACGAAGAAACCTGT-----AACAGACCAA
23FPO CGTGGAGATGGTGAAAGTTATCAGATGTTTACGAAGAAACCTGT-----AACAGACCAA
19FTW CGCGGAGATGGGCAAAGTTACCAGATGTTTACAGATAAGACAGTTTTATGAAAAAGGTGCT
9VSP CGCGGAGATGGGCAAAGTTACCAGATGTTTACAGATAAGACAGTTTTATGAAAAAGGTGCT
TIGR4 CGCGGAGATGGGCAAAGTTACCAGATGTTTACAGATAAGACAGTTTTATGAAAAAGGTGCT
23FTW CGCGGAGATGGGCAAAGTTACCAGATGTTTACAGATAAGACAGTTTTATGAAAAAGGTGCT
** *

14CSR TACGGAGTTCATCAAAT---ACTTTCAATCACCTCCATGGAGCAGAGAGCTAAATTAGTT
670 TACGGAGTTCATCAAAT---ACTTTCAATCACCTCCATGGAGCAGAGAGCTAAATTAGTT
6BF TACGGAGTTCATCAAAT---ACTTTCAATCACCTCCATGGAGCAGAGAGCTAAATTAGTT
6BSP TACGGAGTTCATCAAAT---ACTTTCAATCACCTCCATGGAGCAGAGAGCTAAATTAGTT
19AH TACGGAGTTCATCAAAT---ACTTTCAATCACCTCCATGGAGCAGAGAGCTAAATTAGTT
23FPO TACGGAGTTCATCAAAT---ACTTTCAATCACCTCCATGGAGCAGAGAGCTAAATTAGTT
19FTW CCTGCAGCTTTCCCAGTTAAACCTGAAAAATATTCTGAAATGAAGGCGGTTGGTTATGCA
9VSP CCTGCAGCTTTCCCAGTTAAACCTGAAAAATATTCTGAAATGAAGGCGGTTGGTTATGCA
TIGR4 CCTGCAGCTTTCCCAGTTAAACCTGAAAAATATTCTGAAATGAAGGCGGTTGGTTATGCA
23FTW CCTGCAGCTTTCCCAGTTAAACCTGAAAAATATTCTGAAATGAAGGCGGTTGGTTATGCA
* *

14CSR TCAGCGGGATATAGGTTCTATGGAACCTGACTTGTATTTATATTGGCGTGATAGTATCTA
670 TCAGCGGGATATAGGTTCTATGGAACCTGACTTGTATTTATATTGGCGTGATAGTATCTA
6BF TCAGCGGGATATAGGTTCTATGGAACCTGACTTGTATTTATATTGGCGTGATAGTATCTA
6BSP TCAGCGGGATATAGGTTCTATGGAACCTGACTTGTATTTATATTGGCGTGATAGTATCTA
19AH TCAGCGGGATATAGGTTCTATGGAACCTGACTTGTATTTATATTGGCGTGATAGTATCTA
23FPO TCAGCGGGATATAGGTTCTATGGAACCTGACTTGTATTTATATTGGCGTGATAGTATCTA
19FTW GTTATAGGCGATCCAATTAATGGTGGATATATTGGCTTAATTGGAGAGAGAGTATCTG
9VSP GTTATAGGCGATCCAATTAATGGTGGATATATTGGCTTAATTGGAGAGAGAGTATCTG
TIGR4 GTTATAGGCGATCCAATTAATGGTGGATATATTGGCTTAATTGGAGAGAGAGTATCTG
23FTW GTTATAGGCGATCCAATTAATGGTGGATATATTGGCTTAATTGGAGAGAGAGTATCTG
* *

14CSR GCCTATCCATTTAACTCTAGTACCGATTGGATTACCAACCATGGTGACCCTACGACTTGG
670 GCCTATCCATTTAACTCTAGTACCGATTGGATTACCAACCATGGTGACCCTACGACTTGG
6BF GCCTATCCATTTAACTCTAGTACCGATTGGATTACCAACCATGGTGACCCTACGACTTGG
6BSP GCCTATCCATTTAACTCTAGTACCGATTGGATTACCAACCATGGTGACCCTACGACTTGG
19AH GCCTATCCATTTAACTCTAGTACCGATTGGATTACCAACCATGGTGACCCTACGACTTGG
23FPO GCCTATCCATTTAACTCTAGTACCGATTGGATTACCAACCATGGTGACCCTACGACTTGG
19FTW GCTTATCCGTTTAACTCTAATACTGCTAAAATACCAATCATGGTGCCCTACAAGATGG
9VSP GCTTATCCGTTTAACTCTAATACTGCTAAAATACCAATCATGGTGACCCTACAAGATGG
TIGR4 GCTTATCCGTTTAACTCTAATACTGCTAAAATACCAATCATGGTGACCCTACAAGATGG
23FTW GCTTATCCGTTTAACTCTAATACTGCTAAAATACCAATCATGGTGACCCTACAAGATGG
* *

14CSR TATTATAACGGAAATATGGCTCAGGATGGCTATGATGTCTTCACTGTTGGGGTTGGTGTA
670 TATTATAACGGAAATATGGCTCAGGATGGCTATGATGTCTTCACTGTTGGGGTTGGTGTA
6BF TATTATAACGGAAATATGGCTCAGGATGGCTATGATGTCTTCACTGTTGGGGTTGGTGTA
6BSP TATTATAACGGAAATATGGCTCAGGATGGCTATGATGTCTTCACTGTTGGGGTTGGTGTA
19AH TATTATAACGGAAATATGGCTCAGGATGGCTATGATGTCTTCACTGTTGGGGTTGGTGTA
23FPO TATTATAACGGAAATATGGCTCAGGATGGCTATGATGTCTTCACTGTTGGGGTTGGTGTA
19FTW TACTATAACGGGAATATTGCTCCTGATGGGTATGATGTCTTTACGGTAGGTATTGGTATT
9VSP TACTATAACGGGAATATTGCTCCTGATGGGTATGATGTCTTTACGGTAGGTATTGGTATT
TIGR4 TACTATAACGGGAATATTGCTCCTGATGGGTATGATGTCTTTACGGTAGGTATTGGTATT
23FTW TACTATAACGGGAATATTGCTCCTGATGGGTATGATGTCTTTACGGTAGGTATTGGTATT
* *

Figure 196M

14CSR AACGGGGATCCTGGTACGGATGAAGCAACGGCTACTAGATTTATGCAGAGCATCTCTAGT
670 AACGGGGATCCTGGTACGGATGAAGCAACGGCTACTAGATTTATGCAGAGCATCTCTAGT
6BF AACGGGGATCCTGGTACGGATGAAGCAACGGCTACTAGATTTATGCAGAGCATCTCTAGT
6BSP AACGGGGATCCTGGTACGGATGAAGCAACGGCTACTAGATTTATGCAGAGCATCTCTAGT
19AH AACGGGGATCCTGGTACGGATGAAGCAACGGCTACTAGATTTATGCAGAGCATCTCTAGT
23FPO AACGGGGATCCTGGTACGGATGAAGCAACGGCTACTAGATTTATGCAGAGCATCTCTAGT
19FTW AACGGAGATCCTGGTACGGATGAAGCAACGGCTACTAGTTTTATGCAAAGTATTTCTAGT
9VSP AACGGAGATCCTGGTACGGATGAAGCAACGGCTACTAGTTTTATGCAAAGTATTTCTAGT
TIGR4 AACGGAGATCCTGGTACGGATGAAGCAACGGCTACTAGTTTTATGCAAAGTATTTCTAGT
23FTW AACGGAGATCCTGGTACGGATGAAGCAACGGCTACTAGTTTTATGCAAAGTATTTCTAGT

14CSR TCTCCTGACAACACTACACTAACGTAGCAGATCCATCTCAGATTTTACAAGAATTGAATCGC
670 TCTCCTGACAACACTACACTAACGTAGCAGATCCATCTCAGATTTTACAAGAATTGAATCGC
6BF TCTCCTGACAACACTACACTAACGTAGCAGATCCATCTCAGATTTTACAAGAATTGAATCGC
6BSP TCTCCTGACAACACTACACTAACGTAGCAGATCCATCTCAGATTTTACAAGAATTGAATCGC
19AH TCTCCTGACAACACTACACTAACGTAGCAGATCCATCTCAGATTTTACAAGAATTGAATCGC
23FPO TCTCCTGACAACACTACACTAACGTAGCAGATCCATCTCAGATTTTACAAGAATTGAATCGC
19FTW AAACCTGAAAACACTATACCAATGTTACTGACACGACAAAAATATTTGGAACAGTTGAATCGT
9VSP AAACCTGAAAACACTATACCAATGTTACTGACACGACAAAAATATTTGGAACAGTTGAATCGT
TIGR4 AAACCTGAAAACACTATACCAATGTTACTGACACGACAAAAATATTTGGAACAGTTGAATCGT
23FTW AAACCTGAAAACACTATACCAATGTTACTGACACGACAAAAATATTTGGAACAGTTGAATCGT

14CSR TACTTCTATACTATCGTCAATGAGAAGAAATCTATCGAAAATGGTACGATTACAGACCCG
670 TACTTCTATACTATCGTCAATGAGAAGAAATCTATCGAAAATGGTACGATTACAGACCCG
6BF TACTTCTATACTATCGTCAATGAGAAGAAATCTATCGAAAATGGTACGATTACAGACCCG
6BSP TACTTCTATACTATCGTCAATGAGAAGAAATCTATCGAAAATGGTACGATTACAGACCCG
19AH TACTTCTATACTATCGTCAATGAGAAGAAATCTATCGAAAATGGTACGATTACAGACCCG
23FPO TACTTCTATACTATCGTCAATGAGAAGAAATCTATCGAAAATGGTACGATTACAGACCCG
19FTW TATTTCCACACCATCGTAACTGAAAAGAAATCAATTGAGAATGGTACGATTACAGATCCG
9VSP TATTTCCACACCATCGTAACTGAAAAGAAATCAATTGAGAATGGTACGATTACAGATCCG
TIGR4 TATTTCCACACCATCGTAACTGAAAAGAAATCAATTGAGAATGGTACGATTACAGATCCG
23FTW TATTTCCACACCATCGTAACTGAAAAGAAATCAATTGAGAATGGTACGATTACAGATCCG
** * * * * *

14CSR ATGGGTGAACTAATTGATTTCCAATTGGGAGCAGATGGAAGGTTTGATCCAGCGGATTAC
670 ATGGGTGAACTAATTGATTTCCAATTGGGAGCAGATGGAAGGTTTGATCCAGCGGATTAC
6BF ATGGGTGAACTAATTGATTTCCAATTGGGAGCAGATGGAAGGTTTGATCCAGCGGATTAC
6BSP ATGGGTGAACTAATTGATTTCCAATTGGGAGCAGATGGAAGGTTTGATCCAGCGGATTAC
19AH ATGGGTGAACTAATTGATTTCCAATTGGGAGCAGATGGAAGGTTTGATCCAGCGGATTAC
23FPO ATGGGTGAACTAATTGATTTCCAATTGGGAGCAGATGGAAGGTTTGATCCAGCGGATTAC
19FTW ATGGGTGAGTTAATTGATTTGCAATTGGGCACAGATGGAAGATTTGATCCAGCAGATTAC
9VSP ATGGGTGAGTTAATTGATTTGCAATTGGGCACAGATGGAAGATTTGATCCAGCAGATTAC
TIGR4 ATGGGTGAGTTAATTGATTTGCAATTGGGCACAGATGGAAGATTTGATCCAGCAGATTAC
23FTW ATGGGTGAGTTAATTGATTTGCAATTGGGCACAGATGGAAGATTTGATCCAGCAGATTAC

14CSR ACTTTAACTGCAAACGATGGTAGTTTCGTTGGTGAATAATGTCCCTACTGGGGGACCACAA
670 ACTTTAACTGCAAACGATGGTAGTTTCGTTGGTGAATAATGTCCCTACTGGGGGACCACAA
6BF ACTTTAACTGCAAACGATGGTAGTTTCGTTGGTGAATAATGTCCCTACTGGGGGACCACAA
6BSP ACTTTAACTGCAAACGATGGTAGTTTCGTTGGTGAATAATGTCCCTACTGGGGGACCACAA
19AH ACTTTAACTGCAAACGATGGTAGTTTCGTTGGTGAATAATGTCCCTACTGGGGGACCACAA
23FPO ACTTTAACTGCAAACGATGGTAGTTTCGTTGGTGAATAATGTCCCTACTGGGGGACCACAA
19FTW ACTTTAACTGCAAACGATGGTAGTTTCGTTGGTGAATAATGTCCCTACTGGGGGACCACAA
9VSP ACTTTAACTGCAAACGATGGTAGTTTCGTTGGTGAATAATGTCCCTACTGGGGGACCACAA
TIGR4 ACTTTAACTGCAAACGATGGTAGTTTCGTTGGTGAATAATGTCCCTACTGGGGGACCACAA
23FTW ACTTTAACTGCAAACGATGGTAGTTTCGTTGGTGAATAATGTCCCTACTGGGGGACCACAA

Figure 196N

14CSR AATGATGGTGGCTTGCTAAAAAATGCAAAAAGTGTCTATGATACGACTGAGAAAAGGATT
670 AATGATGGTGGCTTGCTAAAAAATGCAAAAAGTGTCTATGATACGACTGAGAAAAGGATT
6BF AATGATGGTGGCTTGCTAAAAAATGCAAAAAGTGTCTATGATACGACTGAGAAAAGGATT
6BSP AATGATGGTGGCTTGCTAAAAAATGCAAAAAGTGTCTATGATACGACTGAGAAAAGGATT
19AH AATGATGGTGGCTTGCTAAAAAATGCAAAAAGTGTCTATGATACGACTGAGAAAAGGATT
23FPO AATGATGGTGGCTTGCTAAAAAATGCAAAAAGTGTCTATGATACGACTGAGAAAAGGATT
19FTW AATGATGGTGGCTTGCTAAAAAATGCAAAAAGTGTCTATGATACGACTGAGAAAAGGATT
9VSP AATGATGGTGGCTTGCTAAAAAATGCAAAAAGTGTCTATGATACGACTGAGAAAAGGATT
TIGR4 AATGATGGTGGTTGTTAAAAAATGCAAAAAGTGTCTATGATACGACTGAGAAAAGGATT
23FTW AATGATGGTGGTTGTTAAAAAATGCAAAAAGTGTCTATGATACGACTGAGAAAAGGATT
***** **

14CSR CGTGTAACAGGTTTGACCTTGAACCGGGTGAAAAAGTTACATTGACTTATAATGTTTCGC
670 CGTGTAACAGGTTTGACCTTGAACCGGGTGAAAAAGTTACATTGACTTATAATGTTTCGC
6BF CGTGTAACAGGTTTGACCTTGAACCGGGTGAAAAAGTTACATTGACTTATAATGTTTCGC
6BSP CGTGTAACAGGTTTGACCTTGAACCGGGTGAAAAAGTTACATTGACTTATAATGTTTCGC
19AH CGTGTAACAGGTTTGACCTTGAACCGGGTGAAAAAGTTACATTGACTTATAATGTTTCGC
23FPO CGTGTAACAGGTTTGACCTTGAACCGGGTGAAAAAGTTACATTGACTTATAATGTTTCGC
19FTW CGTGTAACAGGTTTGACCTTGAACCGGGTGAAAAAGTTACATTGACTTATAATGTTTCGC
9VSP CGTGTAACAGGTTTGACCTTGAACCGGGTGAAAAAGTTACATTGACTTATAATGTTTCGC
TIGR4 CGTGTAACAGGTTTGACCTTGAACCGGGTGAAAAAGTTACATTGACTTATAATGTTTCGC
23FTW CGTGTAACAGGTTTGACCTTGAACCGGGTGAAAAAGTTACATTGACTTATAATGTTTCGC
***** **

14CSR TTGAATGACCAATTTGTAAGCAATAAATCTATGACACGAATGGTGAACAAACCCCTACAC
670 TTGAATGACCAATTTGTAAGCAATAAATCTATGACACGAATGGTGAACAAACCCCTACAC
6BF TTGAATGACCAATTTGTAAGCAATAAATCTATGACACGAATGGTGAACAAACCCCTACAC
6BSP TTGAATGACCAATTTGTAAGCAATAAATCTATGACACGAATGGTGAACAAACCCCTACAC
19AH TTGAATGACCAATTTGTAAGCAATAAATCTATGACACGAATGGTGAACAAACCCCTACAC
23FPO TTGAATGACCAATTTGTAAGCAATAAATCTATGACACGAATGGTGAACAAACCCCTACAC
19FTW TTGAATGACCAATTTGTAAGCAATAAATCTATGACACGAATGGTGAACAAACCCCTACAC
9VSP TTGAATGACCAATTTGTAAGCAATAAATCTATGACACGAATGGTGAACAAACCCCTACAC
TIGR4 TTGAATGATGAGTTTGTAAAGCAATAAATTTATGATACCAATGGTGAACAAACCCCTACAT
23FTW TTGAATGATGAGTTTGTAAAGCAATAAATTTATGATACCAATGGTGAACAAACCCCTACAT
***** * ***** **

14CSR CCTAAGGAAGTAGAAAAGAACACAGTGCAGGACTTCCCGATTCCCTAAGATTTCGTGATGTA
670 CCTAAGGAAGTAGAAAAGAACACAGTGCAGGACTTCCCGATTCCCTAAGATTTCGTGATGTA
6BF CCTAAGGAAGTAGAAAAGAACACAGTGCAGGACTTCCCGATTCCCTAAGATTTCGTGATGTA
6BSP CCTAAGGAAGTAGAAAAGAACACAGTGCAGGACTTCCCGATTCCCTAAGATTTCGTGATGTA
19AH CCTAAGGAAGTAGAAAAGAACACAGTGCAGGACTTCCCGATTCCCTAAGATTTCGTGATGTA
23FPO CCTAAGGAAGTAGAAAAGAACACAGTGCAGGACTTCCCGATTCCCTAAGATTTCGTGATGTA
19FTW CCTAAGGAAGTAGAAAAGAACACAGTGCAGGACTTCCCGATTCCCTAAGATTTCGTGATGTA
9VSP CCTAAGGAAGTAGAAAAGAACACAGTGCAGGACTTCCCGATTCCCTAAGATTTCGTGATGTA
TIGR4 CCTAAGGAAGTAGAACAGAACACAGTGCAGGACTTCCCGATTCCCTAAGATTTCGTGATGTA
23FTW CCTAAGGAAGTAGAACAGAACACAGTGCAGGACTTCCCGATTCCCTAAGATTTCGTGATGTA
***** **

14CSR CGAAAGTATCCAGAAATCACAATTCAAAAGAGAAAAAATTTGGTGAATTTAGTTTATT
670 CGAAAGTATCCAGAAATCACAATTCAAAAGAGAAAAAATTTGGTGAATTTAGTTTATT
6BF CGAAAGTATCCAGAAATCACAATTCAAAAGAGAAAAAATTTGGTGAATTTAGTTTATT
6BSP CGAAAGTATCCAGAAATCACAATTCAAAAGAGAAAAAATTTGGTGAATTTAGTTTATT
19AH CGAAAGTATCCAGAAATCACAATTCAAAAGAGAAAAAATTTGGTGAATTTAGTTTATT
23FPO CGAAAGTATCCAGAAATCACAATTCAAAAGAGAAAAAATTTGGTGAATTTAGTTTATT
19FTW CGAAATATCCAGCAATTCAGATTGCAAAAAGAGAAAAAATTTGGTGAATTTAGTTTATT
9VSP CGAAATATCCAGCAATTCAGATTGCAAAAAGAGAAAAAATTTGGTGAATTTAGTTTATT
TIGR4 CGGAAGTATCCAGAAATCACAATTCAAAAGAGAAAAAATTTGGTGAATTTAGTTTATT
23FTW CGGAAGTATCCAGAAATCACAATTCAAAAGAGAAAAAATTTGGTGAATTTAGTTTATT
** * ***** **

Figure 1960

PCT/US05/27239 408/487

14CSR AAGATCAATAAGAATGATAAAAAACCACCTGAGAGATGCGGTCTTTAGTCTTCAAAAACAA
670 AAGATCAATAAGAATGATAAAAAACCACCTGAGAGATGCGGTCTTTAGTCTTCAAAAACAA
6BF AAGATCAATAAGAATGATAAAAAACCACCTGAGAGATGCGGTCTTTAGTCTTCAAAAACAA
6BSP AAGATCAATAAGAATGATAAAAAACCACCTGAGAGATGCGGTCTTTAGTCTTCAAAAACAA
19AH AAGATCAATAAGAATGATAAAAAACCACCTGAGAGATGCGGTCTTTAGTCTTCAAAAACAA
23FPO AAGATCAATAAGAATGATAAAAAACCACCTGAGAGATGCGGTCTTTAGTCTTCAAAAACAA
19FTW AAGATCAATAAGAATGATAAAAAACCACCTGAGAGATGCGGTCTTTAGTCTTCAAAAACAA
9VSP AAGATCAATAAGAATGATAAAAAACCACCTGAGAGATGCGGTCTTTAGTCTTCAAAAACAA
TIGR4 AAGGTCATAAAAAATGATAAAAAACCACCTGAGAGATGCGGTCTTTAGTCTTCAAAAACAA
23FTW AAGGTCATAAAAAATGATAAAAAACCACCTGAGAGATGCGGTCTTTAGTCTTCAAAAACAA
*** **

14CSR CATCCGGATTATCCAGATATTTATGGAGCTATTGATCAAAAATGGCACTTATCAAAATGTG
670 CATCCGGATTATCCAGATATTTATGGAGCTATTGATCAAAAATGGCACTTATCAAAATGTG
6BF CATCCGGATTATCCAGATATTTATGGAGCTATTGATCAAAAATGGCACTTATCAAAATGTG
6BSP CATCCGGATTATCCAGATATTTATGGAGCTATTGATCAAAAATGGCACTTATCAAAATGTG
19AH CATCCGGATTATCCAGATATTTATGGAGCTATTGATCAAAAATGGCACTTATCAAAATGTG
23FPO CATCCGGATTATCCAGATATTTATGGAGCTATTGATCAAAAATGGCACTTATCAAAATGTG
19FTW CATCCGGATTATCCAGATATTTATGGAGCTATTGATCAAAAATGGCACTTATCAAAATGTG
9VSP CATCCGGATTATCCAGATATTTATGGAGCTATTGATCAAAAATGGCACTTATCAAAATGTG
TIGR4 CATCCGGATTATCCAGATATTTATGGAGCTATTGATCAAAAATGGCACTTATCAAAATGTG
23FTW CATCCGGATTATCCAGATATTTATGGAGCTATTGATCAAAAATGGCACTTATCAAAATGTG
*** **

14CSR AGAACAGGTGAAGATGGTAAGTTGACCTTTAAAAATCTGTGATGGGAAATATCGATTA
670 AGAACAGGTGAAGATGGTAAGTTGACCTTTAAAAATCTGTGATGGGAAATATCGATTA
6BF AGAACAGGTGAAGATGGTAAGTTGACCTTTAAAAATCTGTGATGGGAAATATCGATTA
6BSP AGAACAGGTGAAGATGGTAAGTTGACCTTTAAAAATCTGTGATGGGAAATATCGATTA
19AH AGAACAGGTGAAGATGGTAAGTTGACCTTTAAAAATCTGTGATGGGAAATATCGATTA
23FPO AGAACAGGTGAAGATGGTAAGTTGACCTTTAAAAATCTGTGATGGGAAATATCGATTA
19FTW AGAACAGGTGAAGATGGTAAGTTGACCTTTAAAAATCTGTGATGGGAAATATCGATTA
9VSP AGAACAGGTGAAGATGGTAAGTTGACCTTTAAAAATCTGTGATGGGAAATATCGATTA
TIGR4 AGAACAGGTGAAGATGGTAAGTTGACCTTTAAAAATCTGTGATGGGAAATATCGATTA
23FTW AGAACAGGTGAAGATGGTAAGTTGACCTTTAAAAATCTGTGATGGGAAATATCGATTA
*** **

14CSR TTTGAAAATTCTGAACCAGCTGGTTATAAACCCGTTCAAATAAGCCTATCGTTGCCTTC
670 TTTGAAAATTCTGAACCAGCTGGTTATAAACCCGTTCAAATAAGCCTATCGTTGCCTTC
6BF TTTGAAAATTCTGAACCAGCTGGTTATAAACCCGTTCAAATAAGCCTATCGTTGCCTTC
6BSP TTTGAAAATTCTGAACCAGCTGGTTATAAACCCGTTCAAATAAGCCTATCGTTGCCTTC
19AH TTTGAAAATTCTGAACCAGCTGGTTATAAACCCGTTCAAATAAGCCTATCGTTGCCTTC
23FPO TTTGAAAATTCTGAACCAGCTGGTTATAAACCCGTTCAAATAAGCCTATCGTTGCCTTC
19FTW TTTGAAAATTCTGAACCAGCTGGTTATAAACCCGTTCAAATAAGCCTATCGTTGCCTTC
9VSP TTTGAAAATTCTGAACCAGCTGGTTATAAACCCGTTCAAATAAGCCTATCGTTGCCTTC
TIGR4 TTTGAAAATTCTGAACCAGCTGGTTATAAACCCGTTCAAATAAGCCTATCGTTGCCTTC
23FTW TTTGAAAATTCTGAACCAGCTGGTTATAAACCCGTTCAAATAAGCCTATCGTTGCCTTC
*** **

14CSR CAAATAGTAAATGGAGAAGTCAGAGATGTGACTTCAATCGTTCCACAAGATATACCAGCG
670 CAAATAGTAAATGGAGAAGTCAGAGATGTGACTTCAATCGTTCCACAAGATATACCAGCG
6BF CAAATAGTAAATGGAGAAGTCAGAGATGTGACTTCAATCGTTCCACAAGATATACCAGCG
6BSP CAAATAGTAAATGGAGAAGTCAGAGATGTGACTTCAATCGTTCCACAAGATATACCAGCG
19AH CAAATAGTAAATGGAGAAGTCAGAGATGTGACTTCAATCGTTCCACAAGATATACCAGCG
23FPO CAAATAGTAAATGGAGAAGTCAGAGATGTGACTTCAATCGTTCCACAAGATATACCAGCG
19FTW CAAATAGTAAATGGAGAAGTCAGAGATGTGACTTCAATCGTTCCACAAGATATACCAGCG
9VSP CAAATAGTAAATGGAGAAGTCAGAGATGTGACTTCAATCGTTCCACAAGATATACCAGCG
TIGR4 CAAATAGTAAATGGAGAAGTCAGAGATGTGACTTCAATCGTTCCACAAGATATACCAGCG
23FTW CAAATAGTAAATGGAGAAGTCAGAGATGTGACTTCAATCGTTCCACAAGATATACCAGCG
*** **

Figure 196P

PCT/US05/27239/409/487

14CSR GGTACGAGTTTACGAATGATAAGCACTATATCACAAATGAGCCAATTCCTCCAAAAAGA
670 GGTACGAGTTTACGAATGATAAGCACTATATCACAAATGAGCCAATTCCTCCAAAAAGA
6BF GGTACGAGTTTACGAATGATAAGCACTATATCACAAATGAGCCAATTCCTCCAAAAAGA
6BSP GGTACGAGTTTACGAATGATAAGCACTATATCACAAATGAGCCAATTCCTCCAAAAAGA
19AH GGTACGAGTTTACGAATGATAAGCACTATATCACAAATGAGCCAATTCCTCCAAAAAGA
23FPO GGTACGAGTTTACGAATGATAAGCACTATATCACAAATGAGCCAATTCCTCCAAAAAGA
19FTW GGTACGAGTTTACGAATGATAAGCACTATATACCAATGAACCTATTCCTCCAAAGAGA
9VSP GGTACGAGTTTACGAATGATAAGCACTATATACCAATGAACCTATTCCTCCAAAGAGA
TIGR4 GGTACGAGTTTACGAATGATAAGCACTATATACCAATGAACCTATTCCTCCAAAGAGA
23FTW GGTACGAGTTTACGAATGATAAGCACTATATACCAATGAACCTATTCCTCCAAAGAGA
***** ** ***** ** ***** ** ***** ** ***** ** ***** **

14CSR GAATATCCTCGAACTGGTGGTATCGGAATGTTGCCATTCTATCTGATAGGTTGCATGATG
670 GAATATCCTCGAACTGGTGGTATCGGAATGTTGCCATTCTATCTGATAGGTTGCATGATG
6BF GAATATCCTCGAACTGGTGGTATCGGAATGTTGCCATTCTATCTGATAGGTTGCATGATG
6BSP GAATATCCTCGAACTGGTGGTATCGGAATGTTGCCATTCTATCTGATAGGTTGCATGATG
19AH GAATATCCTCGAACTGGTGGTATCGGAATGTTGCCATTCTATCTGATAGGTTGCATGATG
23FPO GAATATCCTCGAACTGGTGGTATCGGAATGTTGCCATTCTATCTGATAGGTTGCATGATG
19FTW GAATATCCTCGAACTGGTGGTATCGGAATGTTGCCATTCTATCTGATAGGTTGCATGATG
9VSP GAATATCCTCGAACTGGTGGTATCGGAATGTTGCCATTCTATCTGATAGGTTGCATGATG
TIGR4 GAATATCCTCGAACTGGTGGTATCGGAATGTTGCCATTCTATCTGATAGGTTGCATGATG
23FTW GAATATCCTCGAACTGGTGGTATCGGAATGTTGCCATTCTATCTGATAGGTTGCATGATG
***** ***** ***** ***** ***** ***** ***** ***** *****

14CSR ATGGGAGGAGTTCTATTATACACACGGAAACATCCGTAAGTGTAGCAATGAGAAATGAT
670 ATGGGAGGAGTTCTATTATACACACGGAAACATCCGTAAGTGTAGCAATGAGAAATGAT
6BF ATGGGAGGAGTTCTATTATACACACGGAAACATCCGTAAGTGTAGCAATGAGAAATGAT
6BSP ATGGGAGGAGTTCTATTATACACACGGAAACATCCGTAAGTGTAGCAATGAGAAATGAT
19AH ATGGGAGGAGTTCTATTATACACACGGAAACATCCGTAAGTGTAGCAATGAGAAATGAT
23FPO ATGGGAGGAGTTCTATTATACACACGGAAACATCCGTAAGTGTAGCAATGAGAAATGAT
19FTW ATGGGAGGAGTTCTATTATACACACGGAAACATCCGTAAGTGTAG-----AAATGAT
9VSP ATGGGAGGAGTTCTATTATACACACGGAAACATCCGTAAGTGTAG-----AAATGAT
TIGR4 ATGGGAGGAGTTCTATTATACACACGGAAACATCCGTAAGTGTAG-----AAATGAT
23FTW ATGGGAGGAGTTCTATTATACACACGGAAACATCCGTAAGTGTAG-----AAATGAT
***** ***** ***** ***** ***** ***** ***** ***** *****

14CSR AATATCGATACTCTGAGCGATACTTTTAAGAAGTAGCACTCAAGAAGAGATTTAAGTTTA
670 AATATCGATACTCTGAGCGATACTTTTAAGAAGTAGCACTCAAGAAGAGATTTAAGTTTA
6BF AATATCGATACTCTGAGCGATACTTTTAAGAAGTAGCACTCAAGAAGAGATTTAAGTTTA
6BSP AATATCGATACTCTGAGCGATACTTTTAAGAAGTAGCACTCAAGAAGAGATTTAAGTTTA
19AH AATATCGATACTCTGAGCGATACTTTTAAGAAGTAGCACTCAAGAAGAGATTTAAGTTTA
23FPO AATATCGATACTCTGAGCGATACTTTTAAGAAGTAGCACTCAAGAAGAGATTTAAGTTTA
19FTW AATATCTATGTTCTGAACAATACTTTTAAGAAGTAGCACTCAAGAAGAGATTTAAGTTTA
9VSP AATATCTATGTTCTGAACGATACTTTTAAGAAGTAGCACTCAAGAAGAGATTTAAGTTTA
TIGR4 AATATCTATGTTCTGAACGATACTTTTAAGAAGTAGCACTCAAGAAGAGATTTAAGTTTA
23FTW AATATCTATGTTCTGAACGATACTTTTAAGAAGTAGCACTCAAGAAGAGATTTAAGTTTA
***** ** ***** * ***** ***** ***** ***** ***** *****

14CSR CTTGGTGAAAACAGTTTCTTCGCCAAGTAAACCACCATTGAAAGGGGAGATGTTTTCGA
670 CTTGGTGAAAACAGTTTCTTCGCCAAGTAAACCACCATTGAAAGGGGAGATGTTTTCGA
6BF CTTGGTGAAAACAGTTTCTTCGCCAAGTAAACCACCATTGAAAGGGGAGATGTTTTCGA
6BSP CTTGGTGAAAACAGTTTCTTCGCCAAGTAAACCACCATTGAAAGGGGAGATGTTTTCGA
19AH CTTGGTGAAAACAGTTTCTTCGCCAAGTAAACCACCATTGAAAGGGGAGATGTTTTCGA
23FPO CTTGGTGAAAACAGTTTCTTCGCCAAGTAAACCACCATTGAAAGGGGAGATGTTTTCGA
19FTW CTTGGTGAAAACAGTTTCTTCGCCAAGTAAACCACCATTGAAAGGGGAGATGTTTTCGA
9VSP CTTGGTGAAAACAGTTTCTTCGCCAAGTAAACCACCATTGAAAGGGGAGATGTTTTCGA
TIGR4 CTTGGTGAAAACAGTTTCTTCGCCAAGTAAACCACCATTGAAAGGGGAGATGTTTTCGA
23FTW CTTGGTGAAAACCTGTTTTATTTCGT-AAGTAAACTATCATTGAAAGGGGAGATGTTTTCGA
***** * ***** ***** ***** ***** ***** ***** ***** *****

Figure 196Q

PCT/US05/27239 410/487

14CSR AAACCTGCACAGAAAAAGGATTATTATTGTCATGTGTAATTCATTACATTGCTCACAGT
670 AAACCTGCACAGAAAAAGGATTATTATTGTCATGTGTAATTCATTACATTGCTCACAGT
6BF AAACCTGCACAGAAAAAGGATTATTATTGTCATGTGTAATTCATTACATTGCTCACAGT
6BSP AAACCTGCACAGAAAAAGGATTATTATTGTCATGTGTAATTCATTACATTGCTCACAGT
19AH AAACCTGCACAGAAAAAGGATTATTATTGTCATGTGTAATTCATTACATTGCTCACAGT
23FPO AAACCTGCACAGAAAAAGGATTATTATTGTCATGTGTAATTCATTACATTGCTCACAGT
19FTW AAACCTGCACAGAAAA--GGATTATTATTGTCATGTGTAATTCATTACATTGCTCACAGT
9VSP AAACCTGCACAGAAAA--GGATTATTATTGTCATGTGTAATTCATTACATTGCTCACAGT
TIGR4 AAACCTGCACAGAAAA--GGATTATTATTGTCATGTGTAATTCATTACATTGCTCACAGT
23FTW AAACCTGCACAGAAAA--GGATTATTATTGTCATGTGTAATTCATTACATTGCTCACAGT

14CSR TGATTTTAAGAGATATGAATAAGGAGAAATCATGAAATCAATCAACAAATTTTTAACAAAT
670 TGATTTTAAGAGATATGAATAAGGAGAAATCATGAAATCAATCAACAAATTTTTAACAAAT
6BF TGATTTTAAGAGATATGAATAAGGAGAAATCATGAAATCAATCAACAAATTTTTAACAAAT
6BSP TGATTTTAAGAGATATGAATAAGGAGAAATCATGAAATCAATCAACAAATTTTTAACAAAT
19AH TGATTTTAAGAGATATGAATAAGGAGAAATCATGAAATCAATCAACAAATTTTTAACAAAT
23FPO TGATTTTAAGAGATATGAATAAGGAGAAATCATGAAATCAATCAACAAATTTTTAACAAAT
19FTW TGATTTTAAGAGATA--AATAAGGAGAAATCATGAAATCAATCAACAAATTTTTAACAAAT
9VSP TGATTTTAAGAGATA--AATAAGGAGAAATCATGAAATCAATCAACAAATTTTTAACAAAT
TIGR4 TGATTTTAAGAGATATGAATAAGGAGAAATCATGAAATCAATCAACAAATTTTTAACAAAT
23FTW TGATTTTAAGAGATATGAATAAGGAGAAATCATGAAATCAATCAACAAATTTTTAACAAAT

14CSR GCTTGCTGCCTTATTACTGACAGCGAGTAGCCTGTTTTTCAGCTGCAACAGTTTTTGCGGC
670 GCTTGCTGCCTTATTACTGACAGCGAGTAGCCTGTTTTTCAGCTGCAACAGTTTTTGCGGC
6BF GCTTGCTGCCTTATTACTGACAGCGAGTAGCCTGTTTTTCAGCTGCAACAGTTTTTGCGGC
6BSP GCTTGCTGCCTTATTACTGACAGCGAGTAGCCTGTTTTTCAGCTGCAACAGTTTTTGCGGC
19AH GCTTGCTGCCTTATTACTGACAGCGAGTAGCCTGTTTTTCAGCTGCAACAGTTTTTGCGGC
23FPO GCTTGCTGCCTTATTACTGACAGCGAGTAGCCTGTTTTTCAGCTGCAACAGTTTTTGCGGC
19FTW GCTTGCTGCCTTATTATTGACAGCGAGTAGCCTGTTTTTCAGCTGCAACAGTTTTTGCGGC
9VSP GCTTGCTGCCTTATTACTGACAGCGAGTAGCCTGTTTTTCAGCTGCAACAGTTTTTGCGGC
TIGR4 GCTTGCTGCCTTATTACTGACAGCGAGTAGCCTGTTTTTCAGCTGCAACAGTTTTTGCGGC
23FTW GCTTGCTGCCTTATTACTGACAGCGAGTAGCCTGTTTTTCAGCTGCAACAGTTTTTGCGGC

14CSR GGACAATGTTAGTACAGCACCAGATGCTGTTACTAAAACCTTAAACAATCCATAAGTTACT
670 GGACAATGTTAGTACAGCACCAGATGCTGTTACTAAAACCTTAAACAATCCATAAGTTACT
6BF GGACAATGTTAGTACAGCACCAGATGCTGTTACTAAAACCTTAAACAATCCATAAGTTACT
6BSP GGACAATGTTAGTACAGCACCAGATGCTGTTACTAAAACCTTAAACAATCCATAAGTTACT
19AH GGACAATGTTAGTACAGCACCAGATGCTGTTACTAAAACCTTAAACAATCCATAAGTTACT
23FPO GGACAATGTTAGTACAGCACCAGATGCTGTTACTAAAACCTTAAACAATCCATAAGTTACT
19FTW TGG-GACGACA--ACAACATCTGTTACCGTTCATAAACTATTGGCAACAGATGGGGATAT
9VSP TGG-GACGACA--ACAACATCTGTTACCGTTCATAAACTATTGGCAACAGATGGGGATAT
TIGR4 TGG-GACGACA--ACAACATCTGTTACCGTTCATAAACTATTGGCAACAGATGGGGATAT
23FTW GGA-ACAAAA--ACTAAGACACTTACAGTTCATAAACTATTGATGACAGATCAAGAGCT
* * * * *

14CSR GCTCTCA---GAAGATGATTTAAAGACTTGGGATACAACGGTCCTAA-AGGATATGATG
670 GCTCTCA---GAAGATGATTTAAAGACTTGGGATACAACGGTCCTAA-AGGATATGATG
6BF GCTCTCA---GAAGATGATTTAAAGACTTGGGATACAACGGTCCTAA-AGGATATGATG
6BSP GCTCTCA---GAAGATGATTTAAAGACTTGGGATACAACGGTCCTAA-AGGATATGATG
19AH GCTCTCA---GAAGATGATTTAAAGACTTGGGATACAACGGTCCTAA-AGGATATGATG
23FPO GCTCTCA---GAAGATGATTTAAAGACTTGGGATACAACGGTCCTAA-AGGATATGATG
19FTW GGATAAAATTGCAAAATGAGTTAGAAACAGGTAACACTATGCTGGTAATAA-AGTGGGTGTTTC
9VSP GGATAAAATTGCAAAATGAGTTAGAAACAGGTAACACTATGCTGGTAATAA-AGTGGGTGTTTC
TIGR4 GGATAAAATTGCAAAATGAGTTAGAAACAGGTAACACTATGCTGGTAATAA-AGTGGGTGTTTC
23FTW TGAC-----GCTTGAATTCGATGCGGATTAATAAAGGTAACACTATGCTGGTAATAA-AGTGGGTGTTTC
* * * * *

Figure 196R

14CSR GAACTCAATCTAGTTTAAAAGATTTAACTGGAGTTGTAGCTG----AGGAAATTCCAAAT
670 GAACTCAATCTAGTTTAAAAGATTTAACTGGAGTTGTAGCTG----AGGAAATTCCAAAT
6BF GAACTCAATCTAGTTTAAAAGATTTAACTGGAGTTGTAGCTG----AGGAAATTCCAAAT
6BSP GAACTCAATCTAGTTTAAAAGATTTAACTGGAGTTGTAGCTG----AGGAAATTCCAAAT
19AH GAACTCAATCTAGTTTAAAAGATTTAACTGGAGTTGTAGCTG----AGGAAATTCCAAAT
23FPO GAACTCAATCTAGTTTAAAAGATTTAACTGGAGTTGTAGCTG----AGGAAATTCCAAAT
19FTW TACCTGCA---AATGCAAAGAAATTGCCGGTGTATGTTTCGTTGGACAATACTAATA
9VSP TACCTGCA---AATGCAAAGAAATTGCCGGTGTATGTTTCGTTGGACAATACTAATA
TIGR4 TACCTGCA---AATGCAAAGAAATTGCCGGTGTATGTTTCGTTGGACAATACTAATA
23FTW T-TTGAA---CAGTTCAAAACAACCTCAAGGTGTCCACAAG---GAGTAACCGAAATCT
* * * * * * * * * *

14CSR GTATACTT-----TGAATTACAAAAGTATA-ATTTGACTGATGGT--AAGGAAAAGA
670 GTATACTT-----TGAATTACAAAAGTATA-ATTTGACTGATGGT--AAGGAAAAGA
6BF GTATACTT-----TGAATTACAAAAGTATA-ATTTGACTGATGGT--AAGGAAAAGA
6BSP GTATACTT-----TGAATTACAAAAGTATA-ATTTGACTGATGGT--AAGGAAAAGA
19AH GTATACTT-----TGAATTACAAAAGTATA-ATTTGACTGATGGT--AAGGAAAAGA
23FPO GTATACTT-----TGAATTACAAAAGTATA-ATTTGACTGATGGT--AAGGAAAAGA
19FTW ATGAAATTATTGATGAAAATGGCCAACTCTAGGAGTGAATATTGATCCACAACAATTTA
9VSP ATGAAATTATTGATGAAAATGGCCAACTCTAGGAGTGAATATTGATCCACAACAATTTA
TIGR4 ATGAAATTATTGATGAAAATGGCCAACTCTAGGAGTGAATATTGATCCACAACAATTTA
23FTW CTGGTGTTCG--ATTGAGTTACAGAGTTATACGGGTCCTCAAGGA--AAAGAACAAGAA
* ** * * * * * * * * *

14CSR AAATCTTAAAGATGATAGTAAATGGACAACAGTTCATGGTGGTTTGACAACATAAGATGG
670 AAATCTTAAAGATGATAGTAAATGGACAACAGTTCATGGTGGTTTGACAACATAAGATGG
6BF AAATCTTAAAGATGATAGTAAATGGACAACAGTTCATGGTGGTTTGACAACATAAGATGG
6BSP AAATCTTAAAGATGATAGTAAATGGACAACAGTTCATGGTGGTTTGACAACATAAGATGG
19AH AAATCTTAAAGATGATAGTAAATGGACAACAGTTCATGGTGGTTTGACAACATAAGATGG
23FPO AAATCTTAAAGATGATAGTAAATGGACAACAGTTCATGGTGGTTTGACAACATAAGATGG
19FTW AACTCTCAGGGGCAATGCCGGC--AACTGCAATGAAAAATTAACAGAAGCTGAA---GG
9VSP AACTCTCAGGGGCAATGCCGGC--AACTGCAATGAAAAATTAACAGAAGCTGAA---GG
TIGR4 AACTCTCAGGGGCAATGCCGGC--AACTGCAATGAAAAATTAACAGAAGCTGAA---GG
23FTW AA-TTAAACGAATGATGCGGTTTGGACTGCGGTTAATAAAGGTGTGACGACTGAAACAGG
** * * * * * * * * *

14CSR ACTTAAAATTGAAACCAGTACTCTTAAAGGTGT---GTATCGTATTCGTGAGGATAGAAC
670 ACTTAAAATTGAAACCAGTACTCTTAAAGGTGT---GTATCGTATTCGTGAGGATAGAAC
6BF ACTTAAAATTGAAACCAGTACTCTTAAAGGTGT---GTATCGTATTCGTGAGGATAGAAC
6BSP ACTTAAAATTGAAACCAGTACTCTTAAAGGTGT---GTATCGTATTCGTGAGGATAGAAC
19AH ACTTAAAATTGAAACCAGTACTCTTAAAGGTGT---GTATCGTATTCGTGAGGATAGAAC
23FPO ACTTAAAATTGAAACCAGTACTCTTAAAGGTGT---GTATCGTATTCGTGAGGATAGAAC
19FTW AGCTAAAATTTAACACGGCAAATTTACCAGCTGCTAAGTATAAAAATTTATGAAATTCACAG
9VSP AGCTAAAATTTAACACGGCAAATTTACCAGCTGCTAAGTATAAAAATTTATGAAATTCACAG
TIGR4 AGCTAAAATTTAACACGGCAAATTTACCAGCTGCTAAGTATAAAAATTTATGAAATTCACAG
23FTW TGTAAAATTTGATGACTGAAGTTTACAAGGGAC---ATATCGTCTGTGCGAAGTACGTAA
**** * * * * * * * * *

14CSR AAAGACTACCTATGTTGGTCCTAATGGGCAAGTATTAACAGGTTCAAAGCCGTACCTGC
670 AAAGACTACCTATGTTGGTCCTAATGGGCAAGTATTAACAGGTTCAAAGCCGTACCTGC
6BF AAAGACTACCTATGTTGGTCCTAATGGGCAAGTATTAACAGGTTCAAAGCCGTACCTGC
6BSP AAAGACTACCTATGTTGGTCCTAATGGGCAAGTATTAACAGGTTCAAAGCCGTACCTGC
19AH AAAGACTACCTATGTTGGTCCTAATGGGCAAGTATTAACAGGTTCAAAGCCGTACCTGC
23FPO AAAGACTACCTATGTTGGTCCTAATGGGCAAGTATTAACAGGTTCAAAGCCGTACCTGC
19FTW TTTATCAACTTATGTCGGTGAAGATGGAGCAACCTTAACAGGTTCTAAAGCAGTTCCAAT
9VSP TTTATCAACTTATGTCGGTGAAGATGGAGCAACCTTAACAGGTTCTAAAGCAGTTCCAAT
TIGR4 TTTATCAACTTATGTCGGTGAAGATGGAGCAACCTTAACAGGTTCTAAAGCAGTTCCAAT
23FTW AGAATCGACTTATGTCGGTCAAATGGTAAAGTTTTAAAGGTTTAAAGGTTGAAAGCTGTTCCCTGC
* * * * * * * * * *

Figure 196S

PCT/US05/27239 412/487

```

14CSR      TCTTGTAACCTCTTCCACTTGTTAACAAATAATGGTACAGTAATTGATGCACATGTTTTCCC
670        TCTTGTAACCTCTTCCACTTGTTAACAAATAATGGTACAGTAATTGATGCACATGTTTTCCC
6BF        TCTTGTAACCTCTTCCACTTGTTAACAAATAATGGTACAGTAATTGATGCACATGTTTTCCC
6BSP       TCTTGTAACCTCTTCCACTTGTTAACAAATAATGGTACAGTAATTGATGCACATGTTTTCCC
19AH       TCTTGTAACCTCTTCCACTTGTTAACAAATAATGGTACAGTAATTGATGCACATGTTTTCCC
23FPO      TCTTGTAACCTCTTCCACTTGTTAACAAATAATGGTACAGTAATTGATGCACATGTTTTCCC
19FTW      TGAAATGAATTACCATT-----GAACGATGTTGTGGA---TGCGCATGTGTATCC
9VSP       TGAAATGAATTACCATT-----GAACGATGTTGTGGA---TGCGCATGTGTATCC
TIGR4      TGAAATGAATTACCATT-----GAACGATGTTGTGGA---TGCGCATGTGTATCC
23FTW      TTTAATTACTCTGCCGCTTGTAAACCAAATGGTGTGTAGAAAATGCACATGTCTATCC
          *   *   *   *   *   *   *   *   *   *   *   *   *   *   *
14CSR      TAAAAATTCATATAATAAACCAGTTGTAGATAAAAAGAATTGCTGATACTTTGAATTATAA
670        TAAAAATTCATATAATAAACCAGTTGTAGATAAAAAGAATTGCTGATACTTTGAATTATAA
6BF        TAAAAATTCATATAATAAACCAGTTGTAGATAAAAAGAATTGCTGATACTTTGAATTATAA
6BSP       TAAAAATTCATATAATAAACCAGTTGTAGATAAAAAGAATTGCTGATACTTTGAATTATAA
19AH       TAAAAATTCATATAATAAACCAGTTGTAGATAAAAAGAATTGCTGATACTTTGAATTATAA
23FPO      TAAAAATTCATATAATAAACCAGTTGTAGATAAAAAGAATTGCTGATACTTTGAATTATAA
19FTW      AAAAAATACAGAAGCAAAGCCAAAAATGATAAAGATTTCAAAGGTAAGCAAATCCAGA
9VSP       AAAAAATACAGAAGCAAAGCCAAAAATGATAAAGATTTCAAAGGTAAGCAAATCCAGA
TIGR4      AAAAAATACAGAAGCAAAGCCAAAAATGATAAAGATTTCAAAGGTAAGCAAATCCAGA
23FTW      AAAGAATTCGAAGACAACCTACAGCAACGAAAACATTTGATACTGCAGCAGGTTTCGT
          ** ** * *   ** *   ***   *   *
14CSR      CGATCAA-----AATGGTCTGTCTATCGGTAATAAATCCCATATGTTGT----TA
670        CGATCAA-----AATGGTCTGTCTATCGGTAATAAATCCCATATGTTGT----TA
6BF        CGATCAA-----AATGGTCTGTCTATCGGTAATAAATCCCATATGTTGT----TA
6BSP       CGATCAA-----AATGGTCTGTCTATCGGTAATAAATCCCATATGTTGT----TA
19AH       CGATCAA-----AATGGTCTGTCTATCGGTAATAAATCCCATATGTTGT----TA
23FPO      CGATCAA-----AATGGTCTGTCTATCGGTAATAAATCCCATATGTTGT----TA
19FTW      TACACCACGTGTAGATAAAGATACACCTGTGAACCACCAAGTTGGAGATGTTGTAGAGTA
9VSP       TACACCACGTGTAGATAAAGATACACCTGTGAACCACCAAGTTGGAGATGTTGTAGAGTA
TIGR4      TACACCACGTGTAGATAAAGATACACCTGTGAACCACCAAGTTGGAGATGTTGTAGAGTA
23FTW      AGATCCAGGTG---AAAAGGTTTAGCAATGGCACTAAGGTACCGTATATTGT----TA
          * *   ** * *   * *   * *   * *   ** * * * *
14CSR      ATACAACAATCCAAGTAATGCAACATT-----TGCAACTTCATTTTGGTCAGATG
670        ATACAACAATCCAAGTAATGCAACATT-----TGCAACTTCATTTTGGTCAGATG
6BF        ATACAACAATCCAAGTAATGCAACATT-----TGCAACTTCATTTTGGTCAGATG
6BSP       ATACAACAATCCAAGTAATGCAACATT-----TGCAACTTCATTTTGGTCAGATG
19AH       ATACAACAATCCAAGTAATGCAACATT-----TGCAACTTCATTTTGGTCAGATG
23FPO      ATACAACAATCCAAGTAATGCAACATT-----TGCAACTTCATTTTGGTCAGATG
19FTW      CGA-AATTGTTACAAAAATCCAGCACTTGCTAATTATGCAACAGCAAACGGAGCGATA
9VSP       CGA-AATTGTTACAAAAATCCAGCACTTGCTAATTATGCAACAGCAAACGGAGCGATA
TIGR4      CGA-AATTGTTACAAAAATCCAGCACTTGCTAATTATGCAACAGCAAACGGAGCGATA
23FTW      CAACAACATATCCGAAAAACTCAACTCT-----TGCAACAGCTTTCGGTCAGATG
          * **   * * * *   * * *   * * * *   * * * *
14CSR      AAATGACAGAAGGTCTAACTTATAATGAAGA-GTAACAA---TFACTTTGAATAATGTAG
670        AAATGACAGAAGGTCTAACTTATAATGAAGATGTAACAA---TFACTTTGAATAATGTAG
6BF        AAATGACAGAAGGTCTAACTTATAATGAAGATGTAACAA---TFACTTTGAATAATGTAG
6BSP       AAATGACAGAAGGTCTAACTTATAATGAAGATGTAACAA---TFACTTTGAATAATGTAG
19AH       AAATGACAGAAGGTCTAACTTATAATGAAGATGTAACAA---TFACTTTGAATAATGTAG
23FPO      AAATGACAGAAGGTCTAACTTATAATGAAGATGTAACAA---TFACTTTGAATAATGTAG
19FTW      GAATGACTGAAGGTTTGGCATTCAACAAAGGTACAGTGAAAGTAACTGTTGATGATGTTG
9VSP       GAATGACTGAAGGTTTGGCATTCAACAAAGGTACAGTGAAAGTAACTGTTGATGATGTTG
TIGR4      GAATGACTGAAGGTTTGGCATTCAACAAAGGTACAGTGAAAGTAACTGTTGATGATGTTG
23FTW      AAATGACAGAAGGTCTAGATTATAATGGTGATGATGTT---GTTAATTATAATGGTCAAC
          * * * * * * * * * *   * * *   * *   * *   * *

```

Figure 196T

413/487

14CSR CTATGGATCAAGCTGATTATGAAGTCACTAAAGGAAATAATGGCTTAACTTAAAATTAA
670 CTATGGATCAAGCTGATTATGAAGTCACTAAAGGAAATAATGGCTTAACTTAAAATTAA
6BF CTATGGATCAAGCTGATTATGAAGTCACTAAAGGAAATAATGGCTTAACTTAAAATTAA
6BSP CTATGGATCAAGCTGATTATGAAGTCACTAAAGGAAATAATGGCTTAACTTAAAATTAA
19AH CTATGGATCAAGCTGATTATGAAGTCACTAAAGGAAATAATGGCTTAACTTAAAATTAA
23FPO CTATGGATCAAGCTGATTATGAAGTCACTAAAGGAAATAATGGCTTAACTTAAAATTAA
19FTW CACTTGAAGCAGGTGATTATGCTCTAACAGAAGTAGCAACTGGTTTTGATTTGAAATTA
9VSP CACTTGAAGCAGGTGATTATGCTCTAACAGAAGTAGCAACTGGTTTTGATTTGAAATTA
TIGR4 CACTTGAAGCAGGTGATTATGCTCTAACAGAAGTAGCAACTGGTTTTGATTTGAAATTA
23FTW CGTTGATAATTCTCATTACACATTAGAAGCAGGTGCTTATCTTGAAGTTAA
* *

14CSR CAGAAGCAGGTTAGCTAAAATTAATGGTAAGGATGCAGACCAAAAAATCCAAATTACTT
670 CAGAAGCAGGTTAGCTAAAATTAATGGTAAGGATGCAGACCAAAAAATCCAAATTACTT
6BF CAGAAGCAGGTTAGCTAAAATTAATGGTAAGGATGCAGACCAAAAAATCCAAATTACTT
6BSP CAGAAGCAGGTTAGCTAAAATTAATGGTAAGGATGCAGACCAAAAAATCCAAATTACTT
19AH CAGAAGCAGGTTAGCTAAAATTAATGGTAAGGATGCAGACCAAAAAATCCAAATTACTT
23FPO CAGAAGCAGGTTAGCTAAAATTAATGGTAAGGATGCAGACCAAAAAATCCAAATTACTT
19FTW CAGATGCTGGTTAGCTAAAAGTGAATGACCAAAACGCTGAAAAAAGTGTGAAATCACTT
9VSP CAGATGCTGGTTAGCTAAAAGTGAATGACCAAAACGCTGAAAAAAGTGTGAAATCACTT
TIGR4 CAGATGCTGGTTAGCTAAAAGTGAATGACCAAAACGCTGAAAAAAGTGTGAAATCACTT
23FTW ATGAAAAAGGCTTGGAAAGCAATCAACGGTAAGATGCAGAAGCAACATACGTTGAAGT
** *** *

14CSR ACTCAGTACTTTGAACCTCACTTGCTGTTGCAGACATTCCTGAAAGTAACGATATTACAT
670 ACTCAGTACTTTGAACCTCACTTGCTGTTGCAGACATTCCTGAAAGTAACGATATTACAT
6BF ACTCAGTACTTTGAACCTCACTTGCTGTTGCAGACATTCCTGAAAGTAACGATATTACAT
6BSP ACTCAGTACTTTGAACCTCACTTGCTGTTGCAGACATTCCTGAAAGTAACGATATTACAT
19AH ACTCAGTACTTTGAACCTCACTTGCTGTTGCAGACATTCCTGAAAGTAACGATATTACAT
23FPO ACTCAGTACTTTGAACCTCACTTGCTGTTGCAGACATTCCTGAAAGTAACGATATTACAT
19FTW ATTCGGCAACATTGAATGACAAAGCAATGTAGAAGTACCAGAATCTAATGATGTAACAT
9VSP ATTCGGCAACATTGAATGACAAAGCAATGTAGAAGTACCAGAATCTAATGATGTAACAT
TIGR4 ATTCGGCAACATTGAATGACAAAGCAATGTAGAAGTACCAGAATCTAATGATGTAACAT
23FTW ATACTGCAACTTTAAATGCTCTTGCTGTTGCTGATGTGCCAGAAGCGAATGATGTAACAT
* *

14CSR ATCATTACGGAAATCATCAAGATCATGGGAATACTCCAAAACCAACTAAACC---TAATA
670 ATCATTACGGAAATCATCAAGATCATGGGAATACTCCAAAACCAACTAAACC---TAATA
6BF ATCATTACGGAAATCATCAAGATCATGGGAATACTCCAAAACCAACTAAACC---TAATA
6BSP ATCATTACGGAAATCATCAAGATCATGGGAATACTCCAAAACCAACTAAACC---TAATA
19AH ATCATTACGGAAATCATCAAGATCATGGGAATACTCCAAAACCAACTAAACC---TAATA
23FPO ATCATTACGGAAATCATCAAGATCATGGGAATACTCCAAAACCAACTAAACC---TAATA
19FTW TTAAGTATGGTAATAATCCAGATCAGGGAATACTCCAAAGCGAATAAGCCAAATGAAA
9VSP TTAAGTATGGTAATAATCCAGATCAGGGAATACTCCAAAGCGAATAAGCCAAATGAAA
TIGR4 TTAAGTATGGTAATAATCCAGATCAGGGAATACTCCAAAGCGAATAAGCCAAATGAAA
23FTW TCCATTATGGAAACAACCAGGTCATGGTAACACTCCAAAACCAAAACAACC---TAAA
* *

14CSR ATGGTCAAATTACAGTAACTAAGACATGGG-----ACAGTCA-ACCTGCTCCTGAGG
670 ATGGTCAAATTACAGTAACTAAGACATGGG-----ACAGTCA-ACCTGCTCCTGAGG
6BF ATGGTCAAATTACAGTAACTAAGACATGGG-----ACAGTCA-ACCTGCTCCTGAGG
6BSP ATGGTCAAATTACAGTAACTAAGACATGGG-----ACAGTCA-ACCTGCTCCTGAGG
19AH ATGGTCAAATTACAGTAACTAAGACATGGG-----ACAGTCA-ACCTGCTCCTGAGG
23FPO ATGGTCAAATTACAGTAACTAAGACATGGG-----ACAGTCA-ACCTGCTCCTGAGG
19FTW ACGGCGATTTGACATTGACCAAGACATGGGTTGATGCTACAGGTGCACCAATCCGGCTG
9VSP ACGGCGATTTGACATTGACCAAGACATGGGTTGATGCTACAGGTGCACCAATCCGGCTG
TIGR4 ACGGCGATTTGACATTGACCAAGACATGGGTTGATGCTACAGGTGCACCAATCCGGCTG
23FTW ACGGTGAACCTTACAATTACTAAAACATGGGCTGATGCTAAGATGCTCCTAT---AGCAG
* *

Figure 196U

414/487

14CSR GGGTGAAAGCGACTGTTCAACTTGTAATGCCAAGACTGGTGAGAAAAGTCGGTGCTCC--
670 GGGTGAAAGCGACTGTTCAACTTGTAATGCCAAGACTGGTGAGAAAAGTCGGTGCTCC--
6BF GGGTGAAAGCGACTGTTCAACTTGTAATGCCAAGACTGGTGAGAAAAGTCGGTGCTCC--
6BSP GGGTGAAAGCGACTGTTCAACTTGTAATGCCAAGACTGGTGAGAAAAGTCGGTGCTCC--
19AH GGGTGAAAGCGACTGTTCAACTTGTAATGCCAAGACTGGTGAGAAAAGTCGGTGCTCC--
23FPO GGGTGAAAGCGACTGTTCAACTTGTAATGCCAAGACTGGTGAGAAAAGTCGGTGCTCC--
19FTW GAGCTGAAGCAACGTTTCGATTTGGTTAATGCTCAGACTGGTAAAGTTGTACAAAC-----
9VSP GAGCTGAAGCAACGTTTCGATTTGGTTAATGCTCAGACTGGTAAAGTTGTACAAAC-----
TIGR4 GAGCTGAAGCAACGTTTCGATTTGGTTAATGCTCAGACTGGTAAAGTTGTACAAAC-----
23FTW GTGTAGAAGTAACCTTTGATTTGGTAAATGCTCAGACAGGTGAGGTCGTTAAAGTACCTG
* *

14CSR -----TGTAGAACTTTC---AGAAAATAAATGGACATATACTTGGAGTGGTC
670 -----TGTAGAACTTTC---AGAAAATAAATGGACATATACTTGGAGTGGTC
6BF -----TGTAGAACTTTC---AGAAAATAAATGGACATATACTTGGAGTGGTC
6BSP -----TGTAGAACTTTC---AGAAAATAAATGGACATATACTTGGAGTGGTC
19AH -----TGTAGAACTTTC---AGAAAATAAATGGACATATACTTGGAGTGGTC
23FPO -----TGTAGAACTTTC---AGAAAATAAATGGACATATACTTGGAGTGGTC
19FTW -----TGTAACTTTGAC---AACAGACAAAAATACAGTTACTGTTAACGGAT
9VSP -----TGTAACTTTGAC---AACAGACAAAAATACAGTTACTGTTAACGGAT
TIGR4 -----TGTAACTTTGAC---AACAGACAAAAATACAGTTACTGTTAACGGAT
23FTW GACATGAAACAGGTATTGTATTGAATCAACAAATAAATGGACATTTACTGCTACAGGTC
* *

14CSR TAGATAATTCTATTGAATACAAAGTTGAAGAA--GAATAT-AATGGATACTCAGCTGAAT
670 TAGATAATTCTATTGAATACAAAGTTGAAGAA--GAATAT-AATGGATACTCAGCTGAAT
6BF TAGATAATTCTATTGAATACAAAGTTGAAGAA--GAATAT-AATGGATACTCAGCTGAAT
6BSP TAGATAATTCTATTGAATACAAAGTTGAAGAA--GAATAT-AATGGATACTCAGCTGAAT
19AH TAGATAATTCTATTGAATACAAAGTTGAAGAA--GAATAT-AATGGATACTCAGCTGAAT
23FPO TAGATAATTCTATTGAATACAAAGTTGAAGAA--GAATAT-AATGGATACTCAGCTGAAT
19FTW TGGATAAAAATACAGAATATAAATTCGTTGAACGTAGTATAAAAAGGGTATTTCAGCAGATT
9VSP TGGATAAAAATACAGAATATAAATTCGTTGAACGTAGTATAAAAAGGGTATTTCAGCAGATT
TIGR4 TGGATAAAAATACAGAATATAAATTCGTTGAACGTAGTATAAAAAGGGTATTTCAGCAGATT
23FTW TTGATAAATAATACAGAATATAAATTTGTTGAACGGACAATAAAGGGATATTTCAGCAGATT
* *

14CSR ACACAGTAGAGAGCAAAA---GGGAAGTTGGGGGTAAAAAACTGGAAAGATAATAACCCAG
670 ACACAGTAGAGAGCAAAA---GGGAAGTTGGGGGTAAAAAACTGGAAAGATAATAACCCAG
6BF ACACAGTAGAGAGCAAAA---GGGAAGTTGGGGGTAAAAAACTGGAAAGATAATAACCCAG
6BSP ACACAGTAGAGAGCAAAA---GGGAAGTTGGGGGTAAAAAACTGGAAAGATAATAACCCAG
19AH ACACAGTAGAGAGCAAAA---GGGAAGTTGGGGGTAAAAAACTGGAAAGATAATAACCCAG
23FPO ACACAGTAGAGAGCAAAA---GGGAAGTTGGGGGTAAAAAACTGGAAAGATAATAACCCAG
19FTW ATCAAGAAATCACTACAGCTGGAGAAATFGCTGTCAAGAACTGGAAAGACGAAAATCCAA
9VSP ATCAAGAAATCACTACAGCTGGAGAAATFGCTGTCAAGAACTGGAAAGACGAAAATCCAA
TIGR4 ATCAAGAAATCACTACAGCTGGAGAAATFGCTGTCAAGAACTGGAAAGACGAAAATCCAA
23FTW ACCAAACAATTACTGAAACAGGAAAAATFGCTGTTAAAAAACTGGAAAGATAATAACCCAG
* *

14CSR CTCCAATCAATC-TGAAGAACCACGTGTAAAAACATACGGTAAAAAGTTTGTCAAAGTAG
670 CTCCAATCAATCCTGAAGAACCACGTGTAAAAACATACGGTAAAAAGTTTGTCAAAGTAG
6BF CTCCAATCAATCCTGAAGAACCACGTGTAAAAACATACGGTAAAAAGTTTGTCAAAGTAG
6BSP CTCCAATCAATCCTGAAGAACCACGTGTAAAAACATACGGTAAAAAGTTTGTCAAAGTAG
19AH CTCCAATCAATCCTGAAGAACCACGTGTAAAAACATACGGTAAAAAGTTTGTCAAAGTAG
23FPO CTCCAATCAATCCTGAAGAACCACGTGTAAAAACATACGGTAAAAAGTTTGTCAAAGTAG
19FTW AACCCTTGATCCAACAGAGCCAAAAGTTGTTACATATGGTAAAAAGTTTGTCAAAGTTA
9VSP AACCCTTGATCCAACAGAGCCAAAAGTTGTTACATATGGTAAAAAGTTTGTCAAAGTTA
TIGR4 AACCCTTGATCCAACAGAGCCAAAAGTTGTTACATATGGTAAAAAGTTTGTCAAAGTTA
23FTW ACCCAATAAATCCTGAAGAACCACGTGTAAAAACATATGGTAAAAAATTCGTTAAGGTTG
* *

Figure 196V

PCT/US05/27239

14CSR ACCAAAAAGATACTCGTCTAGAAAATGCGCAGTTCGTTGTTAAAAAAGCAGATAGC---A
670 ACCAAAAAGATACTCGTCTAGAAAATGCGCAGTTCGTTGTTAAAAAAGCAGATAGC---A
6BF ACCAAAAAGATACTCGTCTAGAAAATGCGCAGTTCGTTGTTAAAAAAGCAGATAGC---A
6BSP ACCAAAAAGATACTCGTCTAGAAAATGCGCAGTTCGTTGTTAAAAAAGCAGATAGC---A
19AH ACCAAAAAGATACTCGTCTAGAAAATGCGCAGTTCGTTGTTAAAAAAGCAGATAGC---A
23FPO ACCAAAAAGATACTCGTCTAGAAAATGCGCAGTTCGTTGTTAAAAAAGCAGATAGC---A
19FTW ATGATAAAGATAATCGTTAGCTGGGGCAGAATTTGTAATTGCAAATGCTGATAATGCTG
9VSP ATGATAAAGATAATCGTTAGCTGGGGCAGAATTTGTAATTGCAAATGCTGATAATGCTG
TIGR4 ATGATAAAGATAATCGTTAGCTGGGGCAGAATTTGTAATTGCAAATGCTGATAATGCTG
23FTW ACCAAAAAGACGACGCTTAAAGAAGCACAATTCGTTGTGAAGAATG---AGCAA----G
* * * * * ** *

14CSR ATAAATATATTCGCTTTAAGTCAACTGCACAACAAGCT--GCAGATGAAAAAGCAGCAGC
670 ATAAATATATTCGCTTTAAGTCAACTGCACAACAAGCT--GCAGATGAAAAAGCAGCAGC
6BF ATAAATATATTCGCTTTAAGTCAACTGCACAACAAGCT--GCAGATGAAAAAGCAGCAGC
6BSP ATAAATATATTCGCTTTAAGTCAACTGCACAACAAGCT--GCAGATGAAAAAGCAGCAGC
19AH ATAAATATATTCGCTTTAAGTCAACTGCACAACAAGCT--GCAGATGAAAAAGCAGCAGC
23FPO ATAAATATATTCGCTTTAAGTCAACTGCACAACAAGCT--GCAGATGAAAAAGCAGCAGC
19FTW GTCAATATTTAGCACGTAAGCAG--ATAAAGTGAGTCAAGAAGAGAAGCAGTTGGTTGT
9VSP GTCAATATTTAGCACGTAAGCAG--ATAAAGTGAGTCAAGAAGAGAAGCAGTTGGTTGT
TIGR4 GTCAATATTTAGCACGTAAGCAG--ATAAAGTGAGTCAAGAAGAGAAGCAGTTGGTTGT
23FTW GGAAATATCTTGCACTCAAATCTGCAGCACACAAGCT--GTAATGAGAAAGCTGCCGC
* *

14CSR AACTGCAAAACAAAAATTGGATGCAGCGGTAGCAGCTTACA---CAAATGCTGCAGATAA
670 AACTGCAAAACAAAAATTGGATGCAGCGGTAGCAGCTTACA---CAAATGCTGCAGATAA
6BF AACTGCAAAACAAAAATTGGATGCAGCGGTAGCAGCTTACA---CAAATGCTGCAGATAA
6BSP AACTGCAAAACAAAAATTGGATGCAGCGGTAGCAGCTTACA---CAAATGCTGCAGATAA
19AH AACTGCAAAACAAAAATTGGATGCAGCGGTAGCAGCTTACA---CAAATGCTGCAGATAA
23FPO AACTGCAAAACAAAAATTGGATGCAGCGGTAGCAGCTTACA---CAAATGCTGCAGATAA
19FTW TACAACAAGGATGCTTTAGATAGAGCAGTTGCTGCTTATAACGCTCTTACTGCACAACA
9VSP TACAACAAGGATGCTTTAGATAGAGCAGTTGCTGCTTATAACGCTCTTACTGCACAACA
TIGR4 TACAACAAGGATGCTTTAGATAGAGCAGTTGCTGCTTATAACGCTCTTACTGCACAACA
23FTW AGAAGCGAAACAAGCGCTAGATGCAGCGATAGCAGCCTATA---CAAATGCTGCA-GATA
* *

14CSR GCAAGCCGCTCAA-----GCTCTAGTAGATCAAGCACAGCAAGAATACAATGTAGCTTA
670 GCAAGCCGCTCAA-----GCTCTAGTAGATCAAGCACAGCAAGAATACAATGTAGCTTA
6BF GCAAGCCGCTCAA-----GCTCTAGTAGATCAAGCACAGCAAGAATACAATGTAGCTTA
6BSP GCAAGCCGCTCAA-----GCTCTAGTAGATCAAGCACAGCAAGAATACAATGTAGCTTA
19AH GCAAGCCGCTCAA-----GCTCTAGTAGATCAAGCACAGCAAGAATACAATGTAGCTTA
23FPO GCAAGCCGCTCAA-----GCTCTAGTAGATCAAGCACAGCAAGAATACAATGTAGCTTA
19FTW ACAAACTCAGCAAGAAAAAGAGAAAGTTGACAAAGCTCAAGCTGCTTATAATGCTGCTGT
9VSP ACAAACTCAGCAAGAAAAAGAGAAAGTTGACAAAGCTCAAGCTGCTTATAATGCTGCTGT
TIGR4 ACAAACTCAGCAAGAAAAAGAGAAAGTTGACAAAGCTCAAGCTGCTTATAATGCTGCTGT
23FTW A-AAATGCAGCAC-----AAGCTGATAGTAGCTGCGCAAAAAACATATAATGCAATTA
* *

14CSR CAAAGAAGCCAA-----ATTTGGTTATGTTGAAGTAGCTGGAAAAGATGAAGCAATGGT
670 CAAAGAAGCCAA-----ATTTGGTTATGTTGAAGTAGCTGGAAAAGATGAAGCAATGGT
6BF CAAAGAAGCCAA-----ATTTGGTTATGTTGAAGTAGCTGGAAAAGATGAAGCAATGGT
6BSP CAAAGAAGCCAA-----ATTTGGTTATGTTGAAGTAGCTGGAAAAGATGAAGCAATGGT
19AH CAAAGAAGCCAA-----ATTTGGTTATGTTGAAGTAGCTGGAAAAGATGAAGCAATGGT
23FPO CAAAGAAGCCAA-----ATTTGGTTATGTTGAAGTAGCTGGAAAAGATGAAGCAATGGT
19FTW GATTGCTGCCAACAATGCATTTGAATGGGTGGCAGATAAGGACAAATGAAAATGTTGTGAA
9VSP GATTGCTGCCAACAATGCATTTGAATGGGTGGCAGATAAGGACAAATGAAAATGTTGTGAA
TIGR4 GATTGCTGCCAACAATGCATTTGAATGGGTGGCAGATAAGGACAAATGAAAATGTTGTGAA
23FTW CAGAGCAGCTAG-----ATTTGGCTATGTAGAAGTAGAGAGAAAAGAAGATGCGTTAGT
* *

Figure 196W

PCT/US2005/027239 416/487

14CSR TCTTACTTCTAATACGGATGGTCAATTCCAAATTTTCAGGTCTTGCTGCTGGTACTTATAA
670 TCTTACTTCTAATACGGATGGTCAATTCCAAATTTTCAGGTCTTGCTGCTGGTACTTATAA
6BF TCTTACTTCTAATACGGATGGTCAATTCCAAATTTTCAGGTCTTGCTGCTGGTACTTATAA
6BSP TCTTACTTCTAATACGGATGGTCAATTCCAAATTTTCAGGTCTTGCTGCTGGTACTTATAA
19AH TCTTACTTCTAATACGGATGGTCAATTCCAAATTTTCAGGTCTTGCTGCTGGTACTTATAA
23FPO TCTTACTTCTAATACGGATGGTCAATTCCAAATTTTCAGGTCTTGCTGCTGGTACTTATAA
19FTW ATTAGTTTCTGATGCACAAGGTCGCTTTGAAATTACAGGCCCTTCTGTCAGGTACATATTA
9VSP ATTAGTTTCTGATGCACAAGGTCGCTTTGAAATTACAGGCCCTTCTGTCAGGTACATATTA
TIGR4 ATTAGTTTCTGATGCACAAGGTCGCTTTGAAATTACAGGCCCTTCTGTCAGGTACATATTA
23FTW TCTTACTTCTAACACTGATGGTCAATTCCAAATTTTCAGGTCTTGCTGCTGGAGCTACAC
* * * * *

14CSR ATTAGAAGAAATTAAGCTCCAGAAGGTTTTGCGAAAAT---TGATGATGTAGAATTTGT
670 ATTAGAAGAAATTAAGCTCCAGAAGGTTTTGCGAAAAT---TGATGATGTAGAATTTGT
6BF ATTAGAAGAAATTAAGCTCCAGAAGGTTTTGCGAAAAT---TGATGATGTAGAATTTGT
6BSP ATTAGAAGAAATTAAGCTCCAGAAGGTTTTGCGAAAAT---TGATGATGTAGAATTTGT
19AH ATTAGAAGAAATTAAGCTCCAGAAGGTTTTGCGAAAAT---TGATGATGTAGAATTTGT
23FPO ATTAGAAGAAATTAAGCTCCAGAAGGTTTTGCGAAAAT---TGATGATGTAGAATTTGT
19FTW CTTAGAAGAAACAAAACAGCCTGCTGGTTATGCATTACTAAGCCGTCAGAAAATTTGA
9VSP CTTAGAAGAAACAAAACAGCCTGCTGGTTATGCATTACTAAGCCGTCAGAAAATTTGA
TIGR4 CTTAGAAGAAACAAAACAGCCTGCTGGTTATGCATTACTAAGCCGTCAGAAAATTTGA
23FTW GTTGAAGAAACAAAAGCTCCAGAAGGTTTTGCGAAAAT---TGGAGATGTGAAGTTTGA
* * * * *

14CSR TGTTGGAGCAGGTTCTTG-----GAATCAAGGTGAGTTTAATTAATTAATAAAGATGTTCA
670 TGTTGGAGCAGGTTCTTG-----GAATCAAGGTGAGTTTAATTAATTAATAAAGATGTTCA
6BF TGTTGGAGCAGGTTCTTG-----GAATCAAGGTGAGTTTAATTAATTAATAAAGATGTTCA
6BSP TGTTGGAGCAGGTTCTTG-----GAATCAAGGTGAGTTTAATTAATTAATAAAGATGTTCA
19AH TGTTGGAGCAGGTTCTTG-----GAATCAAGGTGAGTTTAATTAATTAATAAAGATGTTCA
23FPO TGTTGGAGCAGGTTCTTG-----GAATCAAGGTGAGTTTAATTAATTAATAAAGATGTTCA
19FTW AGTCACTGCAACTTCTTATTCAGCGACTGGACAAGGCATTGAGTATACTGCTGGTTCAGG
9VSP AGTCACTGCAACTTCTTATTCAGCGACTGGACAAGGCATTGAGTATACTGCTGGTTCAGG
TIGR4 AGTCACTGCAACTTCTTATTCAGCGACTGGACAAGGCATTGAGTATACTGCTGGTTCAGG
23FTW GGTGGAGCAGGTTCTTG-----GAATCAAGGTGAGTTTAATTAATAAAGATGTTCA
* * * * *

14CSR AAAGAATGACGCTACAAAAGTAGTCAACAAAAAATCACTATCCCACAAAACGGGTGGTAT
670 AAAGAATGACGCTACAAAAGTAGTCAACAAAAAATCACTATCCCACAAAACGGGTGGTAT
6BF AAAGAATGACGCTACAAAAGTAGTCAACAAAAAATCACTATCCCACAAAACGGGTGGTAT
6BSP AAAGAATGACGCTACAAAAGTAGTCAACAAAAAATCACTATCCCACAAAACGGGTGGTAT
19AH AAAGAATGACGCTACAAAAGTAGTCAACAAAAAATCACTATCCCACAAAACGGGTGGTAT
23FPO AAAGAATGACGCTACAAAAGTAGTCAACAAAAAATCAGATCCCACAAAACGGGTGGTAT
19FTW TAAAGATGACGCTACAAAAGTAGTCAACAAAAAATCAGATCCCACAAAACGGGTGGTAT
9VSP TAAAGATGACGCTACAAAAGTAGTCAACAAAAAATCAGATCCCACAAAACGGGTGGTAT
TIGR4 TAAAGATGACGCTACAAAAGTAGTCAACAAAAAATCACTATCCCACAAAACGGGTGGTAT
23FTW GAAGAACGACGCTACAAAAGTAGTCAACAAAAAATCAGATCCCACAAAACGGGTGGTAT
* * * * *

14CSR TGGTACAATTATCTTTGCTGTAGCGGGGGCTGCGATTATGGGTATTCAGTGTACGCATA
670 TGGTACAATTATCTTTGCTGTAGCGGGGGCTGCGATTATGGGTATTCAGTGTACGCATA
6BF TGGTACAATTATCTTTGCTGTAGCGGGGGCTGCGATTATGGGTATTCAGTGTACGCATA
6BSP TGGTACAATTATCTTTGCTGTAGCGGGGGCTGCGATTATGGGTATTCAGTGTACGCATA
19AH TGGTACAATTATCTTTGCTGTAGCGGGGGCTGCGATTATGGGTATTCAGTGTACGCATA
23FPO TGGTACAATTATCTTTGCTGTAGCAGGGGGCTGTGATTATGGGTATTCAGTGTACGCATA
19FTW TGGTACAATTATCTTTGCTGTAGCAGGGGGCTGTGATTATGGGTATTCAGTGTACGCATA
9VSP TGGTACAATTATCTTTGCTGTAGCAGGGGGCTGTGATTATGGGTATTCAGTGTACGCATA
TIGR4 TGGTACAATTATCTTTGCTGTAGCGGGGGCTGCGATTATGGGTATTCAGTGTACGCATA
23FTW TGGTACAATTATCTTTGCTGTAGCGGGGGCTGTGATTATGGGTATTCAGTGTACGCATA
* * * * *

Figure 196X

PCT/US05/27239 417/487

14CSR TGTTAAAAACAACAAGATGAGGATCAACTTGCTTAAGTAAGAGAGAAAGGAGCCATTGA
670 TGTTAAAAACAACAAGATGAGGATCAACTTGCTTAAGTAAGAGAGAAAGGAGCCATTGA
6BF TGTTAAAAACAACAAGATGAGGATCAACTTGCTTAAGTAAGAGAGAAAGGAGCCATTGA
6BSP TGTTAAAAACAACAAGATGAGGATCAACTTGCTTAAGTAAGAGAGAAAGGAGCCATTGA
19AH TGTTAAAAACAACAAGATGAGGATCAACTTGCTTAAGTAAGAGAGAAAGGAGCCATTGA
23FPO TGTTAAAAACAACAAGATGAGGATCAACTTGCTTAAGTAAGAGAGAAAGGAGCCATTGA
19FTW TGTTAAAAACAACAAGATGAGGATCAACTTGCTTAAGTAAGAGAGAAAGGAGCCATTGA
9VSP TGTTAAAAACAACAAGATGAGGATCAACTTGCTTAAGTAAGAGAGAAAGGAGCCATTGA
TIGR4 TGTTAAAAACAACAAGATGAGGATCAACTTGCTTAAGTAAGAGAGAAAGGAGCCATTGA
23FTW TGTTAAAAACAACAAGATGAGGATCAACTTGCTTAAGTAAGAGAGAAAGGAGCCATTGA

14CSR TGACAATGCAGAAAATGCAGAAAATG-----
670 TGACAATGCAGAAAATGCAGAAAATG-----
6BF TGACAATGCAGAAAATGCAGAAAATG-----
6BSP TGACAATGCAGAAAATGCAGAAAATG-----
19AH TGACAATGCAGAAAATGCAGAAAATG-----
23FPO TGACAATGCAGAAAATGCAGAAAATG-----
19FTW TGACAATGCAGAAAATGCAGAAAATG-----
9VSP TGACAATGCAGAAAATGCAGAAAATGCAGAAAATGCAGAAAATGCAGAAAA
TIGR4 TGACAATGCAGAAAATGCAGAAAATG-----
23FTW TGACAATGCAGAAAATGCAGAAAATG-----

14CSR --ATTAGTCGTATCTTCTTTGTTATGGCTCTGTGTTTTCTCTTGTATGGGGTGCACATG
670 --ATTAGTCGTATCTTCTTTGTTATGGCTCTGTGTTTTCTCTTGTATGGGGTGCACATG
6BF --ATTAGTCGTATCTTCTTTGTTATGGCTCTGTGTTTTCTCTTGTATGGGGTGCACATG
6BSP --ATTAGTCGTATCTTCTTTGTTATGGCTCTGTGTTTTCTCTTGTATGGGGTGCACATG
19AH --ATTAGTCGTATCTTCTTTGTTATGGCTCTGTGTTTTCTCTTGTATGGGGTGCACATG
23FPO --ATTAGTCGTATCTTCTTTGTTATGGCTCTGTGTTTTCTCTTGTATGGGGTGCACATG
19FTW --ATTAGTCGTATCTTCTTTGTTATGGCTCTGTGTTTTCTCTTGTATGGGGTGCACATG
9VSP TGATTAGTCGTATCTTCTTTGTTATGGCTCTGTGTTTTCTCTTGTATGGGGTGCACATG
TIGR4 --ATTAGTCGTATCTTCTTTGTTATGGCTCTGTGTTTTCTCTTGTATGGGGTGCACATG
23FTW --ATTAGTCGTATCTTCTTTGTTATGGCTCTGTGTTTTCTCTTGTATGGGGTGCACATG

14CSR CAGTCCAAGCGCAAGAAGATCACACGTTGGTCTTGCAATTGGAGAACTATCAGGAGGTGG
670 CAGTCCAAGCGCAAGAAGATCACACGTTGGTCTTGCAATTGGAGAACTATCAGGAGGTGG
6BF CAGTCCAAGCGCAAGAAGATCACACGTTGGTCTTGCAATTGGAGAACTATCAGGAGGTGG
6BSP CAGTCCAAGCGCAAGAAGATCACACGTTGGTCTTGCAATTGGAGAACTATCAGGAGGTGG
19AH CAGTCCAAGCGCAAGAAGATCACACGTTGGTCTTGCAATTGGAGAACTATCAGGAGGTGG
23FPO CAGTCCAAGCGCAAGAAGATCACACGTTGGTCTTGCAATTGGAGAACTATCAGGAGGTGG
19FTW CAGTCCAAGCGCAAGAAGATCACACGTTGGTCTTGCAATTGGAGAACTATCAGGAGGTGG
9VSP CAGTCCAAGCGCAAGAAGATCACACGTTGGTCTTGCAATTGGAGAACTATCAGGAGGTGG
TIGR4 CAGTCCAAGCGCAAGAAGATCACACGTTGGTCTTGCAATTGGAGAACTATCAGGAGGTGG
23FTW CAGTCCAAGCGCAAGAAGATCACACGTTGGTCTTGCAATTGGAGAACTATCAGGAGGTGG

14CSR TTAGTCAATTGCCATCTCGTGATGGTCATCGGTTGCAAGTATGGAAGTTGGATGATTCGT
670 TTAGTCAATTGCCATCTCGTGATGGTCATCGGTTGCAAGTATGGAAGTTGGATGATTCGT
6BF TTAGTCAATTGCCATCTCGTGATGGTCATCGGTTGCAAGTATGGAAGTTGGATGATTCGT
6BSP TTAGTCAATTGCCATCTCGTGATGGTCATCGGTTGCAAGTATGGAAGTTGGATGATTCGT
19AH TTAGTCAATTGCCATCTCGTGATGGTCATCGGTTGCAAGTATGGAAGTTGGATGATTCGT
23FPO TTAGTCAATTGCCATCTCGTGATGGTCATCGGTTGCAAGTATGGAAGTTGGATGATTCGT
19FTW TTAGTCAATTGCCATCTCGTGATGGTCATCGGTTGCAAGTATGGAAGTTGGATGATTCGT
9VSP TTAGTCAATTGCCATCTCGTGATGGTCATCGGTTGCAAGTATGGAAGTTGGATGATTCGT
TIGR4 TTAGTCAATTGCCATCTCGTGATGGTCATCGGTTGCAAGTATGGAAGTTGGATGATTCGT
23FTW TTAGTCAATTGCCATCTCGTGATGGTCATCGGTTGCAAGTATGGAAGTTGGATGATTCGT

Figure 196Y

14CSR ATTCCTATGATGATCGGGTGCAAATTGTAAGAGACTTGCATTTCGTGGGATGAGAATAAAC
670 ATTCCTATGATGATCGGGTGCAAATTGTAAGAGACTTGCATTTCGTGGGATGAGAATAAAC
6BF ATTCCTATGATGATCGGGTGCAAATTGTAAGAGACTTGCATTTCGTGGGATGAGAATAAAC
6BSP ATTCCTATGATGATCGGGTGCAAATTGTAAGAGACTTGCATTTCGTGGGATGAGAATAAAC
19AH ATTCCTATGATGATCGGGTGCAAATTGTAAGAGACTTGCATTTCGTGGGATGAGAATAAAC
23FPO ATTCCTATGATAATCGGGTGCAAATTGTGAGAGACTTGCATTTCGTGGGATGAGAATAAAC
19FTW ATTCCTATGATAATCGGGTGCAAATTGTGAGAGACTTGCATTTCGTGGGATGAGAATAAAC
9VSP ATTCCTATGATAATCGGGTGCAAATTGTGAGAGACTTGCATTTCGTGGGATGAGAATAAAC
TIGR4 ATTCCTATGATGATCGGGTGCAAATTGTAAGAGACTTGCATTTCGTGGGATGAGAATAAAC
23FTW ATTCCTATGATAATCGGGTGCAAATTGTGAGAGACTTGCATTTCGTGGGATGAGAATAAAC

14CSR TTTCTTCTTTCAAAAAGACTTCGTTTGAGATGACCTTCCTTGAGAATCAGATTGAAGTAT
670 TTTCTTCTTTCAAAAAGACTTCGTTTGAGATGACCTTCCTTGAGAATCAGATTGAAGTAT
6BF TTTCTTCTTTCAAAAAGACTTCGTTTGAGATGACCTTCCTTGAGAATCAGATTGAAGTAT
6BSP TTTCTTCTTTCAAAAAGACTTCGTTTGAGATGACCTTCCTTGAGAATCAGATTGAAGTAT
19AH TTTCTTCTTTCAAAAAGACTTCGTTTGAGATGACCTTCCTTGAGAATCAGATTGAAGTAT
23FPO TTTCTTCTTTCAAAAAGACTTCGTTTGAGATGACCTTCCTTGAGAATCAGATTGAAGTAT
19FTW TTTCTTCTTTCAAAAAGACTTCGTTTGAGATGACCTTCCTTGAGAATCAGATTGAAGTAT
9VSP TTTCTTCTTTCAAAAAGACTTCGTTTGAGATGACCTTCCTTGAGAATCAGATTGAAGTAT
TIGR4 TTTCTTCTTTCAAAAAGACTTCGTTTGAGATGACCTTCCTTGAGAATCAGATTGAAGTAT
23FTW TTTCTTCTTTCAAAAAGACTTCGTTTGAGATGACCTTCCTTGAGAATCAGATTGAAGTAT

14CSR CTCATATCCAAATGGTCTTTACTATGTTTCGCTCTATTATCCAGACGGATGCGGTTTCTT
670 CTCATATCCAAATGGTCTTTACTATGTTTCGCTCTATTATCCAGACGGATGCGGTTTCTT
6BF CTCATATCCAAATGGTCTTTACTATGTTTCGCTCTATTATCCAGACGGATGCGGTTTCTT
6BSP CTCATATCCAAATGGTCTTTACTATGTTTCGCTCTATTATCCAGACGGATGCGGTTTCTT
19AH CTCATATCCAAATGGTCTTTACTATGTTTCGCTCTATTATCCAGACGGATGCGGTTTCTT
23FPO CTCATATCCAAATGGTCTTTACTATGTTTCGCTCTATTATCCAGACGGATGCGGTTTCTT
19FTW CTCATATCCAAATGGTCTTTACTATGTTTCGCTCTATTATCCAGACGGATGCGGTTTCTT
9VSP CTCATATCCAAATGGTCTTTACTATGTTTCGCTCTATTATCCAGACGGATGCGGTTTCTT
TIGR4 CTCATATCCAAATGGTCTTTACTATGTTTCGCTCTATTATCCAGACGGATGCGGTTTCTT
23FTW CTCATATCCAAATGGTCTTTACTATGTTTCGCTCTATTATCCAGACGGATGCGGTTTCTT

14CSR ATCCAGCTGAATTTCTTTTTGAAATGACAGATCAAACGGTAGAGCCTTTGGTCATTGTAG
670 ATCCAGCTGAATTTCTTTTTGAAATGACAGATCAAACGGTAGAGCCTTTGGTCATTGTAG
6BF ATCCAGCTGAATTTCTTTTTGAAATGACAGATCAAACGGTAGAGCCTTTGGTCATTGTAG
6BSP ATCCAGCTGAATTTCTTTTTGAAATGACAGATCAAACGGTAGAGCCTTTGGTCATTGTAG
19AH ATCCAGCTGAATTTCTTTTTGAAATGACAGATCAAACGGTAGAGCCTTTGGTCATTGTAG
23FPO ATCCAGCTGAATTTCTTTTTGAAATGACAGATCAAACGGTAGAGCCTTTGGTCATTGTAG
19FTW ATCCAGCTGAATTTCTTTTTGAAATGACAGATCAAACGGTAGAGCCTTTGGTCATTGTAG
9VSP ATCCAGCTGAATTTCTTTTTGAAATGACAGATCAAACGGTAGAGCCTTTGGTCATTGTAG
TIGR4 ATCCAGCTGAATTTCTTTTTGAAATGACAGATCAAACGGTAGAGCCTTTGGTCATTGTAG
23FTW ATCCAGCTGAATTTCTTTTTGAAATGACAGATCAAACGGTAGAGCCTTTGGTCATTGTAG

14CSR CGAAAAAACAGATACAATGACAACAAAGGTGAAGCTGATAAAGGTGGATCAAGACCACA
670 CGAAAAAACAGATACAATGACAACAAAGGTGAAGCTGATAAAGGTGGATCAAGACCACA
6BF CGAAAAAACAGATACAATGACAACAAAGGTGAAGCTGATAAAGGTGGATCAAGACCACA
6BSP CGAAAAAACAGATACAATGACAACAAAGGTGAAGCTGATAAAGGTGGATCAAGACCACA
19AH CGAAAAAACAGATACAATGACAACAAAGGTGAAGCTGATAAAGGTGGATCAAGACCACA
23FPO CGAAAAAAGCAGATACGGTGACAACAAAGGTGAAGCTGATAAAGGTGGATCAAGACCACA
19FTW CGAAAAAAGCAGATACGGTGACAACAAAGGTGAAGCTGATAAAGGTGGATCAAGACCACA
9VSP CGAAAAAAGCAGATACGGTGACAACAAAGGTGAAGCTGATAAAGGTGGATCAAGACCACA
TIGR4 CGAAAAAACAGATACAATGACAACAAAGGTGAAGCTGATAAAGGTGGATCAAGACCACA
23FTW CGAAAAAAGCAGATACGGTGACAACAAAGGTGAAGCTGATAAAGGTGGATCAAGACCACA

Figure 196X

14CSR ATCGCTTGGAGGGTGTCCGGCTTAAATTGGTATCAGTAGCAAGAGATGGTTCTGAAAAAG
670 ATCGCTTGGAGGGTGTCCGGCTTAAATTGGTATCAGTAGCAAGAGATGGTTCTGAAAAAG
6BF ATCGCTTGGAGGGTGTCCGGCTTAAATTGGTATCAGTAGCAAGAGATGGTTCTGAAAAAG
6BSP ATCGCTTGGAGGGTGTCCGGCTTAAATTGGTATCAGTAGCAAGAGATGGTTCTGAAAAAG
19AH ATCGCTTGGAGGGTGTCCGGCTTAAATTGGTATCAGTAGCAAGAGATGGTTCTGAAAAAG
23FPO ATCGCTTGGAGGGTGTCCGGCTTAAATTGGTATCAGTAGCAAGAGATGGTTCTGAAAAAG
19FTW ATCGCTTGGAGGGTGTCCGGCTTAAATTGGTATCAGTAGCAAGAGATGGTTCTGAAAAAG
9VSP ATCGCTTGGAGGGTGTCCGGCTTAAATTGGTATCAGTAGCAAGAGATGGTTCTGAAAAAG
TIGR4 ATCGCTTGGAGGGTGTCCGGCTTAAATTGGTATCAGTAGCAAGAGATGGTTCTGAAAAAG
23FTW ATCGCTTGGAGGGTGTCCGGCTTAAATTGGTATCAGTAGCAAGAGATGGTTCTGAAAAAG

14CSR AGGTTCCCTTGATTGGAGAATACCGTTACAGTTCCTTCTGGTCAAGTAGGGAGAACTCTCT
670 AGGTTCCCTTGATTGGAGAATACCGTTACAGTTCCTTCTGGTCAAGTAGGGAGAACTCTCT
6BF AGGTTCCCTTGATTGGAGAATACCGTTACAGTTCCTTCTGGTCAAGTAGGGAGAACTCTCT
6BSP AGGTTCCCTTGATTGGAGAATACCGTTACAGTTCCTTCTGGTCAAGTAGGGAGAACTCTCT
19AH AGGTTCCCTTGATTGGAGAATACCGTTACAGTTCCTTCTGGTCAAGTAGGGAGAACTCTCT
23FPO AGGTTCCCTTGATTGGAGAATACCGTTACAGTTCCTTCTGGTCAAGTAGGGAGAACTCTCT
19FTW AGGTTCCCTTGATTGGAGAATACCGTTACAGTTCCTTCTGGTCAAGTAGGGAGAACTCTCT
9VSP AGGTTCCCTTGATTGGAGAATACCGTTACAGTTCCTTCTGGTCAAGTAGGGAGAACTCTCT
TIGR4 AGGTTCCCTTGATTGGAGAATACCGTTACAGTTCCTTCTGGTCAAGTAGGGAGAACTCTCT
23FTW AGGTTCCCTTGATTGGAGAATACCGTTACAGTTCCTTCTGGTCAAGTAGGGAGAACTCTCT

14CSR ATACTGATAAAAAATGGAGAGATTTTTGTGACAAATCTTCCTCTTGGGAACTATCGTTTCA
670 ATACTGATAAAAAATGGAGAGATTTTTGTGACAAATCTTCCTCTTGGGAACTATCGTTTCA
6BF ATACTGATAAAAAATGGAGAGATTTTTGTGACAAATCTTCCTCTTGGGAACTATCGTTTCA
6BSP ATACTGATAAAAAATGGAGAGATTTTTGTGACAAATCTTCCTCTTGGGAACTATCGTTTCA
19AH ATACTGATAAAAAATGGAGAGATTTTTGTGACAAATCTTCCTCTTGGGAACTATCGTTTCA
23FPO ATACTGATAAAAAATGGAGAGATTTTTGTGACAAATCTTCCTCTTGGGAACTATCGTTTCA
19FTW ATACTGATAAAAAATGGAGAGATTTTTGTGACAAATCTTCCTCTTGGGAACTATCGTTTCA
9VSP ATACTGATAAAAAATGGAGAGATTTTTGTGACAAATCTTCCTCTTGGGAACTATCGTTTCA
TIGR4 ATACTGATAAAAAATGGAGAGATTTTTGTGACAAATCTTCCTCTTGGGAACTATCGTTTCA
23FTW ATACTGATAAAAAATGGAGAGATTTTTGTGACAAATCTTCCTCTTGGGAACTATCGTTTCA

14CSR AGGAGGTGGAGCCACTGGCAGGCTATGCTGTTACGACGCTGGATACGGATGTCCAGCTGG
670 AGGAGGTGGAGCCACTGGCAGGCTATGCTGTTACGACGCTGGATACGGATGTCCAGCTGG
6BF AGGAGGTGGAGCCACTGGCAGGCTATGCTGTTACGACGCTGGATACGGATGTCCAGCTGG
6BSP AGGAGGTGGAGCCACTGGCAGGCTATGCTGTTACGACGCTGGATACGGATGTCCAGCTGG
19AH AGGAGGTGGAGCCACTGGCAGGCTATGCTGTTACGACGCTGGATACGGATGTCCAGCTGG
23FPO AGGAGGTGGAGCCACTGGCAGGCTATGCTGTTACGACGATGGATACGGATGTCCAGTTGG
19FTW AGGAGGTGGAGCCACTGGCAGGCTATACTGTTACGACGATGGATACGGATGTCCAGTTGG
9VSP AGGAGGTGGAGCCACTGGCAGGCTATACTGTTACGACGATGGATACGGATGTCCAGTTGG
TIGR4 AGGAGGTGGAGCCACTGGCAGGCTATACTGTTACGACGATGGATACGGATGTCCAGTTGG
23FTW AGGAGGTGGAGCCACTGGCAGGCTATACTGTTACGACGATGGATACGGATGTCCAGTTGG

14CSR TAGATCATCAGCTGGTGACGATTACGGTTGTCAATCAGAAATTACCACGTGGCAATGTTG
670 TAGATCATCAGCTGGTGACGATTACGGTTGTCAATCAGAAATTACCACGTGGCAATGTTG
6BF TAGATCATCAGCTGGTGACGATTACGGTTGTCAATCAGAAATTACCACGTGGCAATGTTG
6BSP TAGATCATCAGCTGGTGACGATTACGGTTGTCAATCAGAAATTACCACGTGGCAATGTTG
19AH TAGATCATCAGCTGGTGACGATTACGGTTGTCAATCAGAAATTACCACGTGGCAATGTTG
23FPO TAGATCATCAGCTGGTGACGATTACGGTTGTCAATCAGAAATTACCACGTGGCAATGTTG
19FTW TAGATCATCAGCTGGTGACGATTACGGTTGTCAATCAGAAATTACCACGTGGCAATGTTG
9VSP TAGATCATCAGCTGGTGACGATTACGGTTGTCAATCAGAAATTACCACGTGGCAATGTTG
TIGR4 TAGATCATCAGCTGGTGACGATTACGGTTGTCAATCAGAAATTACCACGTGGCAATGTTG
23FTW TAGATCATCAGCTGGTGACGATTACGGTTGTCAATCAGAAATTACCACGTGGCAATGTTG

Figure 196AA

PCT/US05/27239 420/487

14CSR ACTTTATGAAGGTGGATGGTCGGACCAATACCTCTCTTCAAGGGGCAATGTTCAAAGTCA
670 ACTTTATGAAGGTGGATGGTCGGACCAATACCTCTCTTCAAGGGGCAATGTTCAAAGTCA
6BF ACTTTATGAAGGTGGATGGTCGGACCAATACCTCTCTTCAAGGGGCAATGTTCAAAGTCA
6BSP ACTTTATGAAGGTGGATGGTCGGACCAATACCTCTCTTCAAGGGGCAATGTTCAAAGTCA
19AH ACTTTATGAAGGTGGATGGTCGGACCAATACCTCTCTTCAAGGGGCAATGTTCAAAGTCA
23FPO ACTTTATGAAGGTGGATGGTCGGACCAATACCTCTCTTCAAGGGGCAATGTTCAAAGTCA
19FTW ACTTTATGAAGGTGGATGGTAGGACCAATACCTCTCTTCAAGGGGCAATGTTCAAAGTCA
9VSP ACTTTATGAAGGTGGATGGTAGGACCAATACCTCTCTTCAAGGGGCAATGTTCAAAGTCA
TIGR4 ACTTTATGAAGGTGGATGGTCGGACCAATACCTCTCTTCAAGGGGCAATGTTCAAAGTCA
23FTW ACTTTATGAAGGTGGATGGTCGGACCAATACCTCTCTTCAAGGGGCAATGTTCAAAGTCA

14CSR TGAAAGAAGAAAGCGGACACTATACTCCTGTTCTTCAAATGGTAAGGAAGTAGTTGTAA
670 TGAAAGAAGAAAGCGGACACTATACTCCTGTTCTTCAAATGGTAAGGAAGTAGTTGTAA
6BF TGAAAGAAGAAAGCGGACACTATACTCCTGTTCTTCAAATGGTAAGGAAGTAGTTGTAA
6BSP TGAAAGAAGAAAGCGGACACTATACTCCTGTTCTTCAAATGGTAAGGAAGTAGTTGTAA
19AH TGAAAGAAGAAAGCGGACACTATACTCCTGTTCTTCAAATGGTAAGGAAGTAGTTGTAA
23FPO TGAAAGAAGAAAGCGGACACTATACTCCTGTTCTTCAAATGGTAAGGAAGTAGTTGTGG
19FTW TGAAAGAAGAAAGCGGACACTATACTCCTGTTCTTCAAATGGTAAGGAAGTAGTTGTGG
9VSP TGAAAGAAGAAAGCGGACACTATACTCCTGTTCTTCAAATGGTAAGGAAGTAGTTGTGG
TIGR4 TGAAAGAAGAAAGCGGACACTATACTCCTGTTCTTCAAATGGTAAGGAAGTAGTTGTAA
23FTW TGAAAGAAGAAAGCGGACACTATACTCCTGTTCTTCAAATGGTAAGGAAGTAGTTGTGG

14CSR CATCAGGGAAAGATGGTCGTTCCGAGTGGAAAGGTCTAGAGTATGGGACATACTATTTAT
670 CATCAGGGAAAGATGGTCGTTCCGAGTGGAAAGGTCTAGAGTATGGGACATACTATTTAT
6BF CATCAGGGAAAGATGGTCGTTCCGAGTGGAAAGGTCTAGAGTATGGGACATACTATTTAT
6BSP CATCAGGGAAAGATGGTCGTTCCGAGTGGAAAGGTCTAGAGTATGGGACATACTATTTAT
19AH CATCAGGGAAAGATGGTCGTTCCGAGTGGAAAGGTCTAGAGTATGGGACATACTATTTAT
23FPO CATCAGGGAAAGATGGTCGTTCCGAGTGGAAAGGTCTAGAGTATGGGACATACTATTTAT
19FTW CATCAGGGAAAGATGGTCGTTCCGAGTGGAAAGGTCTAGAGTATGGGACATACTATTTAT
9VSP CATCAGGGAAAGATGGTCGTTCCGAGTGGAAAGGTCTAGAGTATGGGACATACTATTTAT
TIGR4 CATCAGGGAAAGATGGTCGTTCCGAGTGGAAAGGTCTAGAGTATGGGACATACTATTTAT
23FTW CATCAGGGAAAGATGGTCGTTCCGAGTGGAAAGGTCTAGAGTATGGGACATACTATTTAT

14CSR GGGAGCTCCAAGCTCCAAGTGGTTATGTTCAATTAACATCGCCTGTTTCCTTTACAATCG
670 GGGAGCTCCAAGCTCCAAGTGGTTATGTTCAATTAACATCGCCTGTTTCCTTTACAATCG
6BF GGGAGCTCCAAGCTCCAAGTGGTTATGTTCAATTAACATCGCCTGTTTCCTTTACAATCG
6BSP GGGAGCTCCAAGCTCCAAGTGGTTATGTTCAATTAACATCGCCTGTTTCCTTTACAATCG
19AH GGGAGCTCCAAGCTCCAAGTGGTTATGTTCAATTAACATCGCCTGTTTCCTTTACAATCG
23FPO GGGAGCTCCAAGCTCCAAGTGGTTATGTTCAATTAACATCGCCTGTTTCCTTTACAATCG
19FTW GGGAGCTCCAAGCTCCAAGTGGTTATGTTCAATTAACATCGCCTGTTTCCTTTACAATCG
9VSP GGGAGCTCCAAGCTCCAAGTGGTTATGTTCAATTAACATCGCCTGTTTCCTTTACAATCG
TIGR4 GGGAGCTCCAAGCTCCAAGTGGTTATGTTCAATTAACATCGCCTGTTTCCTTTACAATCG
23FTW GGGAGCTCCAAGCTCCAAGTGGTTATGTTCAATTAACATCGCCTGTTTCCTTTACAATCG

14CSR GGAAAGATACTCGTAAGGAACTGGTAACAGTGGTTAAAAATAACAAGCGACCACGGATTG
670 GGAAAGATACTCGTAAGGAACTGGTAACAGTGGTTAAAAATAACAAGCGACCACGGATTG
6BF GGAAAGATACTCGTAAGGAACTGGTAACAGTGGTTAAAAATAACAAGCGACCACGGATTG
6BSP GGAAAGATACTCGTAAGGAACTGGTAACAGTGGTTAAAAATAACAAGCGACCACGGATTG
19AH GGAAAGATACTCGTAAGGAACTGGTAACAGTGGTTAAAAATAACAAGCGACCACGGATTG
23FPO GGAAAGATACTCGTAAGGAACTGGTAACAGTGGTTAAAAATAACAAGCGACCACGGATTG
19FTW GGAAAGATACTCGTAAGGAACTGGTAACAGTGGTTAAAAATAACAAGCGACCACGGATTG
9VSP GGAAAGATACTCGTAAGGAACTGGTAACAGTGGTTAAAAATAACAAGCGACCACGGATTG
TIGR4 GGAAAGATACTCGTAAGGAACTGGTAACAGTGGTTAAAAATAACAAGCGACCACGGATTG
23FTW GGAAAGATACTCGTAAGGAACTGGTAACAGTGGTTAAAAATAACAAGCGACCACGGATTG

Figure 196AB

14CSR ATGTGCCAGATACAGGGGAAGAAACCTTGTATATCTTGATGCTTGTGCCATTTTGTGTTGT
670 ATGTGCCAGATACAGGGGAAGAAACCTTGTATATCTTGATGCTTGTGCCATTTTGTGTTGT
6BF ATGTGCCAGATACAGGGGAAGAAACCTTGTATATCTTGATGCTTGTGCCATTTTGTGTTGT
6BSP ATGTGCCAGATACAGGGGAAGAAACCTTGTATATCTTGATGCTTGTGCCATTTTGTGTTGT
19AH ATGTGCCAGATACAGGGGAAGAAACCTTGTATATCTTGATGCTTGTGCCATTTTGTGTTGT
23FPO ATGTGCCAGATACAGGGGAAGAAACCTTGTATATCTTGATGCTTGTGCCATTTTGTGTTGT
19FTW ATGTGCCAGATACAGGGGAAGAAACCTTGTATATCTTGATGCTTGTGCCATTTTGTGTTGT
9VSP ATGTGCCAGATACAGGGGAAGAAACCTTGTATATCTTGATGCTTGTGCCATTTTGTGTTGT
TIGR4 ATGTGCCAGATACAGGGGAAGAAACCTTGTATATCTTGATGCTTGTGCCATTTTGTGTTGT
23FTW ATGTGCCAGATACAGGGGAAGAAACCTTGTATATCTTGATGCTTGTGCCATTTTGTGTTGT

14CSR TTGGTAGTGGTTATTATCTTACGAAAAAACC AAATAACTGATATTCAATGTACATCATTA
670 TTGGTAGTGGTTATTATCTTACGAAAAAACC AAATAACTGATATTCAATGTACATCATTA
6BF TTGGTAGTGGTTATTATCTTACGAAAAAACC AAATAACTGATATTCAATGTACATCATTA
6BSP TTGGTAGTGGTTATTATCTTACGAAAAAACC AAATAACTGATATTCAATGTACATCATTA
19AH TTGGTAGTGGTTATTATCTTACGAAAAAACC AAATAACTGATATTCAATGTACATCATTA
23FPO TTGGTAGTGGCTATTATCTTACGAAAAAACC AAATAACTGATATTCAATGTACATCATTA
19FTW TTGGTAGTGGCTATTATCTTACGAAAAAACC AAATAACTGATATTCAATGTACATCATTA
9VSP TTGGTAGTGGCTATTATCTTACGAAAAAACC AAATAACTGATATTCAATGTACATCATTA
TIGR4 TTGGTAGTGGCTATTATCTTACGAAAAAACC AAATAACTGATATTCAATGTACATCATTA
23FTW TTGGTAGTGGCTATTATCTTACGAAAAAACC AAATAACTGATATTCAATGTACATCATTA

14CSR TGAAAAAGATAGCAGGCTGAAGGGAAGACCAGAGTACTCTGAGGTGATGTTAATCAGGAA
670 TGAAAAAGATAGCAGGCTGAAGGGAAGACCAGAGTACTCTGAGGTGATGTTAATCAGGAA
6BF TGAAAAAGATAGCAGGCTGAAGGGAAGACCAGAGTACTCTGAGGTGATGTTAATCAGGAA
6BSP TGAAAAAGATAGCAGGCTGAAGGGAAGACCAGAGTACTCTGAGGTGATGTTAATCAGGAA
19AH TGAAAAAGATAGCAGGCTGAAGGGAAGACCAGAGTACTCTGAGGTGATGTTAATCAGGAA
23FPO TGAAAAAGATAGCAGGCTGAAGGGAAGACCAGAGTACTCTGAGGTGATGTTAATCAGGAA
19FTW TGAAAAAGATAGCAGGCTGAAGGGAAGACCAGAGTACTCTGAGGTGATGTTAATCAGGAA
9VSP TGAAAAAGATAGCAGGCTGAAGGGAAGACCAGAGTACTCTGAGGTGATGTTAATCAGGAA
TIGR4 TGAAAAAGATAGCAGGCTGAAGGGAAGACCAGAGTACTCTGAGGTGATGTTAATCAGGAA
23FTW TGAAAAAGATAGCAGGCTGAAGGGAAGACCAGAGTACTCTGAGGTGATGTTAATCAGGAA

14CSR TCATGGTGATGTGGCATGAATCACAATAACGGATATGAGGCTGGGCAGATTGTGCCAGCC
670 TCATGGTGATGTGGCATGAATCACAATAACGGATATGAGGCTGGGCAGATTGTGCCAGCC
6BF TCATGGTGATGTGGCATGAATCACAATAACGGATATGAGGCTGGGCAGATTGTGCCAGCC
6BSP TCATGGTGATGTGGCATGAATCACAATAACGGATATGAGGCTGGGCAGATTGTGCCAGCC
19AH TCATGGTGATGTGGCATGAATCACAATAACGGATATGAGGCTGGGCAGATTGTGCCAGCC
23FPO TCATGGTGATTTGGCATGAATCATAATAACGGATATGAGGCTGGGCAGATTGTGCCAGCC
19FTW TCATGGTGATTTGGCATGAATCATAATAACGGATATGAGGCTGGGCAGATTGTGCCAGCC
9VSP TCATGGTGATTTGGCATGAATCATAATAACGGATATGAGGCTGGGCAGATTGTGCCAGCC
TIGR4 TCATGGTGATGTGGCATGAATCACAATAACGGATATGAGGCTGGGCAGATTGTGCCAGCC
23FTW TCATGGTGATTTGGCATGAATCACAATAACGGATATGAGGCTGGGCAGATTGTGCCAGCC

14CSR TCATTGTGGGTTATTGTTTGTAAAACGATAGGACTGGTCTGGTAATCATTTTAGGAATGG
670 TCATTGTGGGTTATTGTTTGTAAAACGATAGGACTGGTCTGGTAATCATTTTAGGAATGG
6BF TCATTGTGGGTTATTGTTTGTAAAACGATAGGACTGGTCTGGTAATCATTTTAGGAATGG
6BSP TCATTGTGGGTTATTGTTTGTAAAACGATAGGACTGGTCTGGTAATCATTTTAGGAATGG
19AH TCATTGTGGGTTATTGTTTGTAAAACGATAGGACTGGTCTGGTAATCATTTTAGGAATGG
23FPO TCATTGTGGGTTATTGTTTGTAAAACGATAGGACTGGTCTGGTAATCATTTTAGGAATGG
19FTW TCATTGTGGGTTATTGTTTGTAAAACGATAGGACTGGTCTGGTAATCATTTTAGGAATGG
9VSP TCATTGTGGGTTATTGTTTGTAAAACGATAGGACTGGTCTGGTAATCATTTTAGGAATGG
TIGR4 TCATTGTGGGTTATTGTTTGTAAAACGATAGGACTGGTCTGGTAATCATTTTAGGAATGG
23FTW TCATTGTGGGTTATTGTTTGTAAAACGATAGGACTGGTCTGGTAATCATTTTAGGAATGG

Figure 196AC

14CSR ACAGGACTGGGATTCTGATTTAAAATGGATGGTGAATCAGAAAGAAATGAGATTTTCTCG
670 ACAGGACTGGGATTCTGATTTAAAATGGATGGTGAATCAGAAAGAAATGAGATTTTCTCG
6BF ACAGGACTGGGATTCTGATTTAAAATGGATGGTGAATCAGAAAGAAATGAGATTTTCTCG
6BSP ACAGGACTGGGATTCTGATTTAAAATGGATGGTGAATCAGAAAGAAATGAGATTTTCTCG
19AH ACAGGACTGGGATTCTGATTTAAAATGGATGGTGAATCAGAAAGAAATGAGATTTTCTCG
23FPO ACAGGACTGGGATTCTGATTTAAAATGGATGGTGAATCAGAAAGAAATGAGATTTTCTCG
19FTW ACAGGACTGGGATTCTGATTTAAAATGGATGGTGAATCAGAAAGAAATGAGATTTTCTCG
9VSP ACAGGACTGGGATTCTGATTTAAAATGGATGGTGAATCAGAAAGAAATGAGATTTTCTCG
TIGR4 ACAGGACTGGGATTCTGATTTAAAATGGATGGTGAATCAGAAAGAAATGAGATTTTCTCG
23FTW ACAGGACTGGGATTCTGATTTAAAATGGATGGTGAATCAGAAAGAAATGAGATTTTCTCG

14CSR TTTCTCTTAGCAGATAGGATTGCTGTGTAGGAAAAGCGATAAAAATGATGAGTTTGAAGAT
670 TTTCTCTTAGCAGATAGGATTGCTGTGTAGGAAAAGCGATAAAAATGATGAGTTTGAAGAT
6BF TTTCTCTTAGCAGATAGGATTGCTGTGTAGGAAAAGCGATAAAAATGATGAGTTTGAAGAT
6BSP TTTCTCTTAGCAGATAGGATTGCTGTGTAGGAAAAGCGATAAAAATGATGAGTTTGAAGAT
19AH TTTCTCTTAGCAGATAGGATTGCTGTGTAGGAAAAGCGATAAAAATGATGAGTTTGAAGAT
23FPO TTTCTCTTAGCAGATAGGATTGCTGTGTAGGAAAAGCGATAAAAATGATGAGTTTGAAGAT
19FTW TTTCTCTTAGCAGATAGGATTGCTGTGTAGGAAAAGCGATAAAAATGATGAGTTTGAAGAT
9VSP TTTCTCTTAGCAGATAGGATTGCTGTGTAGGAAAAGCGATAAAAATGATGAGTTTGAAGAT
TIGR4 TTTCTCTTAGCAGATAGGATTGCTGTGTAGGAAAAGCGATAAAAATGATGAGTTTGAAGAT
23FTW TTTCTCTTAGCAGATAGGATTGCTGTGTAGGAAAAGCGATAAAAATGATGAGTTTGAAGAT

14CSR AAAGGGATGCTGATAAAAA-TGGTAAAAACAAAAAGCAAAAACGAAATAATCTCCTATT
670 AAAGGGATGCTGATAAAAA-TGGTAAAAACAAAAAGCAAAAACGAAATAATCTCCTATT
6BF AAAGGGATGCTGATAAAAA-TGGTAAAAACAAAAAGCAAAAACGAAATAATCTCCTATT
6BSP AAAGGGATGCTGATAAAAA-TGGTAAAAACAAAAAGCAAAAACGAAATAATCTCCTATT
19AH AAAGGGATGCTGATAAAAA-TGGTAAAAACAAAAAGCAAAAACGAAATAATCTCCTATT
23FPO AAAGGAATGCTGATAAAAAATGGCAAAAACAAAAAGCAAAAACGAAACAATCTCCTATT
19FTW AAAGGAATGCTGATAAAAAATGGCAAAAACAAAAAGCAAAAACGAAACAATCTCCTATT
9VSP AAAGGAATGCTGATAAAAAATGGCAAAAACAAAAAGCAAAAACGAAACAATCTCCTATT
TIGR4 AAAGGGATGCTGATAAAAA-TGGTAAAAACAAAAAGCAAAAACGAAATAATCTCCTATT
23FTW AAAGGGATGCTGATAAAAA-TGGTAAAAACAAAAAGCAAAAACGAAATAATCTCCTATT

14CSR AGGAGTGGTATTTTTTCATTGGAATGGCGGTAATGGCGTATCCGCTGGTGTCTCGCTTGTA
670 AGGAGTGGTATTTTTTCATTGGAATGGCGGTAATGGCGTATCCGCTGGTGTCTCGCTTGTA
6BF AGGAGTGGTATTTTTTCATTGGAATGGCGGTAATGGCGTATCCGCTGGTGTCTCGCTTGTA
6BSP AGGAGTGGTATTTTTTCATTGGAATGGCGGTAATGGCGTATCCGCTGGTGTCTCGCTTGTA
19AH AGGAGTGGTATTTTTTCATTGGAATGGCGGTAATGGCGTATCCGCTGGTGTCTCGCTTGTA
23FPO AGGAGTGGTATTTTTTCATTGGAATGGCGGTAATGGCGTATCCGCTGGTGTCTCGCTTGTA
19FTW AGGAGTGGTATTTTTTCATTGGAATGGCGGTAATGGCGTATCCGCTGGTGTCTCGCTTGTA
9VSP AGGAGTGGTATTTTTTCATTGGAATGGCGGTAATGGCGTATCCGCTGGTGTCTCGCTTGTA
TIGR4 AGGAGTGGTATTTTTTCATTGGAATGGCGGTAATGGCGTATCCGCTGGTGTCTCGCTTGTA
23FTW AGGAGTGGTATTTTTTCATTGGAATGGCGGTAATGGCGTATCCGCTGGTGTCTCGCTTGTA

14CSR TTATCGAGTGAATCAAATCAACAAATGCTGACTTTGATAAGGAAAAAGCAACGTTGGA
670 TTATCGAGTGAATCAAATCAACAAATGCTGACTTTGATAAGGAAAAAGCAACGTTGGA
6BF TTATCGAGTGAATCAAATCAACAAATGCTGACTTTGATAAGGAAAAAGCAACGTTGGA
6BSP TTATCGAGTGAATCAAATCAACAAATGCTGACTTTGATAAGGAAAAAGCAACGTTGGA
19AH TTATCGAGTGAATCAAATCAACAAATGCTGACTTTGATAAGGAAAAAGCAACGTTGGA
23FPO TTATCGAGTGAATCAAATCAACAAATGCTGACTTTGATAAGGAAAAAGCAACGTTGGA
19FTW TTATCGAGTGAATCAAATCAACAAATGCTGACTTTGATAAGGAAAAAGCAACGTTGGA
9VSP TTATCGAGTGAATCAAATCAACAAATGCTGACTTTGATAAGGAAAAAGCAACGTTGGA
TIGR4 TTATCGAGTGAATCAAATCAACAAATGCTGACTTTGATAAGGAAAAAGCAACGTTGGA
23FTW TTATCGAGTGAATCAAATCAACAAATGCTGACTTTGATAAGGAAAAAGCAACGTTGGA

Figure 196AD

PCT/US2005/27239 423/487

14CSR TGAGGCTGACATTGATGAACGAATGAAATTTGGCACAAAGCCTTCAATGACTCTTTGAATAA
670 TGAGGCTGACATTGATGAACGAATGAAATTTGGCACAAAGCCTTCAATGACTCTTTGAATAA
6BF TGAGGCTGACATTGATGAACGAATGAAATTTGGCACAAAGCCTTCAATGACTCTTTGAATAA
6BSP TGAGGCTGACATTGATGAACGAATGAAATTTGGCACAAAGCCTTCAATGACTCTTTGAATAA
19AH TGAGGCTGACATTGATGAACGAATGAAATTTGGCACAAAGCCTTCAATGACTCTTTGAATAA
23FPO TGAGGCTGACATTGATGAACGAATGAAATTTGGCACAAAGCCTTCAATGACTCTTTGAATAA
19FTW TGAGGCTGACATTGATGAACGAATGAAATTTGGCACAAAGCCTTCAATGACTCTTTGAATAA
9VSP TGAGGCTGACATTGATGAACGAATGAAATTTGGCACAAAGCCTTCAATGACTCTTTGAATAA
TIGR4 TGAGGCTGACATTGATGAACGAATGAAATTTGGCACAAAGCCTTCAATGACTCTTTGAATAA
23FTW TGAGGCTGACATTGATGAACGAATGAAATTTGGCACAAAGCCTTCAATGACTCTTTGAATAA

14CSR TGTAGTGAGTGGCGATCCTTGGTCGGAAGAAATGAAGAAAAAGGGCGAGCAGAGTATGC
670 TGTAGTGAGTGGCGATCCTTGGTCGGAAGAAATGAAGAAAAAGGGCGAGCAGAGTATGC
6BF TGTAGTGAGTGGCGATCCTTGGTCGGAAGAAATGAAGAAAAAGGGCGAGCAGAGTATGC
6BSP TGTAGTGAGTGGCGATCCTTGGTCGGAAGAAATGAAGAAAAAGGGCGAGCAGAGTATGC
19AH TGTAGTGAGTGGCGATCCTTGGTCGGAAGAAATGAAGAAAAAGGGCGAGCAGAGTATGC
23FPO TGTAGTGAGTGGCGATCCTTGGTCGGAAGAAATGAAGAAAAAGGGCGAGCAGAGTATGC
19FTW TGTAGTGAGTGGCGATCCTTGGTCGGAAGAAATGAAGAAAAAGGGCGAGCAGAGTATGC
9VSP TGTAGTGAGTGGCGATCCTTGGTCGGAAGAAATGAAGAAAAAGGGCGAGCAGAGTATGC
TIGR4 TGTAGTGAGTGGCGATCCTTGGTCGGAAGAAATGAAGAAAAAGGGCGAGCAGAGTATGC
23FTW TGTAGTGAGTGGCGATCCTTGGTCGGAAGAAATGAAGAAAAAGGGCGAGCAGAGTATGC

14CSR ACGTATGTTAGAAATCCATGAGCGGATGGGGCATGTGGAAATCCCCGTTATTTGACGTGGA
670 ACGTATGTTAGAAATCCATGAGCGGATGGGGCATGTGGAAATCCCCGTTATTTGACGTGGA
6BF ACGTATGTTAGAAATCCATGAGCGGATGGGGCATGTGGAAATCCCCGTTATTTGACGTGGA
6BSP ACGTATGTTAGAAATCCATGAGCGGATGGGGCATGTGGAAATCCCCGTTATTTGACGTGGA
19AH ACGTATGTTAGAAATCCATGAGCGGATGGGGCATGTGGAAATCCCCGTTATTTGACGTGGA
23FPO ACGCATGTTAGAAATCCATGAGCGGATGGGGCATGTGGAAATCCCTGCTATTTGATGTAGA
19FTW ACGCATGTTAGAAATCCATGAGCGGATGGGGCATGTGGAAATCCCTGCTATTTGATGTAGA
9VSP ACGCATGTTAGAAATCCATGAGCGGATGGGGCATGTGGAAATCCCTGCTATTTGATGTAGA
TIGR4 ACGTATGTTAGAAATCCATGAGCGGATGGGGCATGTGGAAATCCCCGTTATTTGACGTGGA
23FTW ACGTATGTTAGAAATCCATGAGCGGATGGGGCATGTGGAAATCCCCGTTATTTGACGTGGA
*** ***** * ***** ** **

14CSR TTTGCCGGTTTATGCTGGTACTGCTGAAGAGGTATTGCAGCAAGGGGCTGGGCATCTAGA
670 TTTGCCGGTTTATGCTGGTACTGCTGAAGAGGTATTGCAGCAAGGGGCTGGGCATCTAGA
6BF TTTGCCGGTTTATGCTGGTACTGCTGAAGAGGTATTGCAGCAAGGGGCTGGGCATCTAGA
6BSP TTTGCCGGTTTATGCTGGTACTGCTGAAGAGGTATTGCAGCAAGGGGCTGGGCATCTAGA
19AH TTTGCCGGTTTATGCTGGTACTGCTGAAGAGGTATTGCAGCAAGGGGCTGGGCATCTAGA
23FPO TTTGCCGGTTTATGCTGGTACTGCTGAAGAGGTATTGCAGCAAGGGGCTGGGCATCTAGA
19FTW TTTGCCGGTTTATGCTGGTACTGCTGAAGAGGTATTGCAGCAAGGGGCTGGGCATCTAGA
9VSP TTTGCCGGTTTATGCTGGTACTGCTGAAGAGGTATTGCAGCAAGGGGCTGGGCATCTAGA
TIGR4 TTTGCCGGTTTATGCTGGTACTGCTGAAGAGGTATTGCAGCAAGGGGCTGGGCATCTAGA
23FTW TTTGCCGGTTTATGCTGGTACTGCTGAAGAGGTATTGCAGCAAGGGGCTGGGCATCTAGA
***** ** *****

14CSR GGGAACTTCTCTGCCGATCGGAGGCAATTCGACCCATGCGGTGATTACGGCACATACAGG
670 GGGAACTTCTCTGCCGATCGGAGGCAATTCGACCCATGCGGTGATTACGGCACATACAGG
6BF GGGAACTTCTCTGCCGATCGGAGGCAATTCGACCCATGCGGTGATTACGGCACATACAGG
6BSP GGGAACTTCTCTGCCGATCGGAGGCAATTCGACCCATGCGGTGATTACGGCACATACAGG
19AH GGGAACTTCTCTGCCGATCGGAGGCAATTCGACCCATGCGGTGATTACGGCACATACAGG
23FPO GGGAACTTCTCTACCGATCGGAGGCAATTCGACCCATGCGGTGATTACGGCACATACAGG
19FTW GGGAACTTCTCTACCGATCGGAGGCAATTCGACCCATGCGGTGATTACGGCACATACAGG
9VSP GGGAACTTCTCTACCGATCGGAGGCAATTCGACCCATGCGGTGATTACGGCACATACAGG
TIGR4 GGGAACTTCTCTGCCGATCGGAGGCAATTCGACCCATGCGGTGATTACGGCACATACAGG
23FTW GGGAACTTCTCTGCCGATCGGAGGCAATTCGACCCATGCGGTGATTACGGCACATACAGG

Figure 196AE

14CSR TTTGCCAACAGCTAAGATGTTTACGGATTGACCAAACCTTAAAGTTGGGGATAAGTTTTA
670 TTTGCCAACAGCTAAGATGTTTACGGATTGACCAAACCTTAAAGTTGGGGATAAGTTTTA
6BF TTTGCCAACAGCTAAGATGTTTACGGATTGACCAAACCTTAAAGTTGGGGATAAGTTTTA
6BSP TTTGCCAACAGCTAAGATGTTTACGGATTGACCAAACCTTAAAGTTGGGGATAAGTTTTA
19AH TTTGCCAACAGCGAAGATGTTTACGGATTGACCAAACCTTAAAGTTGGGGATAAGTTTTA
23FPO TTTGCCAACGGCTAAGATGTTTACGGATTGACCAAACCTTAAAGTTGGGGATAAGTTTTA
19FTW TTTGCCAACGGCTAAGATGTTTACGGATTGACCAAACCTTAAAGTTGGGGATAAGTTTTA
9VSP TTTGCCAACGGCTAAGATGTTTACGGATTGACCAAACCTTAAAGTTGGGGATAAGTTTTA
TIGR4 TTTGCCAACAGCTAAGATGTTTACGGATTGACCAAACCTTAAAGTTGGGGATAAGTTTTA
23FTW TTTGCCAACAGCTAAGATGTTTACGGATTGACCAAACCTTAAAGTTGGGGATAAGTTTTA
***** **

14CSR TGTGCACAATATCAAGGAAGTGATGGCCTATCAAGTGGATCAAGTAAAGGTGATGAGCC
670 TGTGCACAATATCAAGGAAGTGATGGCCTATCAAGTGGATCAAGTAAAGGTGATGAGCC
6BF TGTGCACAATATCAAGGAAGTGATGGCCTATCAAGTGGATCAAGTAAAGGTGATGAGCC
6BSP TGTGCACAATATCAAGGAAGTGATGGCCTATCAAGTGGATCAAGTAAAGGTGATGAGCC
19AH TGTGCACAATATCAAGGAAGTGATGGCCTATCAAGTGGATCAAGTAAAGGTGATGAGCC
23FPO TGTGCACAATATCAAGGAAGTGATGGCCTATCAAGTGGATCAAGTAAAGGTGATGAGCC
19FTW TGTGCACAATATCAAGGAAGTGATGGCCTATCAAGTGGATCAAGTAAAGGTGATGAGCC
9VSP TGTGCACAATATCAAGGAAGTGATGGCCTATCAAGTGGATCAAGTAAAGGTGATGAGCC
TIGR4 TGTGCACAATATCAAGGAAGTGATGGCCTATCAAGTGGATCAAGTAAAGGTGATGAGCC
23FTW TGTGCACAATATCAAGGAAGTGATGGCCTATCAAGTGGATCAAGTAAAGGTGATGAGCC
***** **

14CSR GACGAACTTTGATGATTTATTGATTGTACCAGGTCATGATTATGTGACCTTGCTGACTTG
670 GACGAACTTTGATGATTTATTGATTGTACCAGGTCATGATTATGTGACCTTGCTGACTTG
6BF GACGAACTTTGATGATTTATTGATTGTACCAGGTCATGATTATGTGACCTTGCTGACTTG
6BSP GACGAACTTTGATGATTTATTGATTGTACCAGGTCATGATTATGTGACCTTGCTGACTTG
19AH GACGAACTTTGATGATTTATTGATTGTACCAGGTCATGATTATGTGACCTTGCTGACTTG
23FPO GACGAACTTTGATGATTTATTGATTGTACCAGGTCATGATTATGTGACCTTGCTGACTTG
19FTW GACGAACTTTGATGATTTATTGATTGTACCAGGTCATGATTATGTGACCTTGCTGACTTG
9VSP GACGAACTTTGATGATTTATTGATTGTACCAGGTCATGATTATGTGACCTTGCTGACTTG
TIGR4 GACGAACTTTGATGATTTATTGATTGTACCAGGTCATGATTATGTGACCTTGCTGACTTG
23FTW GACGAACTTTGATGATTTATTGATTGTACCAGGTCATGATTATGTGACCTTGCTGACTTG
***** **

14CSR TACGCCATACATGATCAATACCCATCGTCTATTGGTTCGGGGGCATCGGATACCGTACGT
670 TACGCCATACATGATCAATACCCATCGTCTATTGGTTCGGGGGCATCGGATACCGTACGT
6BF TACGCCATACATGATCAATACCCATCGTCTATTGGTTCGGGGGCATCGGATACCGTACGT
6BSP TACGCCATACATGATCAATACCCATCGTCTATTGGTTCGGGGGCATCGGATACCGTACGT
19AH TACGCCATACATGATCAATACCCATCGTCTATTGGTTCGGGGGCATCGGATACCGTACGT
23FPO TACGCCATACATGATCAATACCCATCGTCTATTGGTTCGGGGGCATCGGATACCGTACGT
19FTW TACGCCATACATGATCAATACCCATCGTCTATTGGTTCGGGGGCATCGGATACCGTACGT
9VSP TACGCCATACATGATCAATACCCATCGTCTATTGGTTCGGGGGCATCGGATACCGTACGT
TIGR4 TACGCCATACATGATCAATACCCATCGTCTATTGGTTCGGGGGCATCGGATACCGTACGT
23FTW TACGCCATACATGATCAATACCCATCGTCTATTGGTTCGGGGGCATCGGATACCGTACGT
***** **

14CSR AGCAGAGGTTGAGGAAGAATTTATTGCAGCAAACAACTCAGTCATCTCTATCGCTACCT
670 AGCAGAGGTTGAGGAAGAATTTATTGCAGCAAACAACTCAGTCATCTCTATCGCTACCT
6BF AGCAGAGGTTGAGGAAGAATTTATTGCAGCAAACAACTCAGTCATCTCTATCGCTACCT
6BSP AGCAGAGGTTGAGGAAGAATTTATTGCAGCAAACAACTCAGTCATCTCTATCGCTACCT
19AH AGCAGAGGTTGAGGAAGAATTTATTGCAGCAAACAACTCAGTCATCTCTATCGCTACCT
23FPO AGCAGAGGTTGAGGAAGAATTTATTGCAGCAAACAACTCAGTCATCTCTATCGCTACCT
19FTW AGCAGAGGTTGAGGAAGAATTTATTGCAGCAAACAACTCAGTCATCTCTATCGCTACCT
9VSP AGCAGAGGTTGAGGAAGAATTTATTGCAGCAAACAACTCAGTCATCTCTATCGCTACCT
TIGR4 AGCAGAGGTTGAGGAAGAATTTATTGCAGCAAACAACTCAGTCATCTCTATCGCTACCT
23FTW AGCAGAGGTTGAGGAAGAATTTATTGCAGCAAACAACTCAGTCATCTCTATCGCTACCT
***** **

Figure 196AF

14CSR GTTTTATGTGGCAGTTGGTTTGATTGTGATTCCTTTATGGATTATTTCGACGCTTGCGCAA
670 GTTTTATGTGGCAGTTGGTTTGATTGTGATTCCTTTATGGATTATTTCGACGCTTGCGCAA
6BF GTTTTATGTGGCAGTTGGTTTGATTGTGATTCCTTTATGGATTATTTCGACGCTTGCGCAA
6BSP GTTTTATGTGGCAGTTGGTTTGATTGTGATTCCTTTATGGATTATTTCGACGCTTGCGCAA
19AH GTTTTATGTGGCAGTTGGTTTGATTGTGATTCCTTTATGGATTATTTCGACGCTTGCGCAA
23FPO GTTTTATGTGGCAGTTGGTTTGATTGTGATTCCTTTATGGATTATTTCGACGCTTGCGCAA
19FTW GTTTTATGTGGCAGTTGGTTTGATTGTGATTCCTTTATGGATTATTTCGACGCTTGCGCAA
9VSP GTTTTATGTGGCAGTTGGTTTGATTGTGATTCCTTTATGGATTATTTCGACGCTTGCGCAA
TIGR4 GTTTTATGTGGCAGTTGGTTTGATTGTGATTCCTTTATGGATTATTTCGACGCTTGCGCAA
23FTW GTTTTATGTGGCAGTTGGTTTGATTGTGATTCCTTTATGGATTATTTCGACGCTTGCGCAA

14CSR GAAGAAAAACAACCGGAAAAGGCTTTGAAGGCGCTGAAAGCAGCAAGGAAGGAAGTGAA
670 GAAGAAAAACAACCGGAAAAGGCTTTGAAGGCGCTGAAAGCAGCAAGGAAGGAAGTGAA
6BF GAAGAAAAACAACCGGAAAAGGCTTTGAAGGCGCTGAAAGCAGCAAGGAAGGAAGTGAA
6BSP GAAGAAAAACAACCGGAAAAGGCTTTGAAGGCGCTGAAAGCAGCAAGGAAGGAAGTGAA
19AH GAAGAAAAACAACCGGAAAAGGCTTTGAAGGCGCTGAAAGCAGCAAGGAAGGAAGTGAA
23FPO GAAGAAACGGCAATCAGAAAAGAGCTTTGAAAGCATTGAAGGAAGCTACTAAGGAAGTGAA
19FTW GAAGAAACGGCAATCAGAAAAGAGCTTTGAAAGCATTGAAGGAAGCTACTAAGGAAGTGAA
9VSP GAAGAAACGGCAATCAGAAAAGAGCTTTGAAAGCATTGAAGGAAGCTACTAAGGAAGTGAA
TIGR4 GAAGAAAAACAACCGGAAAAGGCTTTGAAGGCGCTGAAAGCAGCAAGGAAGGAAGTGAA
23FTW GAAGAAAAACAACCGGAAAAGGCTTTGAAGGCGCTGAAAGCAGCAAGGAAGGAAGTGAA
***** ** * **** ***** ** ***** * ** * *****

14CSR GGTGGAGGATGGACAACAGTAGACGTTACGAAAAAAGGCCACAAAAAGAAGAACATC
670 GGTGGAGGATGGACAACAGTAGACGTTACGAAAAAAGGCCACAAAAAGAAGAACATC
6BF GGTGGAGGATGGACAACAGTAGACGTTACGAAAAAAGGCCACAAAAAGAAGAACATC
6BSP GGTGGAGGATGGACAACAGTAGACGTTACGAAAAAAGGCCACAAAAAGAAGAACATC
19AH GGTGGAGGATGGACAACAGTAGACGTTACGAAAAAAGGCCACAAAAAGAAGAACATC
23FPO GGTAGAGGATGAGTAAGAGTAGATATTACGGAAAAAGAGCGTGAAAAAGAAGAAAAATC
19FTW GGTAGAGGATGAGTAAGAGTAGATATTACGGAAAAAGAGCGTGAAAAAGAAGAAAAATC
9VSP GGTAGAGGATGAGTAAGAGTAGATATTACGGAAAAAGAGCGTGAAAAAGAAGAAAAATC
TIGR4 GGTGGAGGATGGACAACAGTAGACGTTACGAAAAAAGGCCACAAAAAGAAGAACATC
23FTW GGTGGAGGATGGACAACAGTAGACGTTACGAAAAAAGGCCACAAAAAGAAGAACATC
*** ***** ** ***** ***** ***** ** *****

14CSR CGCTGATCCTTCTTCTGATTTTCTTAGTAGGATTCGCCGTTGCGATATATCCATTGGTGT
670 CGCTGATCCTTCTTCTGATTTTCTTAGTAGGATTCGCCGTTGCGATATATCCATTGGTGT
6BF CGCTGATCCTTCTTCTGATTTTCTTAGTAGGATTCGCCGTTGCGATATATCCATTGGTGT
6BSP CGCTGATCCTTCTTCTGATTTTCTTAGTAGGATTCGCCGTTGCGATATATCCATTGGTGT
19AH CGCTGATCCTTCTTCTGATTTTCTTAGTAGGATTCGCCGTTGCGATATATCCATTGGTGT
23FPO CGTTCATTCTTCTTCTGATTTTCTTAGTAGGATTCGCCGTTGCGATATATCCATTGGTGT
19FTW CGTTCATTCTTCTTCTGATTTTCTTAGTAGGATTCGCCGTTGCGATATATCCATTGGTGT
9VSP CGTTCATTCTTCTTCTGATTTTCTTAGTAGGATTCGCCGTTGCGATATATCCATTGGTGT
TIGR4 CGCTGATCCTTCTTCTGATTTTCTTAGTAGGATTCGCCGTTGCGATATATCCATTGGTGT
23FTW CGCTGATCCTTCTTCTGATTTTCTTAGTAGGATTCGCCGTTGCGATATATCCATTGGTGT
** * ** ***** ** * ** * ***** ***** *****

14CSR CTCGTTATTATTATCGTATTGAGTCAAACGAGGTTATTAAGAGTTTGATGAGACGGTTT
670 CTCGTTATTATTATCGTATTGAGTCAAACGAGGTTATTAAGAGTTTGATGAGACGGTTT
6BF CTCGTTATTATTATCGTATTGAGTCAAACGAGGTTATTAAGAGTTTGATGAGACGGTTT
6BSP CTCGTTATTATTATCGTATTGAGTCAAACGAGGTTATTAAGAGTTTGATGAGACGGTTT
19AH CTCGTTATTATTATCGTATTGAGTCAAACGAGGTTATTAAGAGTTTGATGAGACGGTTT
23FPO CTCGTTATTATTATCGTATTGAGTCAAACGAGGTTATTAAGAGTTTGATGAGACGGTTT
19FTW CTCGTTATTATTATCGTATTGAGTCAAACGAGGTTATTAAGAGTTTGATGAGACGGTTT
9VSP CTCGTTATTATTATCGTATTGAGTCAAACGAGGTTATTAAGAGTTTGATGAGACGGTTT
TIGR4 CTCGTTATTATTATCGTATTGAGTCAAACGAGGTTATTAAGAGTTTGATGAGACGGTTT
23FTW CTCGTTATTATTATCGTATTGAGTCAAACGAGGTTATTAAGAGTTTGATGAGACGGTTT

14CSR CCCAGATGGATAAAGGCAGAACTTGAGGAGCGTTGGCGCTTGGCTCAAGCCTTCAATGCGA
670 CCCAGATGGATAAAGGCAGAACTTGAGGAGCGTTGGCGCTTGGCTCAAGCCTTCAATGCGA
6BF CCCAGATGGATAAAGGCAGAACTTGAGGAGCGTTGGCGCTTGGCTCAAGCCTTCAATGCGA
6BSP CCCAGATGGATAAAGGCAGAACTTGAGGAGCGTTGGCGCTTGGCTCAAGCCTTCAATGCGA
19AH CCCAGATGGATAAAGGCAGAACTTGAGGAGCGTTGGCGCTTGGCTCAAGCCTTCAATGCGA
23FPO CCCAGATGGATAAAGGCAGAACTTGAGGAGCGTTGGCGCTTGGCTCAAGCCTTCAATGCGA
19FTW CCCAGATGGATAAAGGCAGAACTTGAGGAGCGTTGGCGCTTGGCTCAAGCCTTCAATGCGA
9VSP CCCAGATGGATAAAGGCAGAACTTGAGGAGCGTTGGCGCTTGGCTCAAGCCTTCAATGCGA
TIGR4 CCCAGATGGATAAAGGCAGAACTTGAGGAGCGTTGGCGCTTGGCTCAAGCCTTCAATGCGA
23FTW CCCAGATGGATAAAGGCAGAACTTGAGGAGCGTTGGCGCTTGGCTCAAGCCTTCAATGCGA

14CSR CCTTGAACCATCTGAAATTCCTGATCCTTTTACAGAGCAAGAGAAAAAGAAAGGCGTCT
670 CCTTGAACCATCTGAAATTCCTGATCCTTTTACAGAGCAAGAGAAAAAGAAAGGCGTCT
6BF CCTTGAACCATCTGAAATTCCTGATCCTTTTACAGAGCAAGAGAAAAAGAAAGGCGTCT
6BSP CCTTGAACCATCTGAAATTCCTGATCCTTTTACAGAGCAAGAGAAAAAGAAAGGCGTCT
19AH CCTTGAACCATCTGAAATTCCTGATCCTTTTACAGAGCAAGAGAAAAAGAAAGGCGTCT
23FPO CCTTGAACCATCTGAAATTCCTGATCCTTTTACAGAGCAAGAGAAAAAGAAAGGCGTCT
19FTW CCTTGAACCATCTGAAATCCTCGATCCTTTTACAGATCAGGAAAAGAACAGGGAGTTT
9VSP CCTTGAACCATCTGAAATTCCTGATCCTTTTACAGAGCAAGAGAAAAAGAAAGGCGTCT
TIGR4 CCTTGAACCATCTGAAATTCCTGATCCTTTTACAGAGCAAGAGAAAAAGAAAGGCGTCT
23FTW CCTTGAACCATCTGAAATTCCTGATCCTTTTACAGAGCAAGAGAAAAAGAAAGGCGTCT

14CSR CAGAATATGCCAATATGCTAAAGGTCCATGAGCGGATTGGCTATGTGGAAATTCCTGCGA
670 CAGAATATGCCAATATGCTAAAGGTCCATGAGCGGATTGGCTATGTGGAAATTCCTGCGA
6BF CAGAATATGCCAATATGCTAAAGGTCCATGAGCGGATTGGCTATGTGGAAATTCCTGCGA
6BSP CAGAATATGCCAATATGCTAAAGGTCCATGAGCGGATTGGCTATGTGGAAATTCCTGCGA
19AH CAGAATATGCCAATATGCTAAAGGTCCATGAGCGGATTGGCTATGTGGAAATTCCTGCGA
23FPO CAGAATATGCCAATATGCTAAAGGTCCATGAGCGGATTGGCTATGTGGAAATTCCTGCGA
19FTW CAGAATATGCCAATATGCTAAAGGTCCATGAGCGGATTGGCTATGTGGAAATTCCTGCGA
9VSP CAGAATATGCCAATATGCTAAAGGTCCATGAGCGGATTGGCTATGTGGAAATTCCTGCGA
TIGR4 CAGAATATGCCAATATGCTAAAGGTCCATGAGCGGATTGGCTATGTGGAAATTCCTGCGA
23FTW CAGAATATGCCAATATGCTAAAGGTCCATGAGCGGATTGGCTATGTGGAAATTCCTGCGA

14CSR TTGATCAGGAAATTCGGATGTATGTCGGAACGAGTGAGGAAATTCCTCAGAAGGGCGCAG
670 TTGATCAGGAAATTCGGATGTATGTCGGAACGAGTGAGGAAATTCCTCAGAAGGGCGCAG
6BF TTGATCAGGAAATTCGGATGTATGTCGGAACGAGTGAGGAAATTCCTCAGAAGGGCGCAG
6BSP TTGATCAGGAAATTCGGATGTATGTCGGAACGAGTGAGGAAATTCCTCAGAAGGGCGCAG
19AH TTGATCAGGAAATTCGGATGTATGTCGGAACGAGTGAGGAAATTCCTCAGAAGGGCGCAG
23FPO TTGATCAGGAAATTCGGATGTATGTCGGAACGAGTGAGGAAATTCCTCAGAAGGGCGCAG
19FTW TTGATCAGGAAATTCGGATGTATGTCGGAACGAGTGAGGAAATTCCTCAGAAGGGCGCAG
9VSP TTGATCAGGAAATTCGGATGTATGTCGGAACGAGTGAGGAAATTCCTCAGAAGGGCGCAG
TIGR4 TTGATCAGGAAATTCGGATGTATGTCGGAACGAGTGAGGAAATTCCTCAGAAGGGCGCAG
23FTW TTGATCAGGAAATTCGGATGTATGTCGGAACGAGTGAGGAAATTCCTCAGAAGGGCGCAG

14CSR GATTGCTAGAGGGAGCTTCGTTACCGGTTGGTGGTGAAAATACCCACACAGTTGTCACTG
670 GATTGCTAGAGGGAGCTTCGTTACCGGTTGGTGGTGAAAATACCCACACAGTTGTCACTG
6BF GATTGCTAGAGGGAGCTTCGTTACCGGTTGGTGGTGAAAATACCCACACAGTTGTCACTG
6BSP GATTGCTAGAGGGAGCTTCGTTACCGGTTGGTGGTGAAAATACCCACACAGTTGTCACTG
19AH GATTGCTAGAGGGAGCTTCGTTACCGGTTGGTGGTGAAAATACCCACACAGTTGTCACTG
23FPO GATTGCTAGAGGGAGCTTCGTTACCGGTTGGTGGTGAAAATACCCACACAGTTGTCACTG
19FTW GGCTGTTAGAAGGGGCTTCGCTGCCTGTTGGAGGTGAAAATACCCACACAGTTGTCACTG
9VSP GATTGCTAGAGGGAGCTTCGTTACCGGTTGGTGGTGAAAATACCCACACAGTTGTCACTG
TIGR4 GGCTGTTAGAAGGGGCTTCGCTGCCTGTTGGAGGTGAAAATACCCACACAGTTGTCACTG
23FTW GATTGCTAGAGGGAGCTTCGTTACCGGTTGGTGGTGAAAATACCCACACAGTTGTCACTG
* *

PCT/US05/27239 427/487

14CSR CTCATAGAGGATTACCGACGGCAGAAGCTGTTTAGTCAATTGGATAAGATGAAAAAGGGG
670 CTCATAGAGGATTACCGACGGCAGAAGCTGTTTAGTCAATTGGATAAGATGAAAAAGGGG
6BF CTCATAGAGGATTACCGACGGCAGAAGCTGTTTAGTCAATTGGATAAGATGAAAAAGGGG
6BSP CTCATAGAGGATTACCGACGGCAGAAGCTGTTTAGTCAATTGGATAAGATGAAAAAGGGG
19AH CTCATAGAGGATTACCGACGGCAGAAGCTGTTTAGTCAATTGGATAAGATGAAAAAGGGG
23FPO CTCATAGAGGATTACCGACGGCAGAAGCTGTTTAGTCAATTGGATAAGATGAAAAAGGGG
19FTW CTCACAGAGGATTGCCAACGGCAGAATTGTTTCACTCAATTGGATAAGATGAAAAAGGGG
9VSP CTCATAGAGGATTACCGACGGCAGAAGCTGTTTAGTCAATTGGATAAGATGAAAAAGGGG
TIGR4 CTCACAGAGGATTGCCAACGGCAGAATTGTTTCACTCAATTGGATAAGATGAAAAAGGGG
23FTW CTCATAGAGGATTACCGACGGCAGAAGCTGTTTAGTCAATTGGATAAGATGAAAAAGGGG
**** ***** ** ***** **** ***** ***** ***** *****

14CSR ATGTCCTTTTATCTTCACGTTTTAGACCAGGTGTTGGCCTACCAAGTGGATCAGATTTTGA
670 ATGTCCTTTTATCTTCACGTTTTAGACCAGGTGTTGGCCTACCAAGTGGATCAGATTTTGA
6BF ATGTCCTTTTATCTTCACGTTTTAGACCAGGTGTTGGCCTACCAAGTGGATCAGATTTTGA
6BSP ATGTCCTTTTATCTTCACGTTTTAGACCAGGTGTTGGCCTACCAAGTGGATCAGATTTTGA
19AH ATGTCCTTTTATCTTCACGTTTTAGACCAGGTGTTGGCCTACCAAGTGGATCAGATTTTGA
23FPO ATATCTTTTATCTTCACGTTTTAGATCAGGTGTTGGCCTACCAAGTGGATCAGATAGTGA
19FTW ATATCTTTTATCTTCACGTTTTAGACCAGGTGTTGGCCTACCAAGTGGATCAGATAGTGA
9VSP ATATCTTTTATCTTCACGTTTTAGATCAGGTGTTGGCCTACCAAGTGGATCAGATAGTGA
TIGR4 ATATCTTTTATCTTCACGTTTTAGATCAGGTGTTGGCCTACCAAGTGGATCAGATAGTGA
23FTW ATGTCCTTTTATCTTCACGTTTTAGACCAGGTGTTGGCCTACCAAGTGGATCAGATTTTGA
** ***** ***** ***** ***** ***** ***** *****

14CSR CGGTTGAGCCAAATGACTTTGAGCCTGTCTTGATTCAACATGGGGAAGATTATGCGACCT
670 CGGTTGAGCCAAATGACTTTGAGCCTGTCTTGATTCAACATGGGGAAGATTATGCGACCT
6BF CGGTTGAGCCAAATGACTTTGAGCCTGTCTTGATTCAACATGGGGAAGATTATGCGACCT
6BSP CGGTTGAGCCAAATGACTTTGAGCCTGTCTTGATTCAACATGGGGAAGATTATGCGACCT
19AH CGGTTGAGCCAAATGACTTTGAGCCTGTCTTGATTCAACATGGGGAAGATTATGCGACCT
23FPO CGGTTGAGCCGAATGACTTTGAGCCTGTCTTGATTCAACATGGGGAAGATTATGCGACCT
19FTW CGGTTGAGCCGAATGACTTTGAGCCTGTCTTGATTCAACATGGGGAAGATTATGCGACTT
9VSP CGGTTGAGCCGAATGACTTTGAGCCTGTCTTGATTCAACATGGGGAAGATTATGCGACCT
TIGR4 CGGTTGAGCCGAATGACTTTGAGCCTGTCTTGATTCAACATGGGGAAGATTATGCGACCT
23FTW CGGTTGAGCCAAATGACTTTGAGCCTGTCTTGATTCAACATGGGGAAGATTATGCGACCT
**** ***** ***** ***** ***** ***** ***** *****

14CSR TGTTGACCTGTACACCGTATATGATTAACAGTCATCGTCTGTTGGTACGTGGGAAGCGGA
670 TGTTGACCTGTACACCGTATATGATTAACAGTCATCGTCTGTTGGTACGTGGGAAGCGGA
6BF TGTTGACCTGTACACCGTATATGATTAACAGTCATCGTCTGTTGGTACGTGGGAAGCGGA
6BSP TGTTGACCTGTACACCGTATATGATTAACAGTCATCGTCTGTTGGTACGTGGGAAGCGGA
19AH TGTTGACCTGTACACCGTATATGATTAACAGTCATCGTCTGTTGGTACGTGGGAAGCGGA
23FPO TGTTGACTTGTACACCGTATATGATTAACAGTCATCGTCTGTTGGTACGTGGGAAGCGGA
19FTW TACTGACTTGTACGCCATACATGATTAACAGCCACCGTTTGTGGTACGTGGGAAGCGGA
9VSP TGTTGACTTGTACACCGTATATGATTAACAGTCATCGTCTGTTGGTACGTGGGAAGCGGA
TIGR4 TGTTGACTTGTACACCGTATATGATTAACAGTCATCGTCTGTTGGTACGTGGGAAGCGGA
23FTW TGTTGACCTGTACACCGTATATGATTAACAGTCATCGTCTGTTGGTACGTGGGAAGCGGA
* **** ***** ** ** ***** ***** ***** ***** *****

14CSR TTCCGTATACGGCACCAATTGCAGAGCGAAATCGAGCGGTGAGAGAGCGTGGGCAATTCT
670 TTCCGTATACGGCACCAATTGCAGAGCGAAATCGAGCGGTGAGAGAGCGTGGGCAATTCT
6BF TTCCGTATACGGCACCAATTGCAGAGCGAAATCGAGCGGTGAGAGAGCGTGGGCAATTCT
6BSP TTCCGTATACGGCACCAATTGCAGAGCGAAATCGAGCGGTGAGAGAGCGTGGGCAATTCT
19AH TTCCGTATACGGCACCAATTGCAGAGCGAAATCGAGCGGTGAGAGAGCGTGGGCAATTCT
23FPO TTCCGTATACGGCACCAATTGCAGAGCGAAATCGAGCGGTGAGAGAGCGTGGGCAATTCT
19FTW TTCCATATACAGCGCGGATTGCTGAGCGGAATCGAGCGGTGAGAGAGCGTGGGCAATTCT
9VSP TTCCGTATACGGCACCAATTGCAGAGCGAAATCGAGCGGTGAGAGAGCGTGGGCAATTCT
TIGR4 TTCCGTATACGGCACCAATTGCAGAGCGAAATCGAGCGGTGAGAGAGCGTGGGCAATTCT
23FTW TTCCGTATACGGCACCAATTGCAGAGCGAAATCGAGCGGTGAGAGAGCGTGGGCAATTCT
**** ***** ** ** ***** ***** ***** ***** *****

Figure 196I

14CSR GTTTGTGGTTATTGCTAGCGGCGTTGGTTATGATTCTGGTATTGAGTTACGGGGTGTATC
670 GTTTGTGGTTATTGCTAGCGGCGTTGGTTATGATTCTGGTATTGAGTTACGGGGTGTATC
6BF GTTTGTGGTTATTGCTAGCGGCGTTGGTTATGATTCTGGTATTGAGTTACGGGGTGTATC
6BSP GTTTGTGGTTATTGCTAGCGGCGTTGGTTATGATTCTGGTATTGAGTTACGGGGTGTATC
19AH GTTTGTGGTTATTGCTAGCGGCGTTGGTTATGATTCTGGTATTGAGTTACGGGGTGTATC
23FPO GTTTGTGGTTATTACTAGGAGCGATGGCGGTATCCTTCTCTTGCCTGTATCGCGTGTATC
19FTW GTTTGTGGTTATTACTAGGAGCGATGGCGGTATCCTTCTCTTGCCTGTATCGCGTGTATC
9VSP GTTTGTGGTTATTACTAGGAGCGATGGCGGTATCCTTCTCTTGCCTGTATCGCGTGTATC
TIGR4 GTTTGTGGTTATTACTAGGAGCGATGGCGGTATCCTTCTCTTGCCTGTATCGCGTGTATC
23FTW GTTTGTGGTTATTGCTAGCGGCGTTGGTTATGATTCTGGTATTGAGTTACGGGGTGTATC
***** ** * ** * * ** * ** * ** *

14CSR GTCATCGTCGCATTGTCAAAGGGCTAGAAAAACAATTGGAGGAGCATCATGTCAAAGGCT
670 GTCATCGTCGCATTGTCAAAGGGCTAGAAAAACAATTGGAGGAGCATCATGTCAAAGGCT
6BF GTCATCGTCGCATTGTCAAAGGGCTAGAAAAACAATTGGAGGAGCATCATGTCAAAGGCT
6BSP GTCATCGTCGCATTGTCAAAGGGCTAGAAAAACAATTGGAGGAGCATCATGTCAAAGGCT
19AH GTCATCGTCGCATTGTCAAAGGGCTAGAAAAACAATTGGAGGAGCATCATGTCAAAGGCT
23FPO GTAATCGACGGATTGTCAAAGGACTAGAAAAGCAATTGGAGGGGCGTGTATGCAAGGACT
19FTW GTAATCGACGGATTGTCAAAGGACTAGAAAAGCAATTGGAGGGGCGTGTATGCAAGGACT
9VSP GTAATCGACGGATTGTCAAAGGACTAGAAAAGCAATTGGAGGGGCGTGTATGCAAGGACT
TIGR4 GTAATCGACGGATTGTCAAAGGACTAGAAAAGCAATTGGAGGGGCGTGTATGCAAGGACT
23FTW GTCATCGTCGCATTGTCAAAGGGCTAGAAAAACAATTGGAGGAGCATCATGTCAAAGGCT
** **** * ***** ***** ***** * ***** *

14CSR AAGCTACAGAAATTACTAGGGTATTTGCTGATGCTGGTAGCATTGGTGATTCCCTGTTTAT
670 AAGCTACAGAAATTACTAGGGTATTTGCTGATGCTGGTAGCATTGGTGATTCCCTGTTTAT
6BF AAGCTACAGAAATTACTAGGGTATTTGCTGATGCTGGTAGCATTGGTGATTCCCTGTTTAT
6BSP AAGCTACAGAAATTACTAGGGTATTTGCTGATGCTGGTAGCATTGGTGATTCCCTGTTTAT
19AH AAGCTACAGAAATTACTAGGGTATTTGCTGATGCTGGTAGCATTGGTGATTCCCTGTTTAT
23FPO AAACTACGAGCCTTATTTGGGATACTTGTGATGTTGGTAGCCTGTTTGATTCCCTATTTAT
19FTW AAACTACGAGCCTTATTTGGGATACTTGTGATGTTGGTAGCCTGTTTGATTCCCTATTTAT
9VSP AAACTACGAGCCTTATTTGGGATACTTGTGATGTTGGTAGCCTGTTTGATTCCCTATTTAT
TIGR4 AAACTACGAGCCTTATTTGGGATACTTGTGATGTTGGTAGCCTGTTTGATTCCCTATTTAT
23FTW AAGCTACAGAAATTACTAGGGTATTTGCTGATGCTGGTAGCATTGGTGATTCCCTGTTTAT
** **** * ** * ** * ** * ** * ** * ** * ** *

14CSR TGTTTTGGGCAGATGGTGTACAGTCTTTAGGACAAGTAAAAGGTCATGAGATATTTTCA
670 TGTTTTGGGCAGATGGTGTACAGTCTTTAGGACAAGTAAAAGGTCATGAGATATTTTCA
6BF TGTTTTGGGCAGATGGTGTACAGTCTTTAGGACAAGTAAAAGGTCATGAGATATTTTCA
6BSP TGTTTTGGGCAGATGGTGTACAGTCTTTAGGACAAGTAAAAGGTCATGAGATATTTTCA
19AH TGTTTTGGGCAGATGGTGTACAGTCTTTAGGACAAGTAAAAGGTCATGAGATATTTTCA
23FPO TGTTTTGGACAGATGGTGTGACAGTCTTTGGACAGGTGAAAGGTCATGCTACATTTGTG
19FTW TGTTTTGGACAGATGGTGTGACAGTCTTTGGACAGGTGAAAGGTCATGCTACATTTGTG
9VSP TGTTTTGGACAGATGGTGTGACAGTCTTTGGACAGGTGAAAGGTCATGCTACATTTGTG
TIGR4 TGTTTTGGACAGATGGTGTGACAGTCTTTGGACAGGTGAAAGGTCATGCTACATTTGTG
23FTW TGTTTTGGGCAGATGGTGTACAGTCTTTAGGACAAGTAAAAGGTCATGAGATATTTTCA
***** ***** ***** * ***** * ***** * ***** *

14CSR GAATCTGTGACGGCCGACAGTTACCAAGAGCAATTGCAACGGTTCGCTTGATTACAATCAA
670 GAATCTGTGACGGCCGACAGTTACCAAGAGCAATTGCAACGGTTCGCTTGATTACAATCAA
6BF GAATCTGTGACGGCCGACAGTTACCAAGAGCAATTGCAACGGTTCGCTTGATTACAATCAA
6BSP GAATCTGTGACGGCCGACAGTTACCAAGAGCAATTGCAACGGTTCGCTTGATTACAATCAA
19AH GAATCTGTGACGGCCGACAGTTACCAAGAGCAATTGCAACGGTTCGCTTGATTACAATCAA
23FPO AAATCCATGACAACACTGAAATGTACCAAGAACAACAGAACCATTCTCTCGCCTACAATCAA
19FTW AAATCCATGACAACACTGAAATGTACCAAGAACAACAGAACCATTCTCTCGCCTACAATCAA
9VSP AAATCCATGACAACACTGAAATGTACCAAGAACAACAGAACCATTCTCTCGCCTACAATCAA
TIGR4 AAATCCATGACAACACTGAAATGTACCAAGAACAACAGAACCATTCTCTCGCCTACAATCAA
23FTW GAATCTGTGACGGCCGACAGTTACCAAGAGCAATTGCAACGGTTCGCTTGATTACAATCAA
***** ***** * ** * ** * ** * ** * ** * ** * ** *

Figure 196AJ

14CSR CGCTTGGATTTCGAAAATCGTATTGTAGATCCTTTTTGGCGGAAGGGTATGAGGTAAT
670 CGCTTGGATTTCGAAAATCGTATTGTAGATCCTTTTTGGCGGAAGGGTATGAGGTAAT
6BF CGCTTGGATTTCGAAAATCGTATTGTAGATCCTTTTTGGCGGAAGGGTATGAGGTAAT
6BSP CGCTTGGATTTCGAAAATCGTATTGTAGATCCTTTTTGGCGGAAGGGTATGAGGTAAT
19AH CGCTTGGATTTCGAAAATCGTATTGTAGATCCTTTTTGGCGGAAGGGTATGAGGTAAT
23FPO CGCTTGGATTTCGAAAATCGTATTGTAGATCCTTTTTGGCGGAAGGGTATGAGGTAAT
19FTW CGCTTGGATTTCGAAAATCGTATTGTAGATCCTTTTTGGCGGAAGGGTATGAGGTAAT
9VSP CGCTTGGATTTCGAAAATCGTATTGTAGATCCTTTTTGGCGGAAGGGTATGAGGTAAT
TIGR4 CGCTTGGATTTCGAAAATCGTATTGTAGATCCTTTTTGGCGGAAGGGTATGAGGTAAT
23FTW CGCTTGGATTTCGAAAATCGTATTGTAGATCCTTTTTGGCGGAAGGGTATGAGGTAAT

14CSR TACCAAGTGTCTGACGATCCTGATGCAGTCTACGGCTATTTGTCGATTCCGAGTTTGGAA
670 TACCAAGTGTCTGACGATCCTGATGCAGTCTACGGCTATTTGTCGATTCCGAGTTTGGAA
6BF TACCAAGTGTCTGACGATCCTGATGCAGTCTACGGCTATTTGTCGATTCCGAGTTTGGAA
6BSP TACCAAGTGTCTGACGATCCTGATGCAGTCTACGGCTATTTGTCGATTCCGAGTTTGGAA
19AH TACCAAGTGTCTGACGATCCTGATGCAGTCTACGGCTATTTGTCGATTCCGAGTTTGGAA
23FPO TACCAAGTGTCTGACGATCCTGATGCAGTCTACGGCTATTTGTCGATTCCGAGTTTGGAA
19FTW TACCAAGTGTCTGACGATCCTGATGCAGTCTACGGCTATTTGTCGATTCCGAGTTTGGAA
9VSP TACCAAGTGTCTGACGATCCTGATGCAGTCTACGGCTATTTGTCGATTCCGAGTTTGGAA
TIGR4 TACCAAGTGTCTGACGATCCTGATGCAGTCTACGGCTATTTGTCGATTCCGAGTTTGGAA
23FTW TACCAAGTGTCTGACGATCCTGATGCAGTCTACGGCTATTTGTCGATTCCGAGTTTGGAA

14CSR ATCATGGAGCCAGTTTATCTAGGAGCGGATTACCATCATTTAGCAATGGGGTTGGCCCAT
670 ATCATGGAGCCAGTTTATCTAGGAGCGGATTACCATCATTTAGCAATGGGGTTGGCCCAT
6BF ATCATGGAGCCAGTTTATCTAGGAGCGGATTACCATCATTTAGCAATGGGGTTGGCCCAT
6BSP ATCATGGAGCCAGTTTATCTAGGAGCGGATTACCATCATTTAGCAATGGGGTTGGCCCAT
19AH ATCATGGAGCCAGTTTATCTAGGAGCGGATTACCATCATTTAGCAATGGGGTTGGCCCAT
23FPO ATCATGGAGCCAGTTTATCTAGGAGCGGATTACCATCATTTAGCAATGGGGTTGGCCCAT
19FTW ATCATGGAGCCAGTTTATCTAGGAGCGGATTACCATCATTTAGCAATGGGGTTGGCCCAT
9VSP ATCATGGAGCCAGTTTATCTAGGAGCGGATTACCATCATTTAGCAATGGGGTTGGCCCAT
TIGR4 ATCATGGAGCCAGTTTATCTAGGAGCGGATTACCATCATTTAGCAATGGGGTTGGCCCAT
23FTW ATCATGGAGCCAGTTTATCTAGGAGCGGATTACCATCATTTAGCAATGGGGTTGGCCCAT

14CSR GTGGATGGGACGCCTCTTCCCTGTTGAGGGAAAAGGGATTTCGTTTCAGTGATTGCTGGGCAC
670 GTGGATGGGACGCCTCTTCCCTGTTGAGGGAAAAGGGATTTCGTTTCAGTGATTGCTGGGCAC
6BF GTGGATGGGACGCCTCTTCCCTGTTGAGGGAAAAGGGATTTCGTTTCAGTGATTGCTGGGCAC
6BSP GTGGATGGGACGCCTCTTCCCTGTTGAGGGAAAAGGGATTTCGTTTCAGTGATTGCTGGGCAC
19AH GTGGATGGGACGCCTCTTCCCTGTTGAGGGAAAAGGGATTTCGTTTCAGTGATTGCTGGGCAC
23FPO GTGGATGGGACGCCTCTTCCCTGTTGAGGGAAAAGGGATTTCGTTTCAGTGATTGCTGGGCAC
19FTW GTGGATGGGACGCCTCTTCCCTGTTGAGGGAAAAGGGATTTCGTTTCAGTGATTGCTGGGCAC
9VSP GTGGATGGGACGCCTCTTCCCTGTTGAGGGAAAAGGGATTTCGTTTCAGTGATTGCTGGGCAC
TIGR4 GTGGATGGGACGCCTCTTCCCTGTTGAGGGAAAAGGGATTTCGTTTCAGTGATTGCTGGGCAC
23FTW GTGGATGGGACGCCTCTTCCCTGTTGAGGGAAAAGGGATTTCGTTTCAGTGATTGCTGGGCAC

14CSR CGTGCAGAACCAAGCCATGTCTTTTTCCGCCATTTGGATCAGCTAAAAGTTGGAGATGCT
670 CGTGCAGAACCAAGCCATGTCTTTTTCCGCCATTTGGATCAGCTAAAAGTTGGAGATGCT
6BF CGTGCAGAACCAAGCCATGTCTTTTTCCGCCATTTGGATCAGCTAAAAGTTGGAGATGCT
6BSP CGTGCAGAACCAAGCCATGTCTTTTTCCGCCATTTGGATCAGCTAAAAGTTGGAGATGCT
19AH CGTGCAGAACCAAGCCATGTCTTTTTCCGCCATTTGGATCAGCTAAAAGTTGGAGATGCT
23FPO CGTGCAGAACCAAGCCATGTCTTTTTCCGCCATTTGGATCAGCTAAAAGTTGGAGATGCT
19FTW CGTGCAGAACCAAGCCATGTCTTTTTCCGCCATTTGGATCAGCTAAAAGTTGGAGATGCT
9VSP CGTGCAGAACCAAGCCATGTCTTTTTCCGCCATTTGGATCAGCTAAAAGTTGGAGATGCT
TIGR4 CGTGCAGAACCAAGCCATGTCTTTTTCCGCCATTTGGATCAGCTAAAAGTTGGAGATGCT
23FTW CGTGCAGAACCAAGCCATGTCTTTTTCCGCCATTTGGATCAGCTAAAAGTTGGAGATGCT

Figure 196AK

PCT/US05/27239

430/487

14CSR CTTTATTATGATAATGGCCAGGAAATTGTAGAATATCAGATGATGGACACAGAGATTATT
670 CTTTATTATGATAATGGCCAGGAAATTGTAGAATATCAGATGATGGACACAGAGATTATT
6BF CTTTATTATGATAATGGCCAGGAAATTGTAGAATATCAGATGATGGACACAGAGATTATT
6BSP CTTTATTATGATAATGGCCAGGAAATTGTAGAATATCAGATGATGGACACAGAGATTATT
19AH CTTTATTATGATAATGGCCAGGAAATTGTAGAATATCAGATGATGGACACAGAGATTATT
23FPO CTTTATTATGATAATGGCCAGGAAATTGTAGAATATCAGATGATGGACACAGAGATTATT
19FTW CTTTATTATGATAATGGCCAGGAAATTGTAGAATATCAGATGATGGACACAGAGATTATT
9VSP CTTTATTATGATAATGGCCAGGAAATTGTAGAATATCAGATGATGGACACAGAGATTATT
TIGR4 CTTTATTATGATAATGGCCAGGAAATTGTAGAATATCAGATGATGGACACAGAGATTATT
23FTW CTTTATTATGATAATGGCCAGGAAATTGTAGAATATCAGATGATGGACACAGAGATTATT

14CSR TTACCGTCGGAATGGGAAAAATTAGAATCGGTTAGCTCTAAAAATATCATGACCTTGATA
670 TTACCGTCGGAATGGGAAAAATTAGAATCGGTTAGCTCTAAAAATATCATGACCTTGATA
6BF TTACCGTCGGAATGGGAAAAATTAGAATCGGTTAGCTCTAAAAATATCATGACCTTGATA
6BSP TTACCGTCGGAATGGGAAAAATTAGAATCGGTTAGCTCTAAAAATATCATGACCTTGATA
19AH TTACCGTCGGAATGGGAAAAATTAGAATCGGTTAGCTCTAAAAATATCATGACCTTGATA
23FPO TTACCGTCGGAATGGGAAAAATTAGAATCGGTTAGCTCTAAAAATATCATGACCTTGATA
19FTW TTACCGTCGGAATGGGAAAAATTAGAATCGGTTAGCTCTAAAAATATCATGACCTTGATA
9VSP TTACCGTCGGAATGGGAAAAATTAGAATCGGTTAGCTCTAAAAATATCATGACCTTGATA
TIGR4 TTACCGTCGGAATGGGAAAAATTAGAATCGGTTAGCTCTAAAAATATCATGACCTTGATA
23FTW TTACCGTCGGAATGGGAAAAATTAGAATCGGTTAGCTCTAAAAATATCATGACCTTGATA

14CSR ACCTGCGATCCGATTCCCTACCTTTAATAAACGCTTATTAGTGAATTTTGAACGAGTCGCT
670 ACCTGCGATCCGATTCCCTACCTTTAATAAACGCTTATTAGTGAATTTTGAACGAGTCGCT
6BF ACCTGCGATCCGATTCCCTACCTTTAATAAACGCTTATTAGTGAATTTTGAACGAGTCGCT
6BSP ACCTGCGATCCGATTCCCTACCTTTAATAAACGCTTATTAGTGAATTTTGAACGAGTCGCT
19AH ACCTGCGATCCGATTCCCTACCTTTAATAAACGCTTATTAGTGAATTTTGAACGAGTCGCT
23FPO ACCTGCGATCCGATTCCCTACCTTTAATAAACGCTTATTAGTGAATTTTGAACGAGTCGCT
19FTW ACCTGCGATCCGATTCCCTACCTTTAATAAACGCTTATTAGTGAATTTTGAACGAGTCGCT
9VSP ACCTGCGATCCGATTCCCTACCTTTAATAAACGCTTATTAGTGAATTTTGAACGAGTCGCT
TIGR4 ACCTGCGATCCGATTCCCTACCTTTAATAAACGCTTATTAGTGAATTTTGAACGAGTCGCT
23FTW ACCTGCGATCCGATTCCCTACCTTTAATAAACGCTTATTAGTGAATTTTGAACGAGTCGCT

14CSR GTTTATCAAAAAATCAGATCCACAAACAGCTGCAGTTGCGAGGGTTGCTTTTACGAAAGAA
670 GTTTATCAAAAAATCAGATCCACAAACAGCTGCAGTTGCGAGGGTTGCTTTTACGAAAGAA
6BF GTTTATCAAAAAATCAGATCCACAAACAGCTGCAGTTGCGAGGGTTGCTTTTACGAAAGAA
6BSP GTTTATCAAAAAATCAGATCCACAAACAGCTGCAGTTGCGAGGGTTGCTTTTACGAAAGAA
19AH GTTTATCAAAAAATCAGATCCACAAACAGCTGCAGTTGCGAGGGTTGCTTTTACGAAAGAA
23FPO GTTTATCAAAAAATCAGATCCACAAACAGCTGCAGTTGCGAGGGTTGCTTTTACGAAAGAA
19FTW GTTTATCAAAAAATCAGATCCACAAACAGCTGCAGTTGCGAGGGTTGCTTTTACGAAAGAA
9VSP GTTTATCAAAAAATCAGATCCACAAACAGCTGCAGTTGCGAGGGTTGCTTTTACGAAAGAA
TIGR4 GTTTATCAAAAAATCAGATCCACAAACAGCTGCAGTTGCGAGGGTTGCTTTTACGAAAGAA
23FTW GTTTATCAAAAAATCAGATCCACAAACAGCTGCAGTTGCGAGGGTTGCTTTTACGAAAGAA

14CSR GGACAATCTGTATCGCGTGTGCAACCTCTCAATGGTTGTACCGTGGGCTAGTGGTACTG
670 GGACAATCTGTATCGCGTGTGCAACCTCTCAATGGTTGTACCGTGGGCTAGTGGTACTG
6BF GGACAATCTGTATCGCGTGTGCAACCTCTCAATGGTTGTACCGTGGGCTAGTGGTACTG
6BSP GGACAATCTGTATCGCGTGTGCAACCTCTCAATGGTTGTACCGTGGGCTAGTGGTACTG
19AH GGACAATCTGTATCGCGTGTGCAACCTCTCAATGGTTGTACCGTGGGCTAGTGGTACTG
23FPO GGACAATCTGTATCGCGTGTGCAACCTCTCAATGGTTGTACCGTGGGCTAGTGGTACTG
19FTW GGACAATCTGTATCGCGTGTGCAACCTCTCAATGGTTGTACCGTGGGCTAGTGGTACTG
9VSP GGACAATCTGTATCGCGTGTGCAACCTCTCAATGGTTGTACCGTGGGCTAGTGGTACTG
TIGR4 GGACAATCTGTATCGCGTGTGCAACCTCTCAATGGTTGTACCGTGGGCTAGTGGTACTG
23FTW GGACAATCTGTATCGCGTGTGCAACCTCTCAATGGTTGTACCGTGGGCTAGTGGTACTG

Figure 196AL

PCT/US05/27239 431/487

14CSR	GCATTTCTGGGAATCCTGTTTGTGTTTGTGGAAGCTAGCACGTTTACTACGAGGGAAATAA
670	GCATTTCTGGGAATCCTGTTTGTGTTTGTGGAAGCTAGCACGTTTACTACGAGGGAAATAA
6BF	GCATTTCTGGGAATCCTGTTTGTGTTTGTGGAAGCTAGCACGTTTACTACGAGGGAAATAA
6BSP	GCATTTCTGGGAATCCTGTTTGTGTTTGTGGAAGCTAGCACGTTTACTACGAGGGAAATAA
19AH	GCATTTATGGGAATCCTGTTTGTGTTTGTGGAAGCTAGCACGTTTACTACGAGGGAAATAA
23FPO	GCATTTCTGGGAATCCTGTTTGTGTTTGTGGAAGCTAGCACGTTTACTACGAGGGAAATAA
19FTW	GCATTTCTGGGAATCCTGTTTGTGTTTGTGGAAGCTAGCACGTTTACTACGAGGGAAATAA
9VSP	GCATTTCTGGGAATCCTGTTTGTGTTTGTGGAAGCTAGCACGTTTACTACGAGGGAAATAA
TIGR4	GCATTTCTGGGAATCCTGTTTGTGTTTGTGGAAGCTAGCACGTTTACTACGAGGGAAATAA
23FTW	GCATTTCTGGGAATCCTGTTTGTGTTTGTGGAAGCTAGCACGTTTACTACGAGGGAAATAA

14CSR	AAAGAAATGAAAGGAAAGCTAAGGCTGTTCCCTTTTTCCGGCTCTTTGTCAACTGTAGGGG
670	AAAGAAATGAAAGGAAAGCTAAGGCTGTTCCCTTTTTCCGGCTCTTTGTCAACTGTAGTGG
6BF	AAAGAAATGAAAGGAAAGCTAAGGCTGTTCCCTTTTTCCGGCTCTTTGTCAACTGTAG---
6BSP	AAAGAAATGAAAGGAAAGCTAAGGCTGTTCCCTTTTTCCGGCTCTTTGTCAACTGTAG---
19AH	AAAGAAATGAAAGGAAAGCTAAGGCTGTTCCCTTTTTCCGGCTCTTTGTCAACTGTAG---
23FPO	AAAGAAATGAAAGGAAAGCTAAGGCTGTTCCCTTTTTCCGGCTCTTTGTCAACTGT-----
19FTW	AAAGAAATGAAAGGAAAGCTAAGGCTGTTCCCTTTTTCCGGCTCTTTGTCAACTGTAGT--
9VSP	AAAGAAATGAAAGGAAAGCTAAGGCTGTTCCCTTTTTCCGGCTCTTTGTCAACTGTAG---
TIGR4	AAAGAAATGAAAGGAAAGCTAAGGCTGTTCCCTTTTTCCGGCTCTTTGTCAACTGTAGTGG
23FTW	AAAGAAATGAAAGGAAAGCTAAGGCTGTTCCCTTTTTCCGGCTCTTTGTCAACTGT-----

Figure 196AM

Figure 197

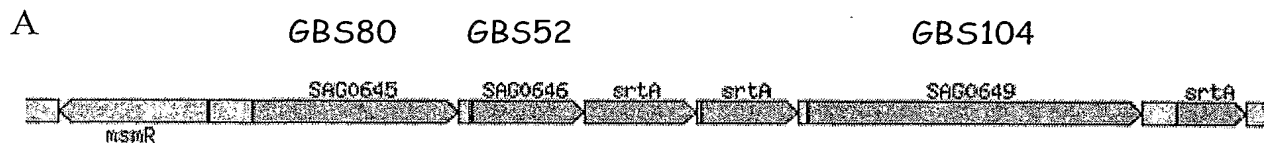

B

Intergenic region between AraC R and GBS 80

AraC . . CAT

TTGATAGAC**CCGCCTTC**ATTATCATTCTAGAAATTTTCTTTAGGTTTGTA
 AAGACTACAAAATAAAATGATGAAAACAACATCTTGTGGATACACTAAA
 AAGACACGCTAATTAGCAAACCTCTCTTCATCATCTCTCACCATTATTA
 TACTAC **TATTTATAT**GACAAATAAAGGT**G**ATTT **TGTTAA**AATATAACTTT
 GAAAATCCACATATATTTTAAATCTTCCGTCT**GAAAAA**AATAAAAAT
 AGTAAAAATAAACACGAATTTAAAATAAGCAAATTTTAAAGAAAATCTG
 TGCTAAACTTTAATAGTTTTGTGCTTAATAATAATCAGCACTTACAAAGA
 ACAAAGGGAAAAGCGAG**GAGAG**AACTTTTA **ATG . . GBS80**

C

187	4A		5A		5A
233	6A		6A		7A
Strain	FACS α -80	Strain	FACS α -80	Strain	FACS α -80
1998	95	5364	454	2129	57
2110	0	JMV071	556	2274	113
2603	62	JM91003	587	5401	170
3050	43	CJB111	365	5408	0
5376	165			5518	31
M781	65			CJB110	71
COH1	305 (G->T 179)			J7357B	91
18rs 21	0 (STOP, no LPXTG)			COH31	0

PCT/US05/2723433/487

AI-1											
			aa	M1	M3	M5	M18	M49	M6	M12	
M6											
50913503	M6_Spy0157	LPXTG	628	gas15 30%in593aa	M3-0098 46%in256aa M3-0104 28%in563aa		M18-0132 24%in701aa			M12-4134 74%in703aa	Fibronectin-binding protein (protein F)
50913505	M6_Spy0159	LPXSG	1037		M3-0104 25%in339aa					M12-4141 37%in98aa	Collagen adhesion protein
50913506	M6_Spy0160	LPXTG	557								Fimbrial structural subunit

Figure 198

AI-2									
	aa	M1	M3	M5	M18	M49	M6	M12	
M1									
gas15	VXGTG		M3-0098 50%in738aa	M5-orf78 60%in462aa	M18-0126 54%in469aa			M12-4135 54%in747aa	Cpa
13621428 SPy0128 gas16	EVXGTG		M3-0100 40%in354aa	M5-orf80 41%in358aa	M18-0128 38%in357aa			M12-4137 40%in354aa	hypothetical protein (fimbrial)
13621430 SPy0130 gas18	LPXGTG		M3-0102 32%200aa	M5-orf82 31%in213aa	M18-0130 32%in213aa			M12-4139 31%in206aa	hypothetical protein

Figure 199

AI-3										
		aa	M1	M3	M5	M18	M49	M6	M12	
M3										
21909634	SpyM3_0098	744	gas15 51%in739aa		M5-orf78 58%in484aa	M18-0126 74%in482aa			M12-4135 55%in751aa	putative collagen binding protein (Cpb)
21909636	SpyM3_0100	344	gas16 40%in354aa		M5-orf80 64%in349aa	M18-0128 67%in345aa			M12-4137 61%in344aa	conserved hypothetical al protein (fimbrial)
21909638	SpyM3_0102	195	gas18 32%in200aa		M5-orf82 98%in183aa	M18-0130 97%in183aa			M12-4139 99%in183aa	hypothetical al protein
21909640	SpyM3_0104	696			M5-orf84 88%in656aa	M18-0132 88%in656aa			M12-4141 59%in612aa	protein F2 like fibronectin -binding

Figure 200A

M18	19745301	spyM18_0126	VPXTG	524	gas15 54%in469aa	M3-0098 74%in482	M5-orf78 61%in528aa	M12-4135 59%in489aa	putative collagen binding protein (Cpb)
	19745303	spyM18_0128	QVXTG	344	gas16 38%in357aa	M3-0100 67%in345aa	M5-orf80 60%in349aa	M12-4137 62%in344aa	conserved hypothetical al-protein (fimbrial)
	19745305	spyM18_0130	LPXAG	195	gas18 32%in213aa	M3-0102 97%in189aa	M5-orf82 99%in195aa	M12-4139 97%in189aa	hypothetical al-protein
	19745307	spyM18_0132	LPXTG	696		M3-0104 88%in656aa	M5-orf84 100%in696aa	M12-4141 50%in701aa	protein F2 like fibronectin-binding

Figure 200B

M49																						
56808848	VPXTG	744	gas15 55%in738aa	M3-0098 72%in743aa	M5-orf78 78%in483	M18-0126 61% in484	M12-4135 73%in752aa															putative collagen binding protein (Cpb)
56808846	QVXTG	344	gas16 36%in356aa	M3-0100 66%in345aa	M5-orf80 61%in349aa	M18-0128 90%in344aa	M12-4137 62%in344aa															conserved hypothetical al protein (fimbrial)
56808844	LPXAG	189	gas18 31%in206aa	M3-102 98%in189aa	M5-orf82 98%in189aa	M18-0130 98%in189aa	M12-4139 98%in189aa															hypothetical al protein
56808842	LPXTG	1160		M3-104 59%in612aa	M5-orf84 50%in701aa	M18-0132 50%in701aa	M12-4141 91%in1164aa	M6-0157 32%in296aa														protein F2 like fibronectin -binding

Figure 200D

AI-4										
		aa	M1	M3	M5	M18	M49	M6	M12	
M12										
19224134	LPXTG	698	gas15 44%in297aa	M3-0098 49%in254aa				M6-0157 74%in703aa		protein F
19224135	VPXTG	756	gas15 54%in747aa	M3-0098 55%in751aa	orf78 80%in484aa	M18-0126 59%in483aa		M6-0157 51%in275aa		Cpa
19224137	QVXTG	342	gas16 40%in354aa	M3-0100 61%in344aa	orf80 65%in384aa	M18-0128 62%in344aa				EfLSLA (fimbrial)
19224139	LPXAG	189	gas18 31%in206aa	M3-0102 99%in183aa	orf82 98%in189aa	M18-130 97%in189aa				Orf2
19224141	LPXTG	1161		M3-0104 59%in612aa	orf84 50%in701aa	M18-0132 50%in701aa				protein F2

Figure 201

Figure 202

GBS80 recombinant protein does not bind to epithelial cells

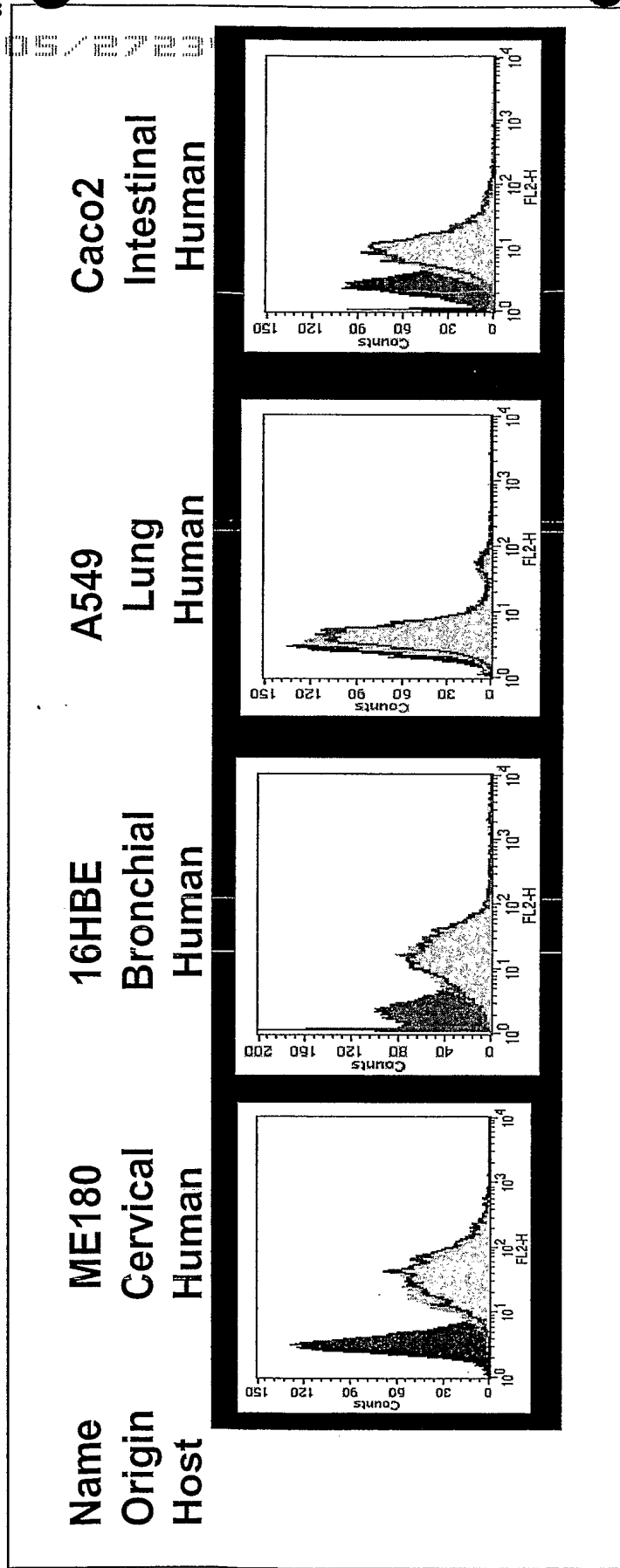

Epithelial cells were incubated in the presence or absence of GBS80 protein and then a mouse a-GBS80 polyclonal antibody added. The cell were then stained with FITC-conjugated a-mouse IgG antibody. The violet area indicates cells treated with FITC-conjugated antibody alone. GBS80 binding, expressed as Dmean channel values, was measured by FACScan cytometer as difference in fluorescence intensity between cell incubated with or without GBS80. The same protocol was used for GBS101 protein binding to epithelial cells

Figure 203

Deletion of GBS80 protein does not affect the ability of GBS to adhere and invade ME180

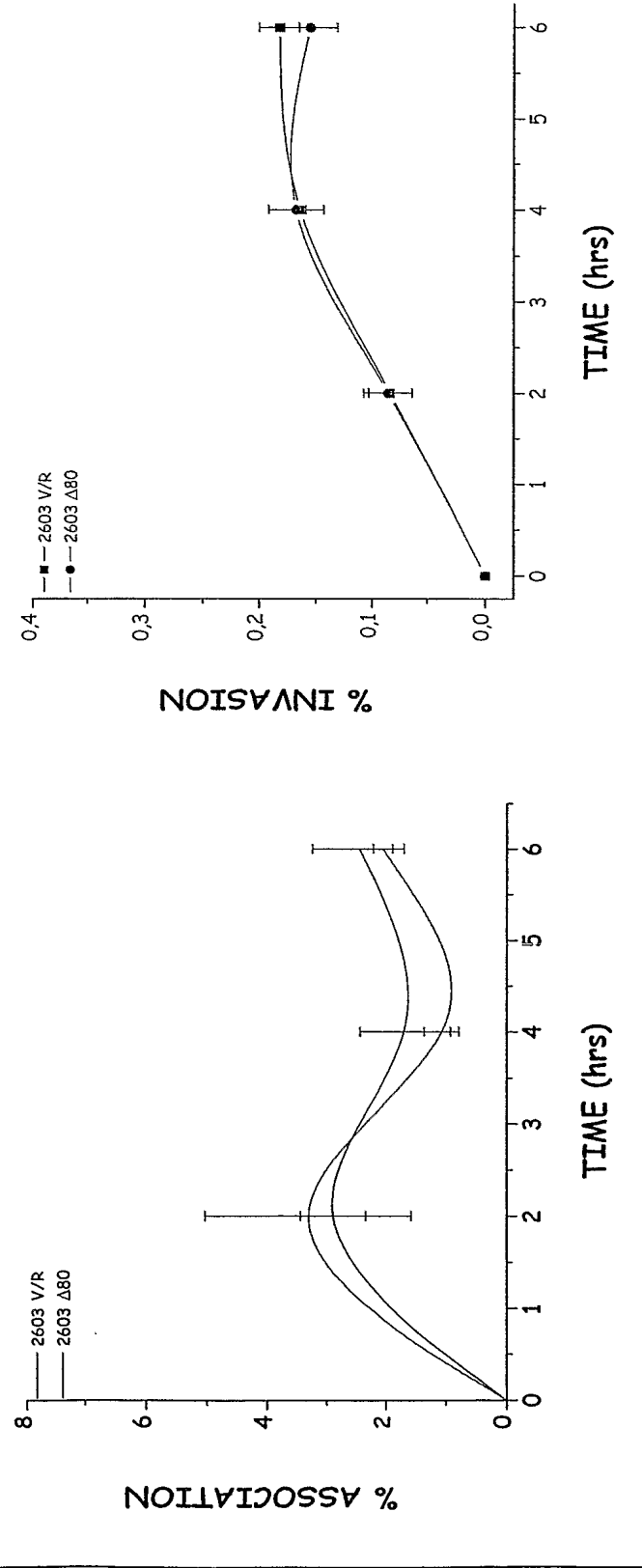

ME180 cervical carcinoma epithelial cells were infected with GBS 2603 wild type or 2603 D80 isogenic mutant. After 2h infection, non-adherent bacteria were washed off and infection prolonged for further 2h and 4h. In invasion experiments, after each time point followed a 2h antibiotic treatment. Cells were then lysed with 1% saponin and lysates plated on TSA plates.

Figure 204

GBS80 binds to ECM proteins

ELISA with purified ECM components and native GBS80 protein

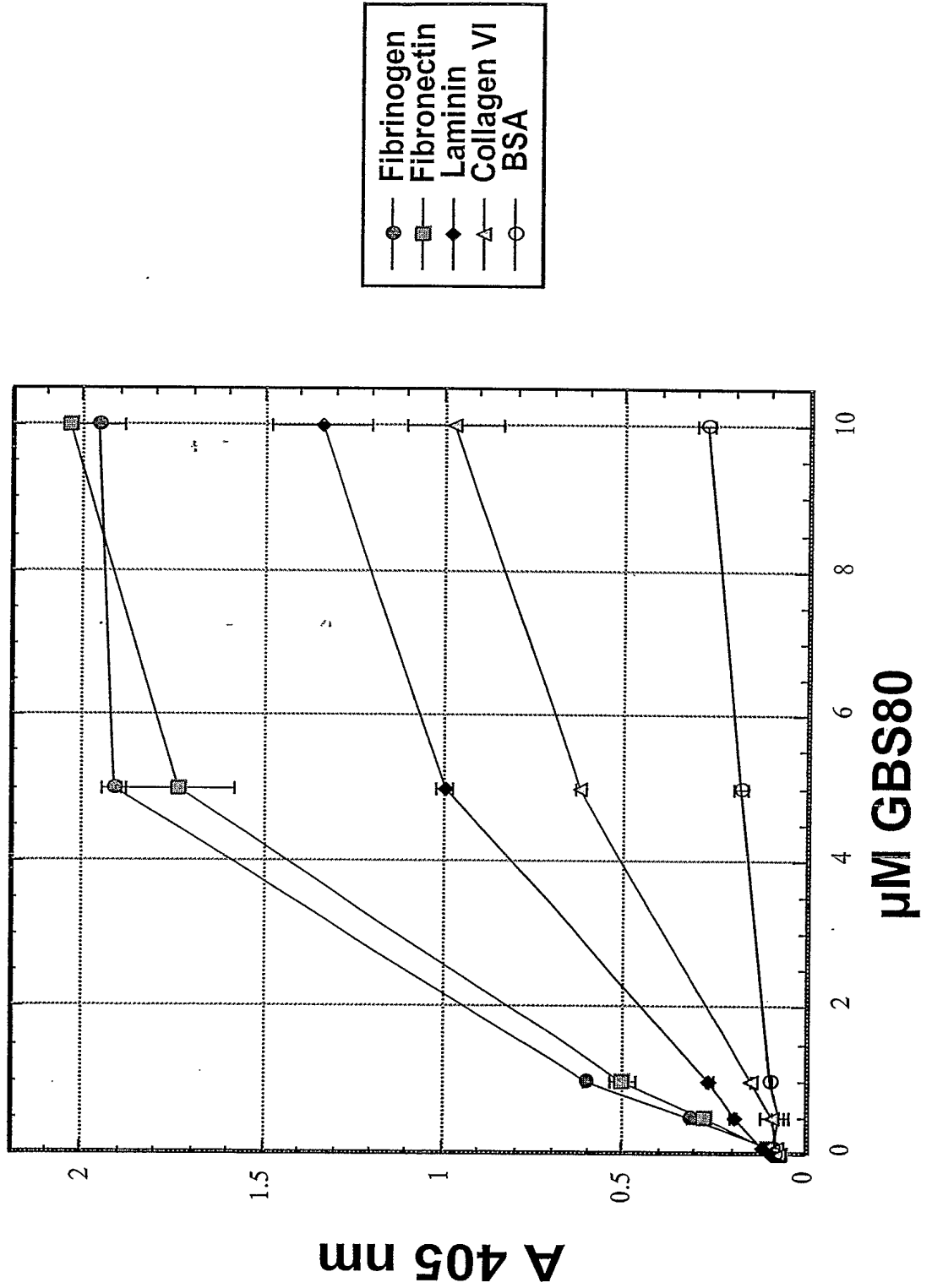
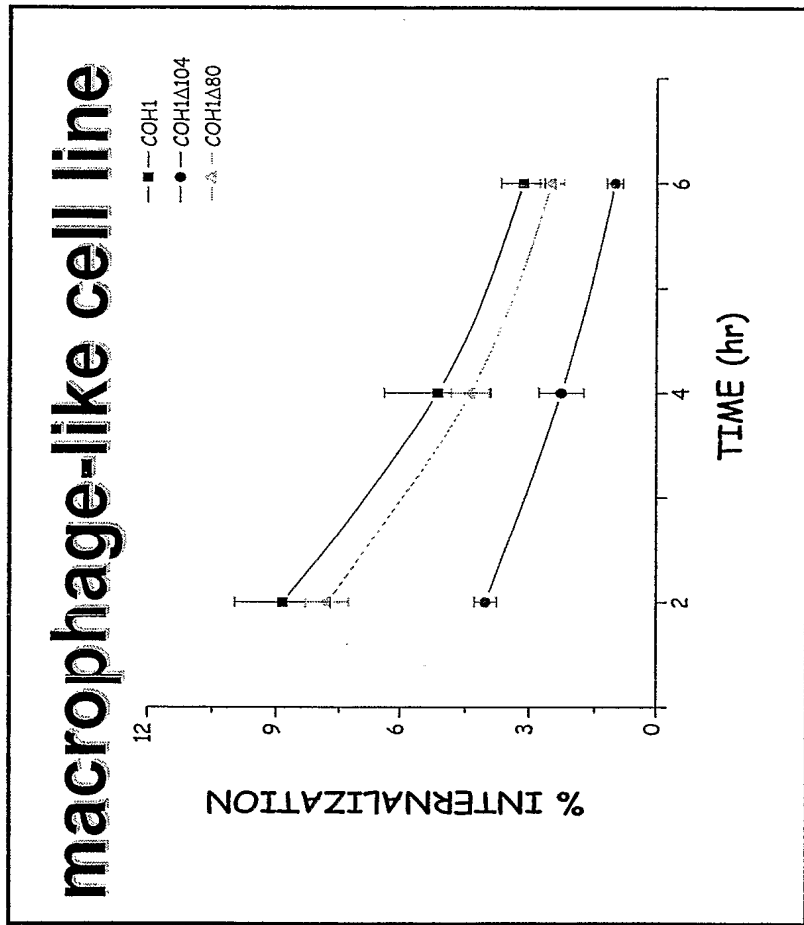

Figure 205

Deletion of GBS104 protein, but not GBS80, reduces the capacity of GBS to invade J774 macrophage-like cell line



J774 cells were infected with GBS COH1 wild type or COH1ΔGBS104/COH1ΔGBS80 isogenic mutants. After 1h infection, non-adherent bacteria were washed off and intracellular bacteria recovered at 2h, 4h and 6h post-antibiotic treatment. At each time point cells were lysed with 0.25% Triton X-100 and

Figure 206

**GBS104 knockout mutant strain translocates
 through an epithelial monolayer less efficiently than
 the isogenic wild type**

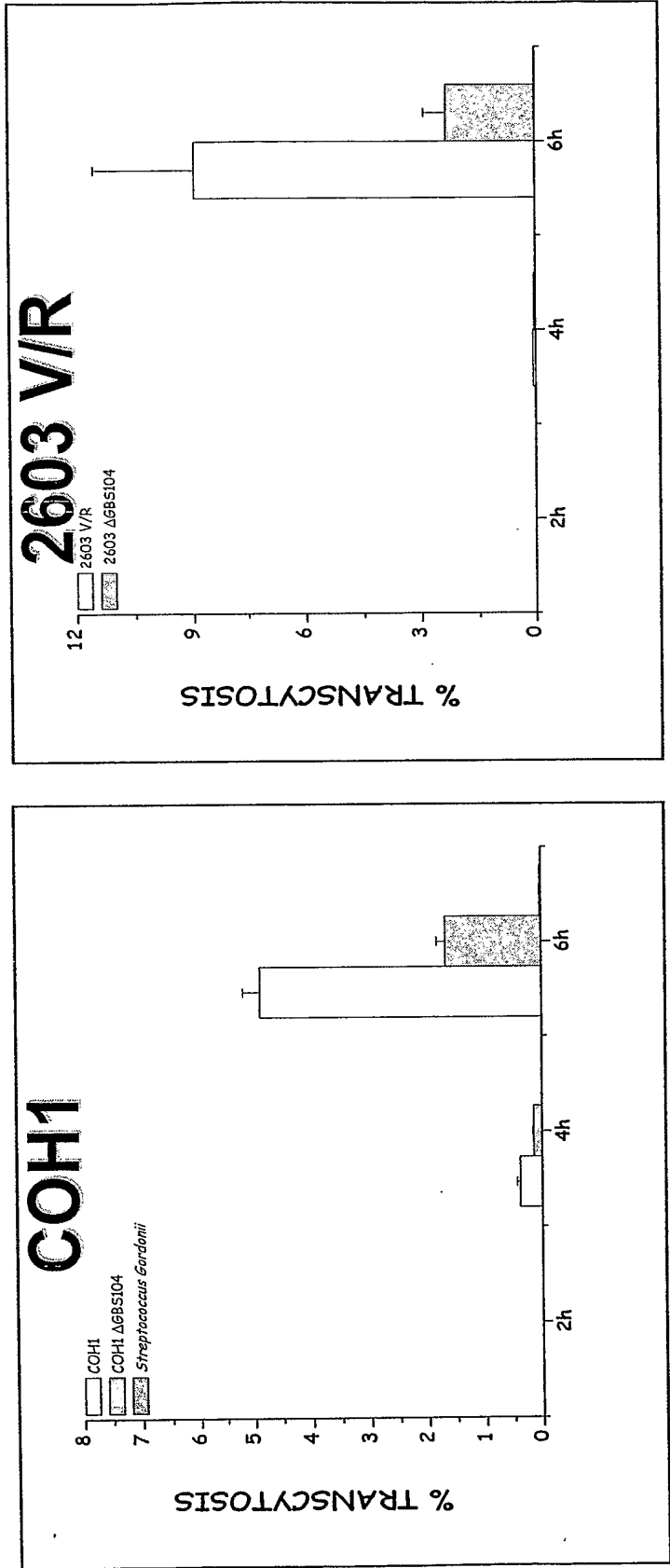
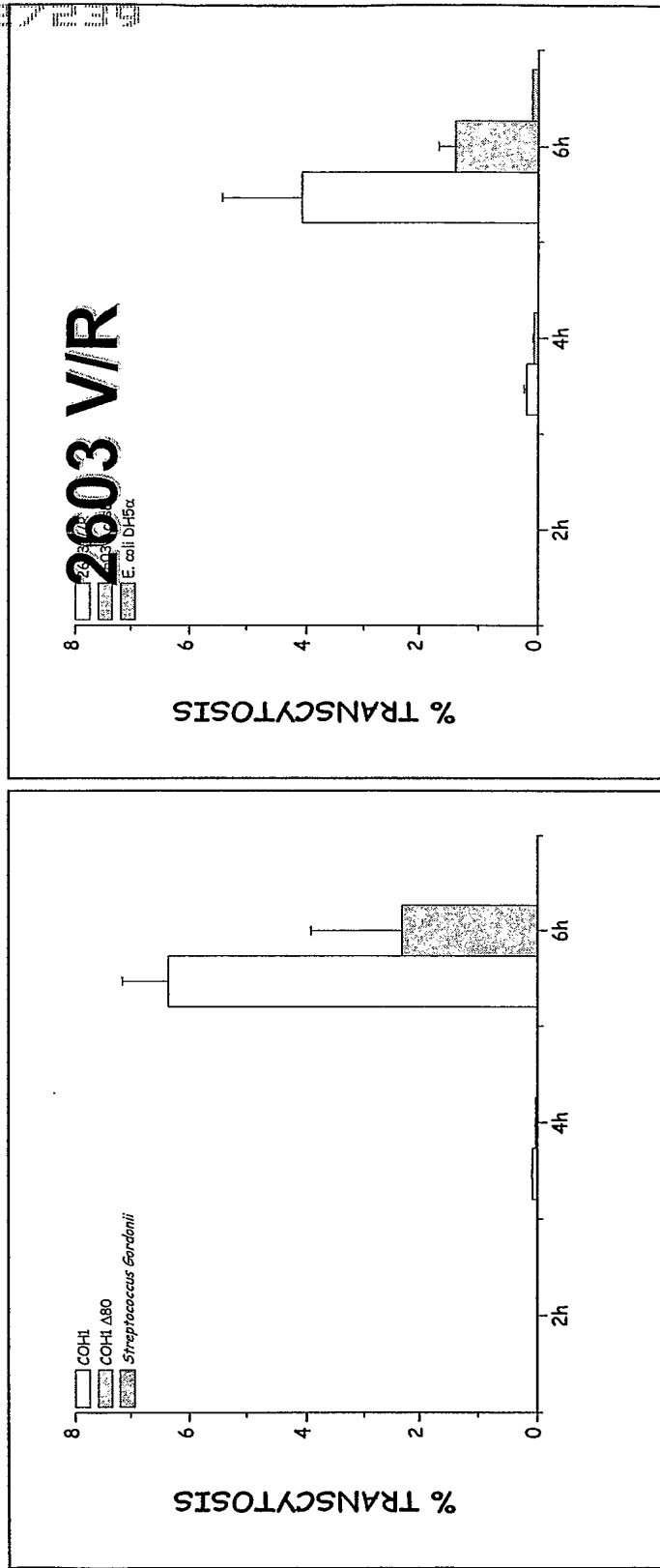

Figure 207

GBS80 knockout mutant strain partially loses the ability to translocate through an epithelial monolayer



Epithelial cells monolayers were inoculated with each bacterium in the apical chamber of a transwell system for 2h and then non-adherent bacteria washed off. Infection was prolonged for further 2h and 4h. Samples were taken from the media of the basolateral side and the number of colony forming units measured. Transepithelial electrical resistance measured prior and after infection gave comparable values, indicating the maintenance of the integrity of the monolayer.

Figure 208

GBS adherence to HUVEC endothelial cells

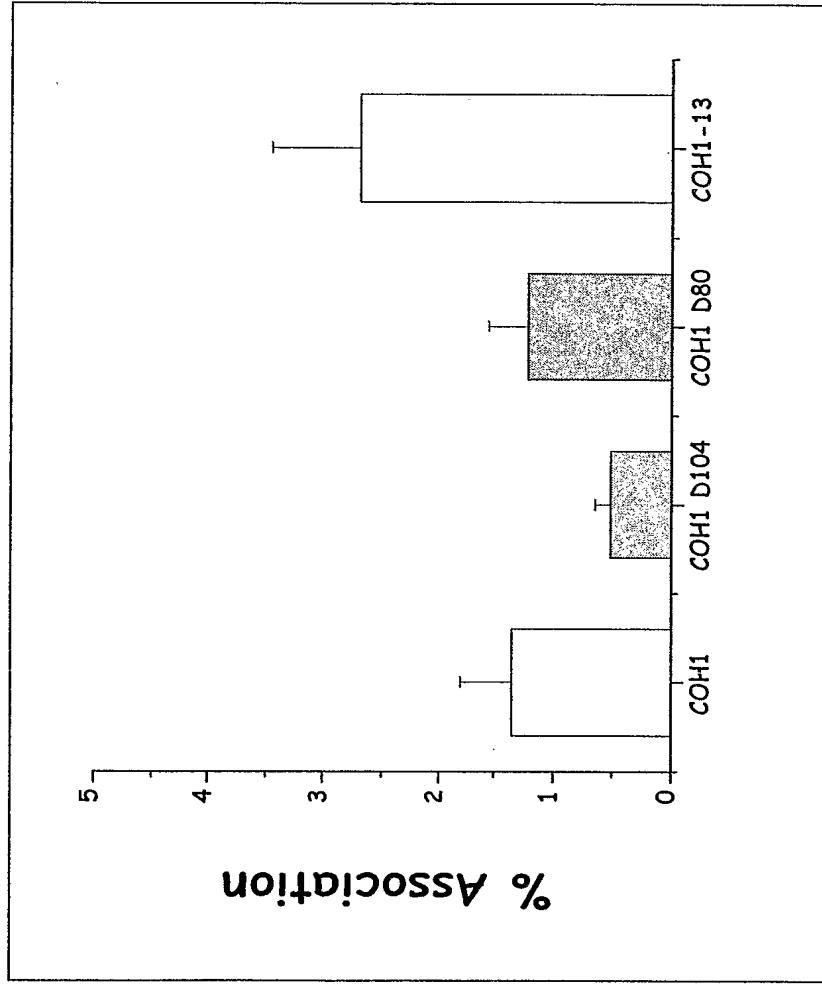

HUVEC cells were infected with GBS COH1 wild type or COH1DGBS104/COH1DGBS80 isogenic mutants. After 1h infection, non-adherent bacteria were washed off and cells lysed with 1% saponin and lysates plated on TSA plates.

PCT/US2005/027239

Figure 210

Binding of recombinant GBS104 protein to epithelial cells

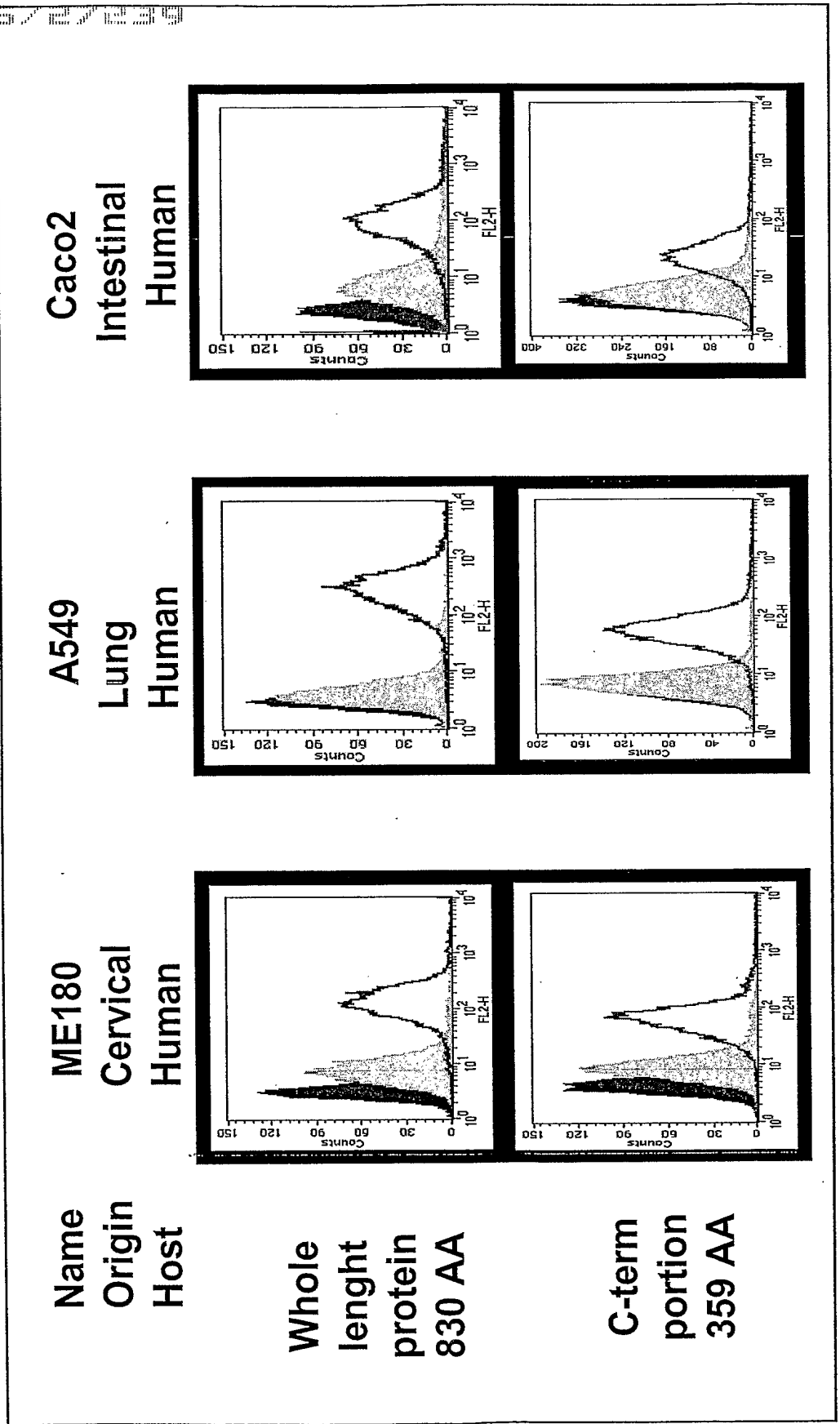
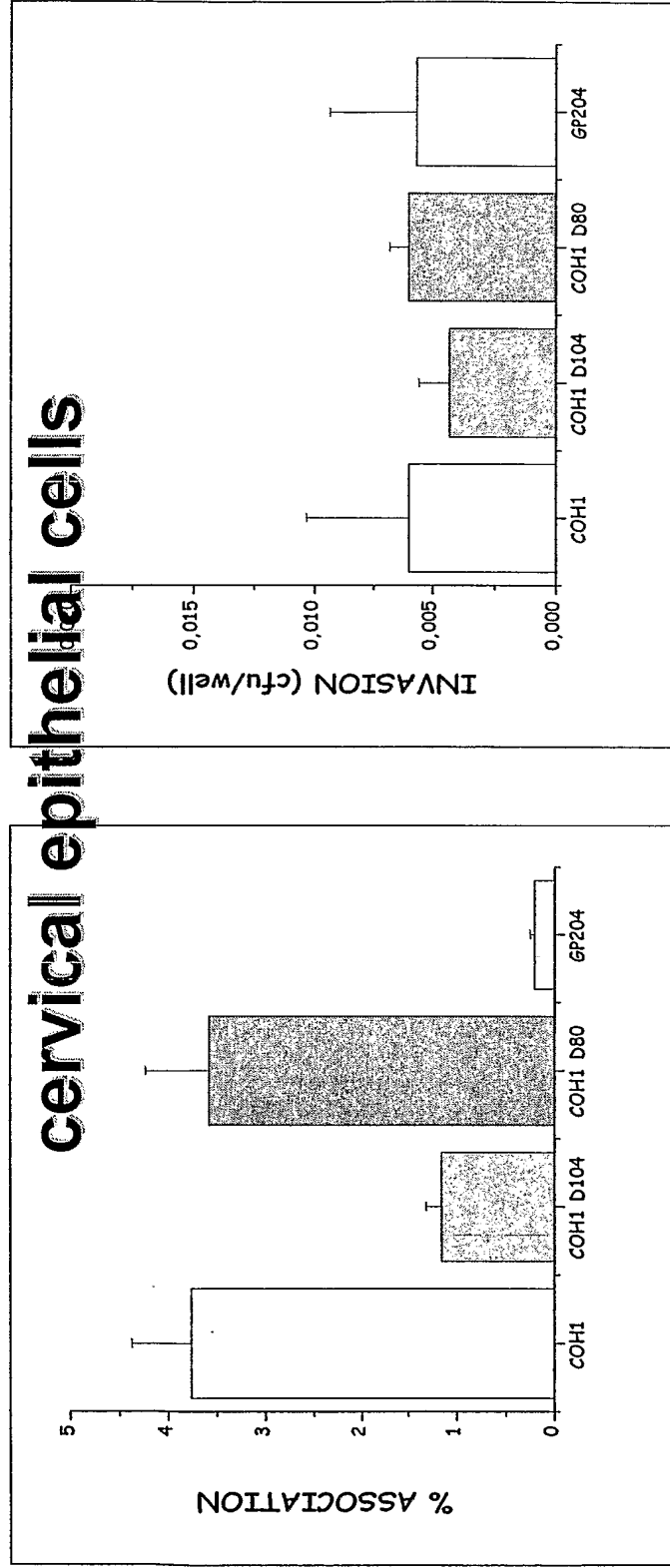

Figure 211

Deletion of GBS104 protein in the GBS strain COH1 reduces the ability of GBS to adhere to ME180



ME180 cervical carcinoma epithelial cells were infected with GBS COH1 wild type or COH1DGBS104/ COH1DGBS80 isogenic mutants. After 1h infection, non-adherent bacteria were washed off and cells lysed with 1% saponin and lvsates plated on TSA plates

Figure 212

COH1 overexpressing GBS80 protein has an impaired capacity to translocate through an epithelial monolayer

ME180 cells

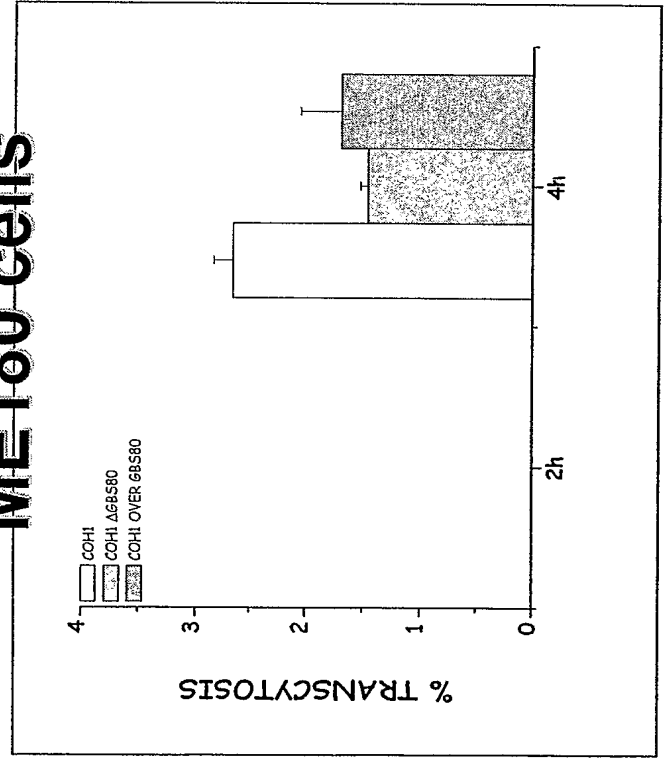

Caco2 cells

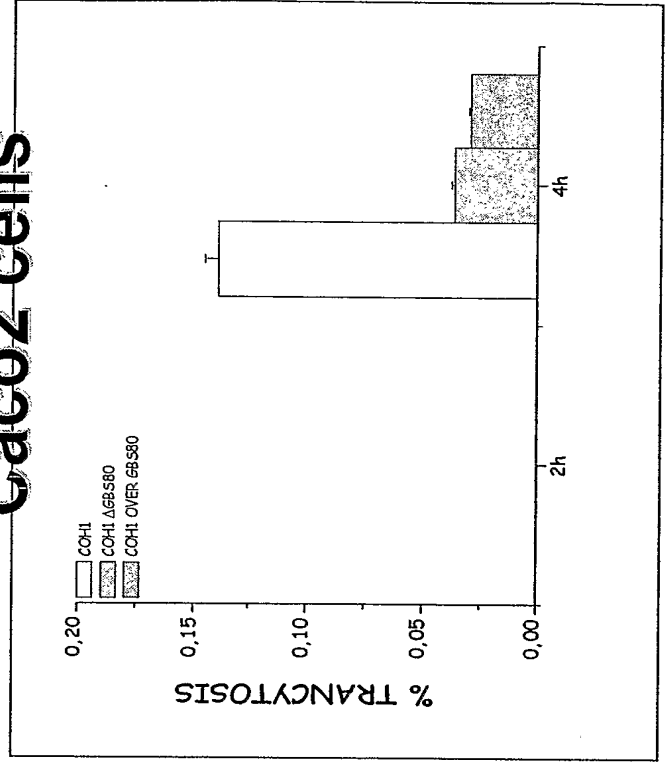

Figure 213

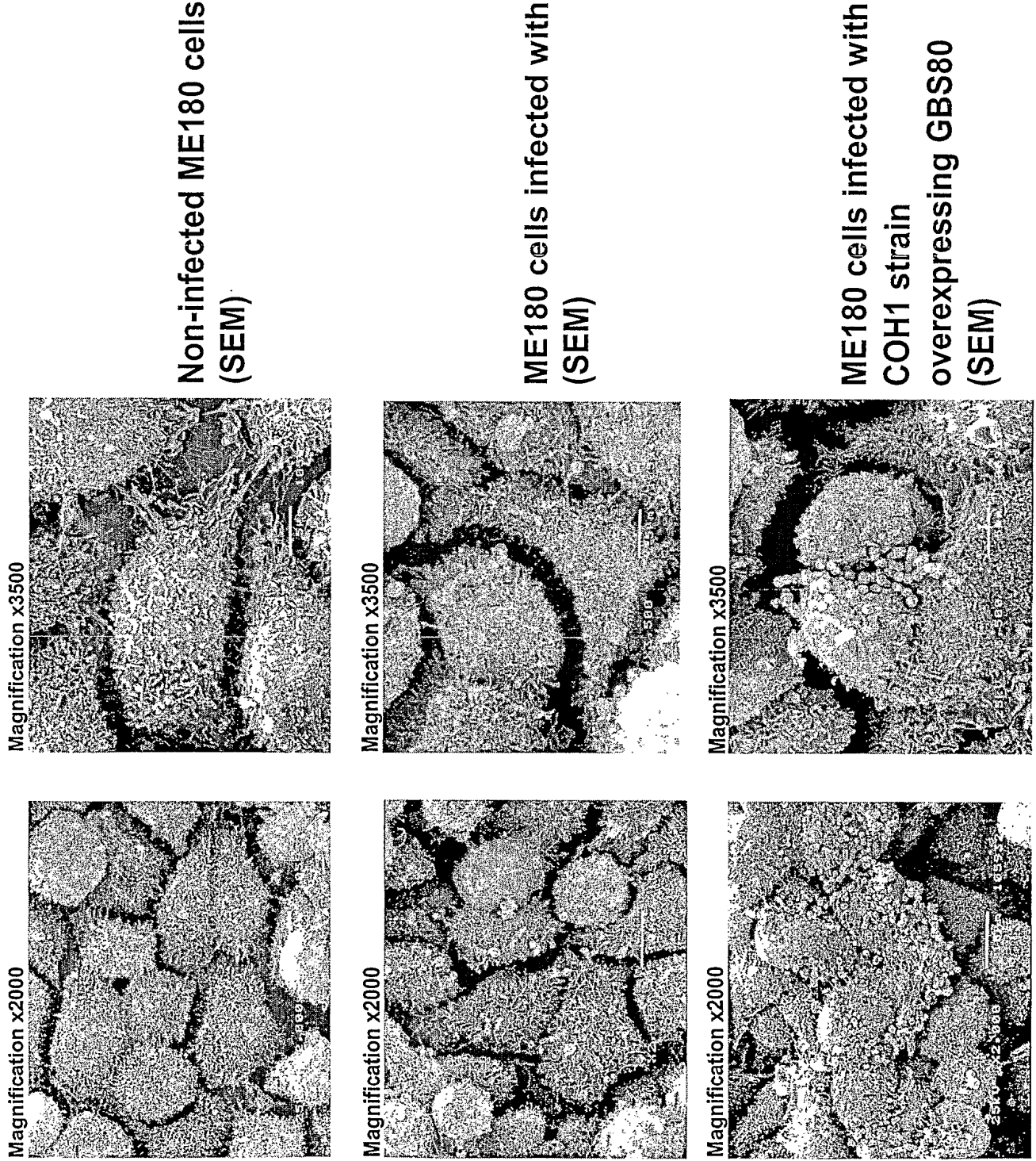

Figure 214

OH1 infection of ME180 cells

F-actin Blue

α -serotype III capsule Red

α -GBS80 Green

OH1 overexpressing GBS80

infection of ME180 cells

F-actin Blue

α -serotype III capsule Red

α -GBS80 Green

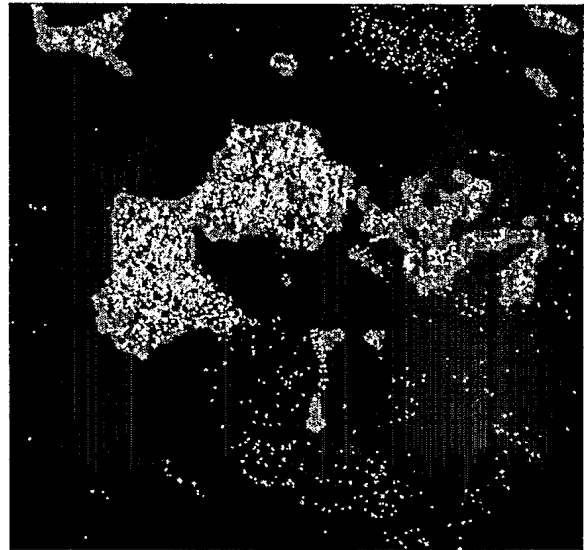
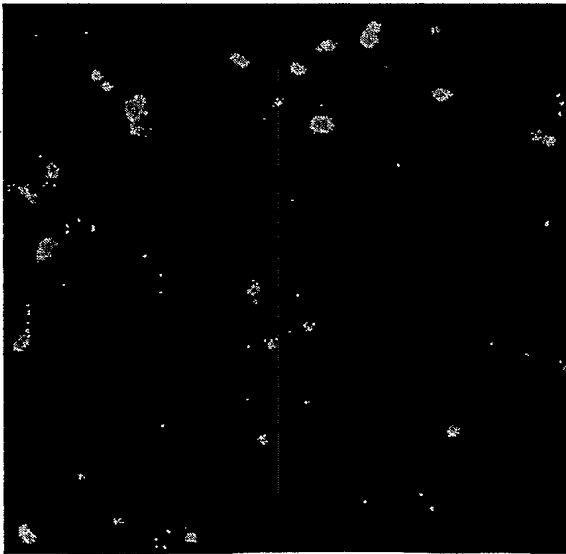
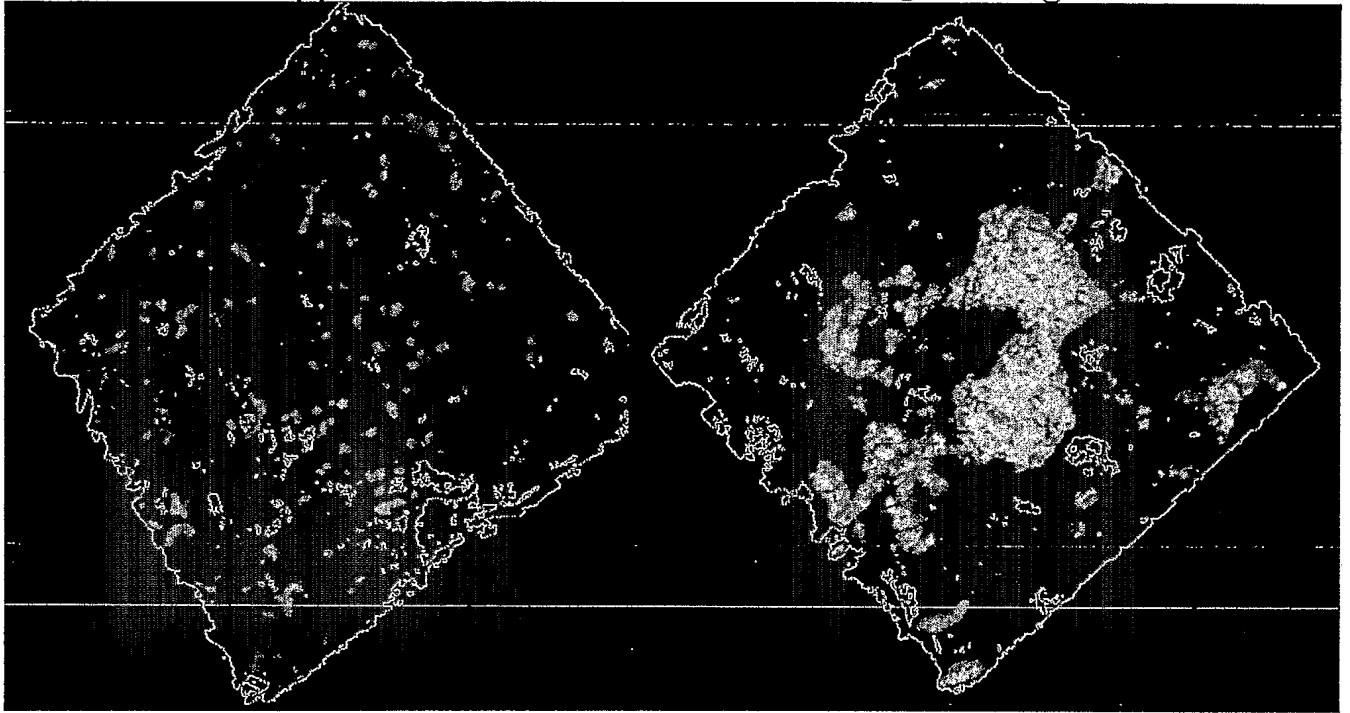

453/487

515 Δ 59p59

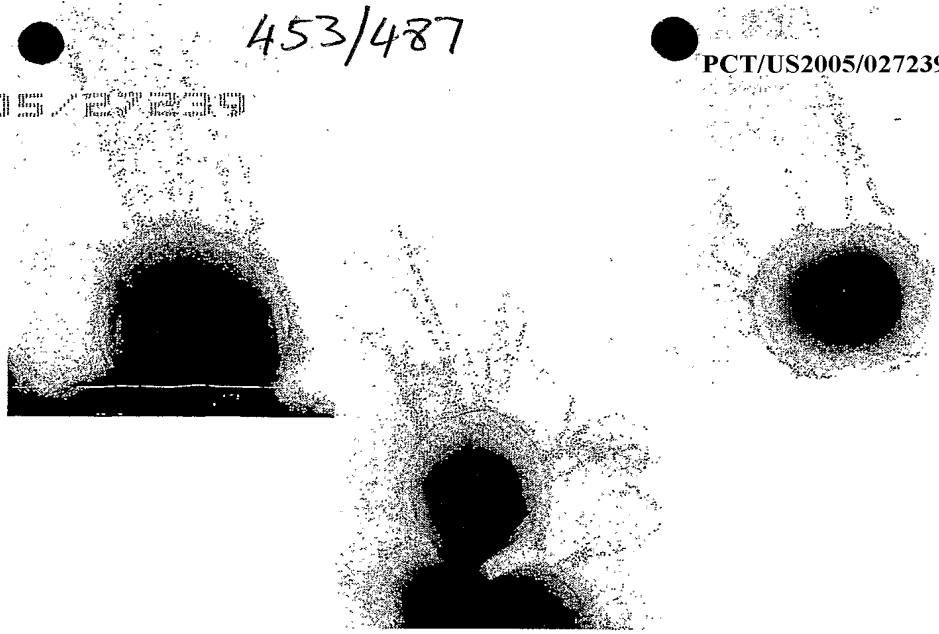

α 59

Figure 215

515 Δ 59

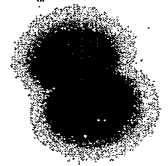

515 WT

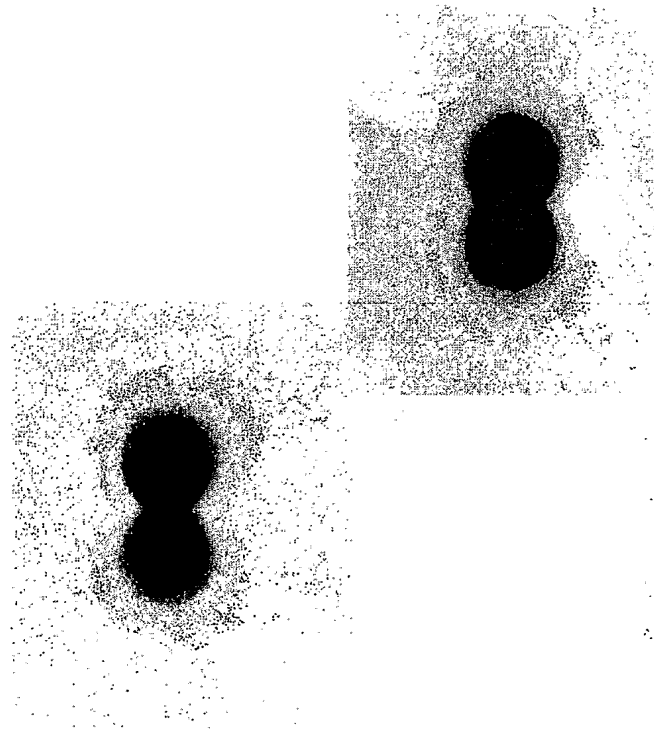

α 59

Figure 216

515 Δ 67p67



α 67

515 Δ 67

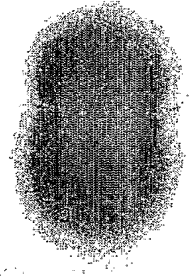

515 WT

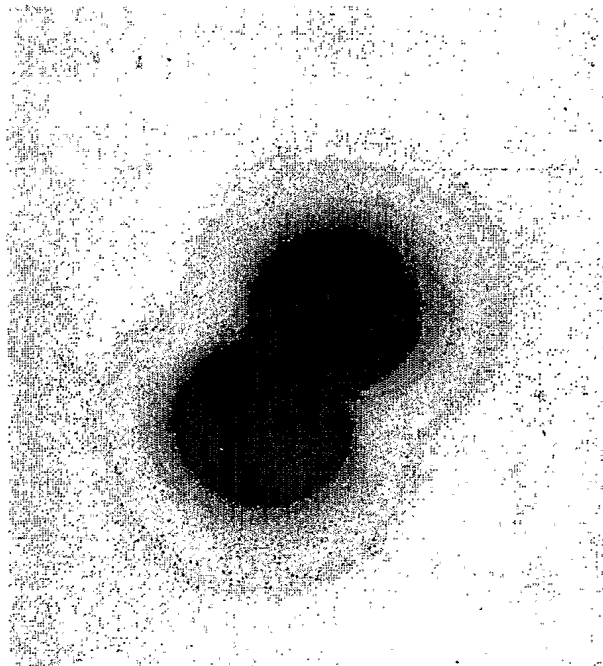

α 67

Figure 217

GBS 67 binds to fibronectin

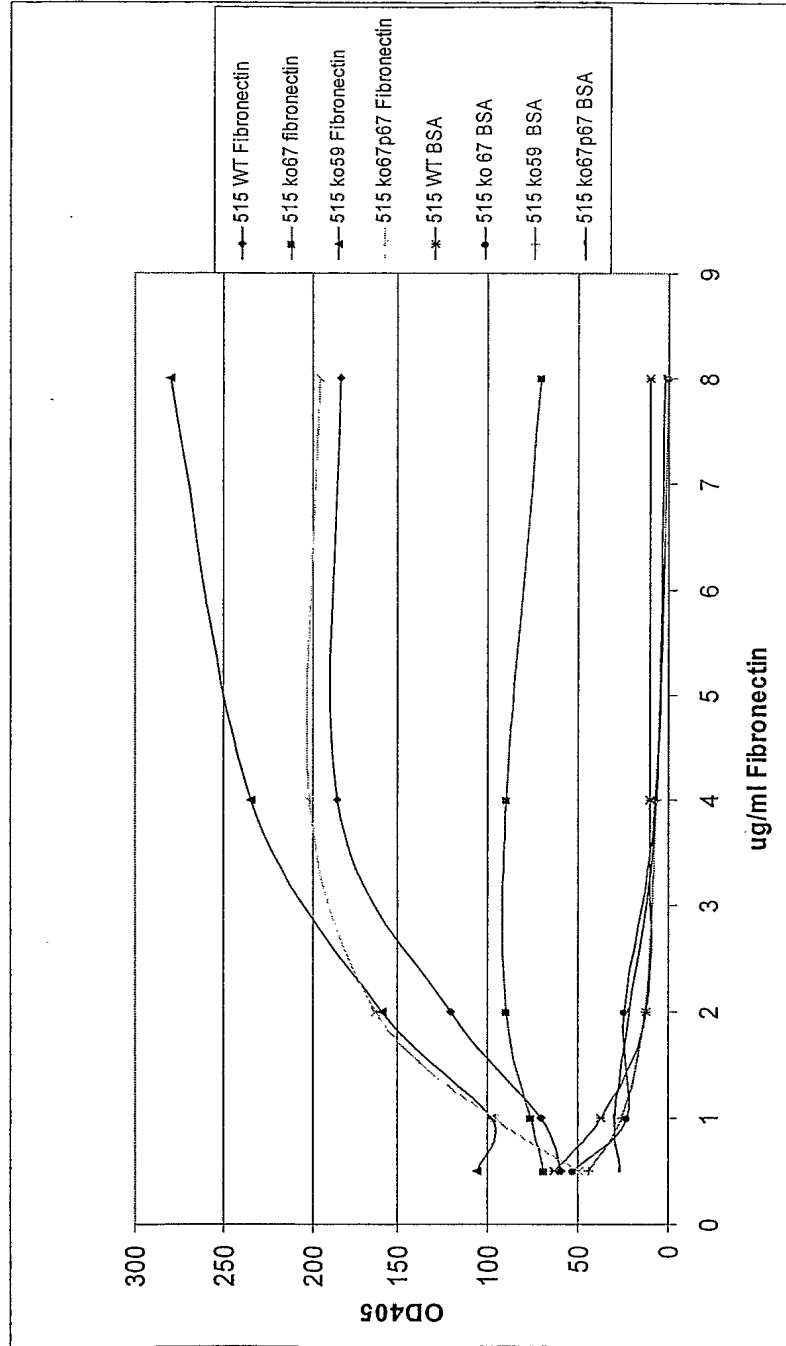
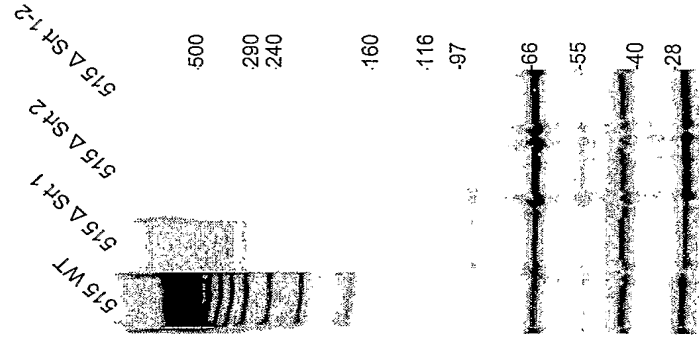
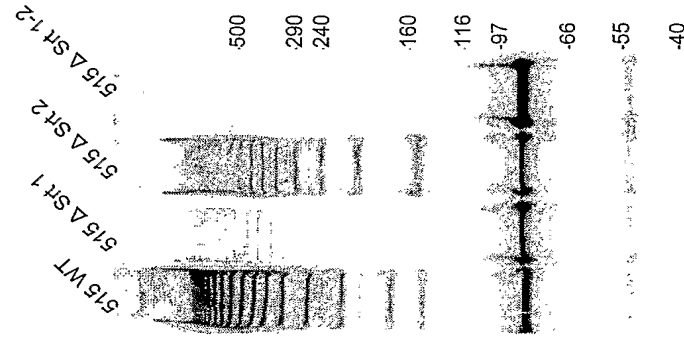

Figure 218



α -GBS 150



α -GBS 67



α -GBS 59

457/487

Figure 219

515 WT

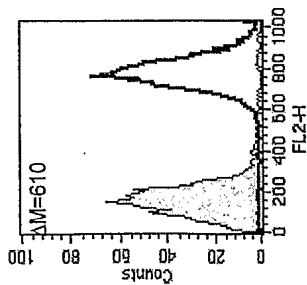

515 Δ Srt 1

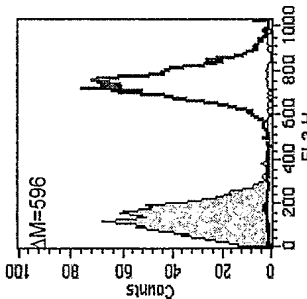

515 Δ Srt 2

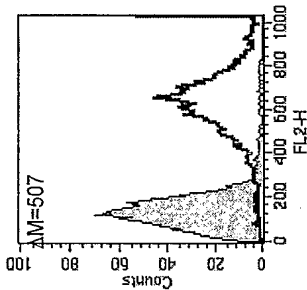

515 Δ Srt 1.2

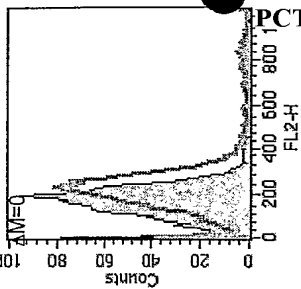
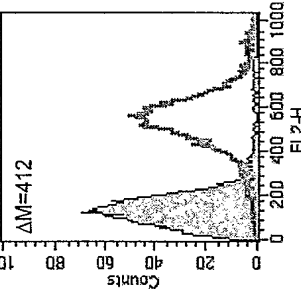
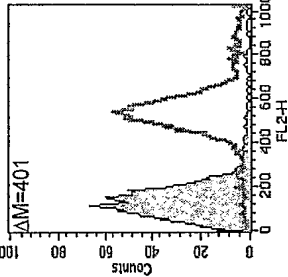
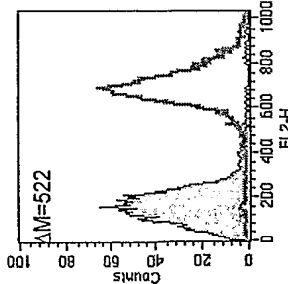
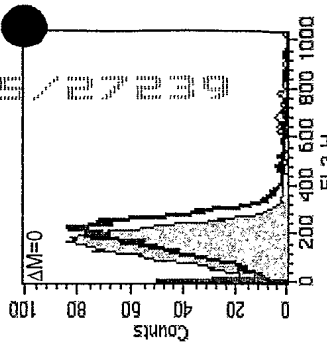

α59

α67

Figure 220

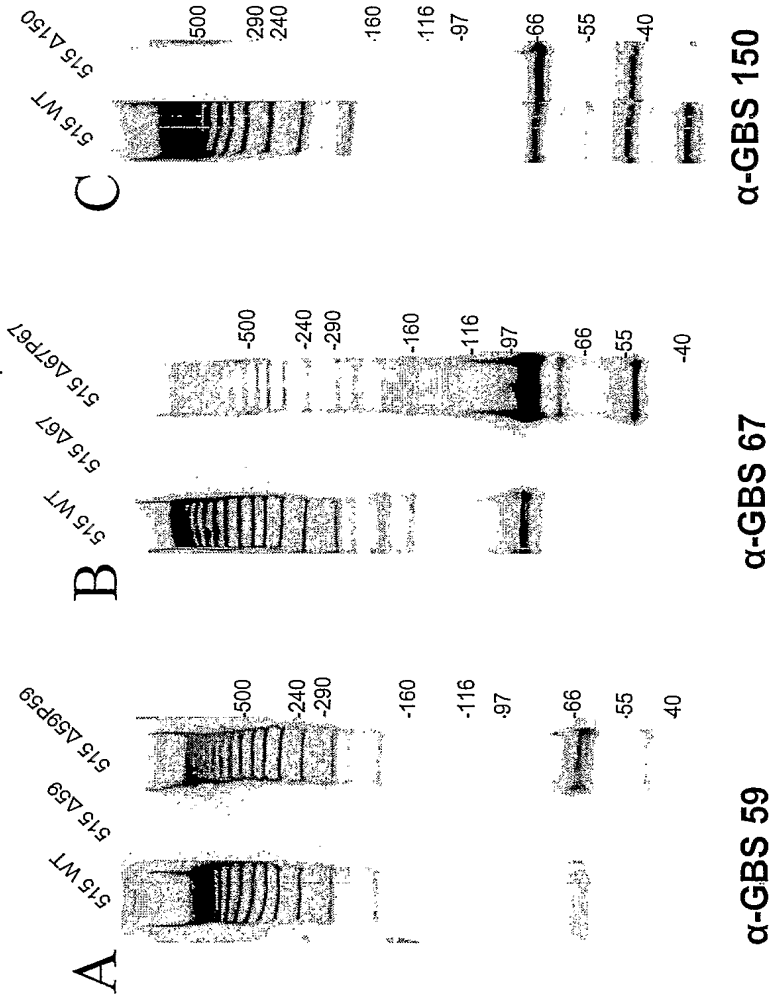

PCT/US05/27239 459/487

Figure 221

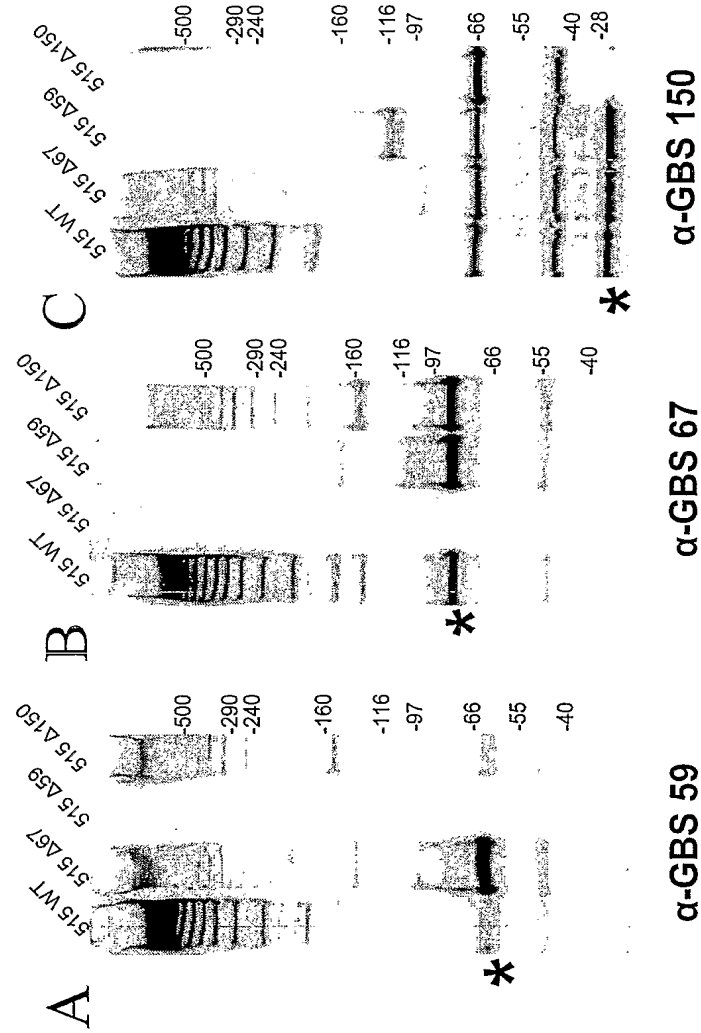
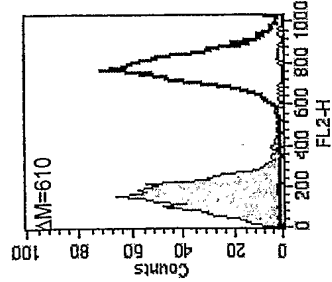
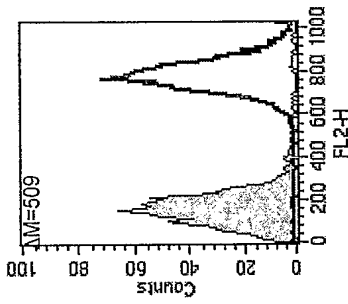

Figure 222

515 WT



515 Δ67



515 Δ59

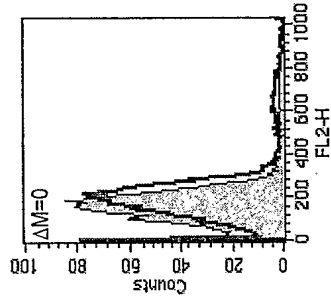

515 Δ59p59

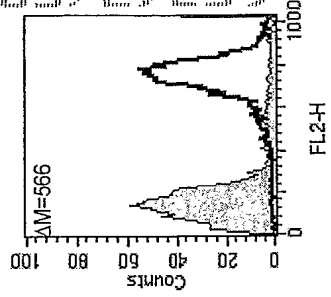

515 Δ522

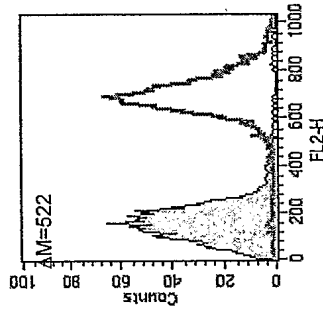

515 Δ520

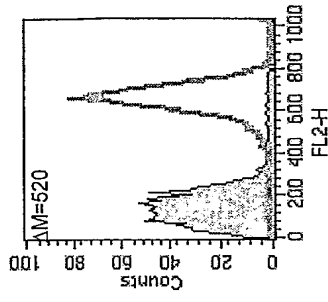
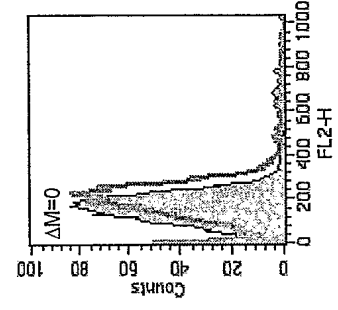

α59

α67

Summary WB

Figure 223

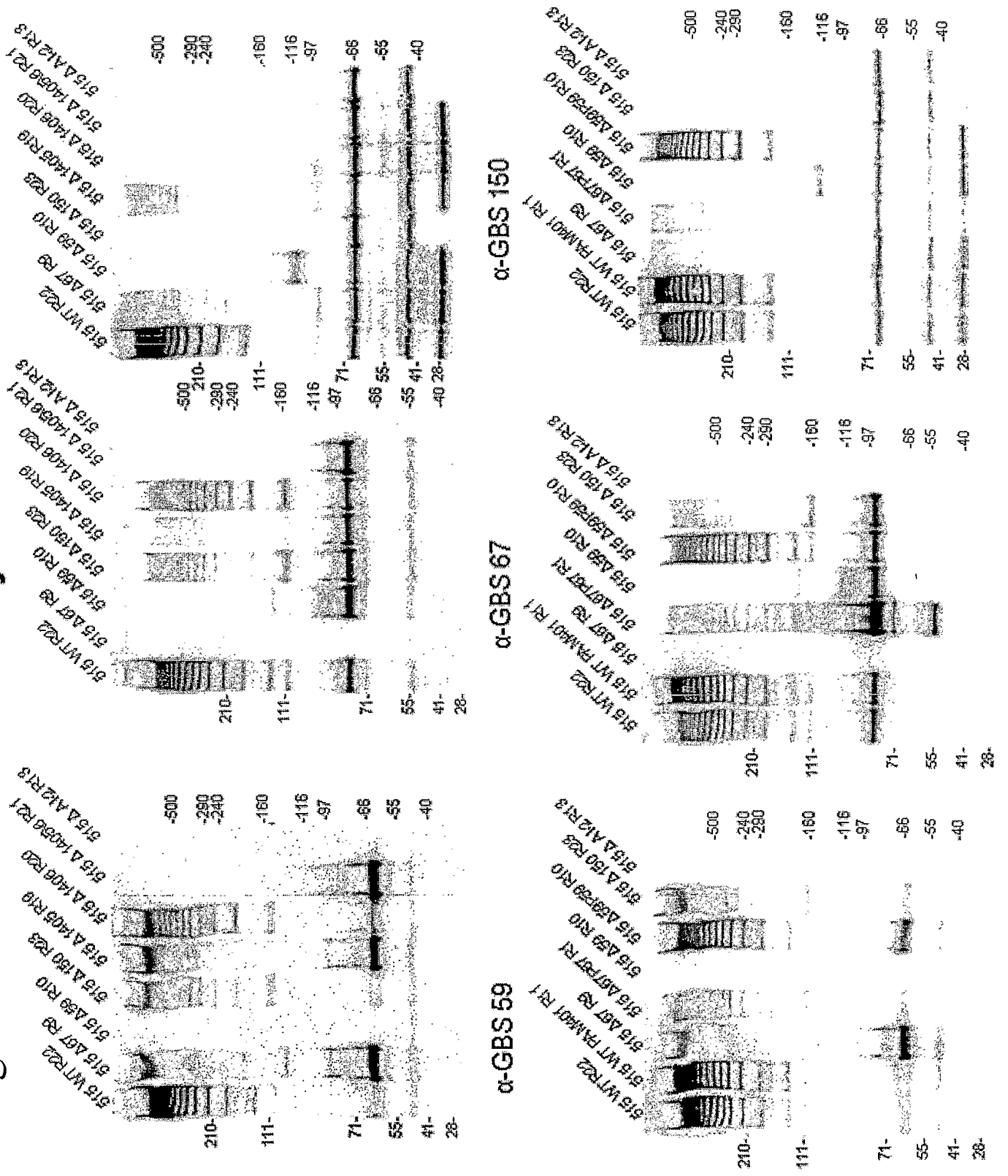

GBS strain % AA identity

7357b (Ib)	100
5518 (Ib)	100
5364 (V)	100
1999 (IV)	100
5408 (VIII)	98
coh31 (III)	98
d136c (III)	98
nem316 (III)	98

dk1 (Ia)	100
dk8 (Ia)	100
davis (Ia)	100
5551 (Ia)	100
2986 (Ia)	100
2110 (V)	100
2210 (IV)	100

18RS21 (II)	100
3050 (II)	100
2141 (II)	100
1998 (III)	100
2928 (VII)	99,9

2274 (IV)	99,9
2129 (Ib)	99,7
5401 (II)	99,8

GBS 59 allelic variants

cjb111 (V)
674 aa

515 (Ia)
675 aa

2603 (V)
705 aa

H36b (Ib)
693 aa

75%

48%

65%

Figure 224

Figure 225

GBS 59 is opsonic only against homologous strain

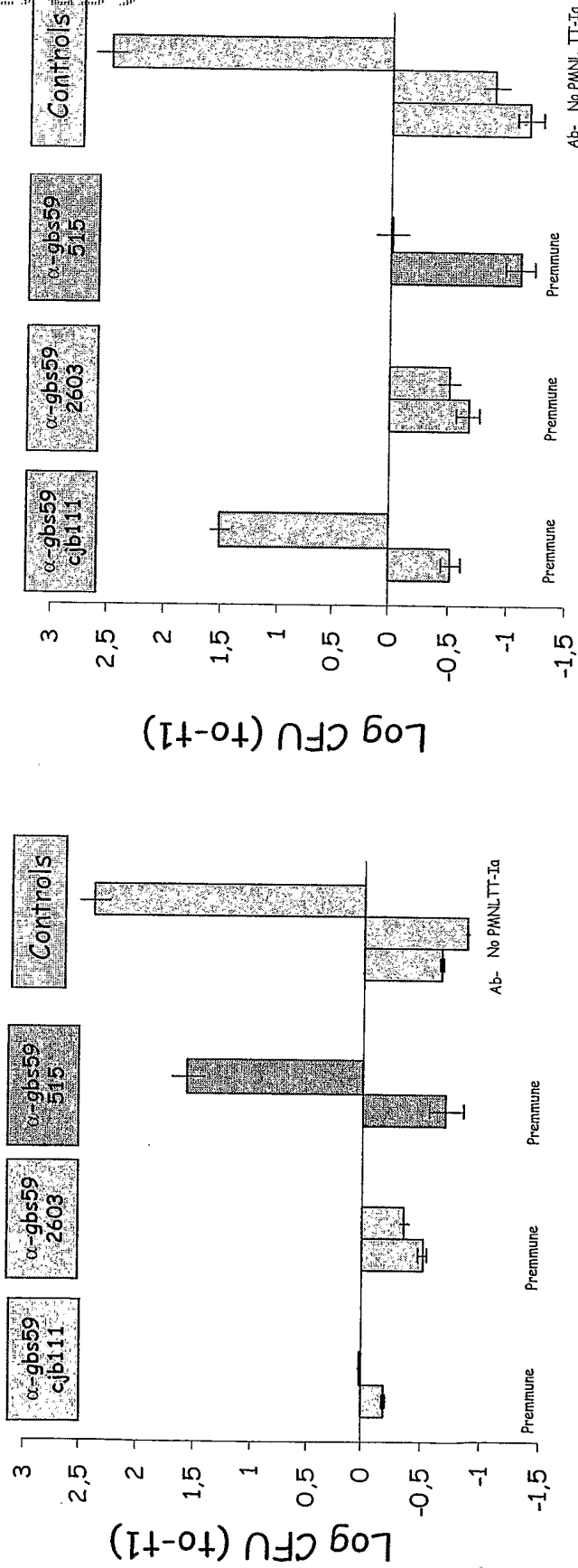

• 515 (Ia) GBS strain

• cjb111 (V) GBS strain

Figure 226 A

		GBS 59		
GBS strains	Type	PCR	FACS (a-cjb111)	FACS (a-2603)
DK1		+	565	
DK8		+	559	
Davis		+	577	
515	Ia	+	583	0
090		+	0	0
2986		+	443	
5551		+	524	
H36B		+	0	410
7357b-	Ib	+	596	
5518		+	190	
D136C		+	504	
COH31	III	+	505	
1998		+	59	510
18RS21		+	0	353
DK21		+	249	0
3050	II	+	0	570
5401		+	0	400
2141		+	0	371
CJB111		+	625	0
2603	V	+	0	73
5364		+	593	
2110		+	590	0
2274		+	0	400
1999	IV	+	594	
2210		+	636	
5408	VIII	+	537	
CJB110	NT	+	0	0
1169		+	227	0

GBS strains	Type	GBS 59		
		PCR	FACS (a-cjb111)	FACS (a-2603)
A909	Ia	-	22	
2177	Ib	-	75	
COH1		-	0	0
M732		-	0	
M781	III	-	17	
5376		-	60	
5435		-	55	
SMU071		-	0	
JM9130013	VIII	-	0	0

Figure 226 B

Figure 227 A

		FACS (D Mean)				
GBS strains	Type	GBS 80	GBS 104	GBS 67	GBS 322	GBS 59
DK1		0	0	478	153	565
DK8		0	0	475	213	559
Davis		0	0	430	86	577
515	Ia	0	0	409	227	583
090		0	0	0	0	0
A909		46	29	0	0	0
2986		0	0	397	0	443
5551		0	0	485	36	524
2177		477	355	66	323	0
H36B	Ib	0	0	444	105	410
7357b-		91	0	316	102	596
5518		31	0	162	0	190
COH1		305	226	0	130	0
D136C		40	40	406	460	504
COH31		0	0	273	479	505
M732	III	141	101	0	292	0
M781		111	136	0	224	0
1998		140	77	350	288	510
5376		165	156	0	76	0
5435		93	100	0	88	0
18RS21		0	0	103	471	353
DK21		0	0	331	342	249
3050	II	71	46	460	188	570
5401		75	28	618	135	400
2141		0	0	370	76	371
CJB111	V	365	236	481	58	625
2603		62	0	105	293	73
5364		454	281	394	463	593

2110		0	0	589	0	590
2274		123	62	484	161	400
1999	IV	0	389	453	55	594
2210		0	0	574	0	636
SMU071		556	393	74	170	0
JM9130013	VIII	587	436	72	133	0
5408		0	0	433	0	537
CJB110		0	0	245	587	0
1169	NT	0	0	443	213	227
D Mean > 200		6/37 (16%)	7/37 (19%)	24/37 (65%)	14/37 (38%)	24/37 (65%)

Figure 227B

Figure 228

GBS Strain	Type	FACS (Δ Mean)																Δ mean neg. control
		GBS 80		GBS 104		GBS 322		GBS 67		GBS 67		GBS 59		GBS 59		GBS 59		
		142-F		Mab		86		81	H36B		2603		CJ111		515			
cdc-1	II	114	95	0	0	122	122	360	341	422	403	92	73	254	235	306	287	19
cdc-2	IB	173	69	92	0	95	75	552	448	590	486	135	31	635	531	197	93	104
cdc-3	II	566	508	360	302	85	60	364	306	433	375	111	53	448	390	310	252	58
cdc-4	V	524	432	337	245	284	204	577	485	625	533	105	13	674	582	303	211	92
cdc-5	II	140	0	0	0	462	300	487	297	563	373	175	0	373	183	440	250	190
cdc-6	V	544	484	361	301	95	95	586	526	601	541	55	0	686	626	302	242	60
cdc-7	III	155	116	44	5	134	118	95	56	138	99	74	35	92	53	91	52	39
cdc-8	III	347	304	192	149	74	62	98	55	170	127	72	29	88	45	108	65	43
cdc-9	II	89	65	0	0	226	191	390	366	504	480	181	157	317	293	410	386	24
cdc-10	IA	46	24	0	0	152	152	494	472	531	509	43	21	16	0	48	26	22
cdc-11	IA	17	0	0	0	295	135	569	550	569	550	47	28	467	448	648	629	19
cdc-12	V	439	430	290	281	60	30	174	165	227	218	52	43	139	130	207	198	9
cdc-13	IA	33	0	0	0	216	146	469	436	469	436	100	67	361	328	571	538	33
cdc-14	III	78	68	10	0	213	191	50	40	85	75	38	28	69	59	67	57	10
cdc-15	III	119	53	24	0	108	98	48	0	127	61	89	23	105	39	100	34	66
cdc-16	V	363	335	177	149	310	270	70	42	127	99	48	20	130	102	128	100	28
cdc-17	III	160	0	163	0	408	248	377	217	410	250	441	281	359	199	167	7	160
cdc-18	III	49	28	0	0	239	218	34	13	36	15	16	0	49	28	56	35	21
cdc-19	III	182	101	0	0	361	280	310	229	312	231	384	303	220	139	0	0	81
cdc-20	V	348	304	203	159	380	336	166	122	211	167	114	70	232	188	128	84	44
cdc-21	II	222	132	83	0	150	60	331	241	336	246	0	0	420	330	59	0	90
cdc-22	IA	0	0	13	13	43	43	238	238	238	238	43	43	38	38	429	429	0
cdc-22 (9-6-05)		23	0	34	0	110	20	310	220	320	230	113	23	117	27	344	254	90
cdc-23	V	484	484	374	374	278	278	124	124	206	206	11	11	91	91	236	236	0
cdc-24	V	137	52	0	0	333	248	90	5	110	25	110	25	120	35	70	0	85
cdc-25	IA	0	0	0	0	351	190	530	370	565	405	495	335	442	282	625	465	160
cdc-26	II	117	2	0	0	185	70	210	95	285	170	30	0	175	60	210	95	115
cdc-27	III	323	95	34	0	498	270	346	118	406	178	424	196	314	86	64	0	228
cdc-28	V	150	92	20	0	132	74	462	404	505	447	0	0	526	468	78	20	58
cdc-29	IV	90	73	65	48	195	178	90	73	150	133	150	133	138	121	110	93	17
cdc-30	V	390	187	336	133	348	145	229	26	244	41	113	0	268	65	223	20	203
cdc-31	IA	22	0	68	0	306	182	368	244	386	262	126	2	248	124	426	302	124
cdc-32	IA	45	0	12	0	260	175	190	105	205	120	30	0	100	15	185	100	85
cdc-33	II	50	0	0	0	306	156	134	0	237	87	4	0	180	30	190	40	150
cdc-34	III	152	60	47	0	342	250	44	0	74	0	27	0	102	8	48	0	92
cdc-35	V	227	227	40	40	246	246	395	395	415	415	0	0	550	550	142	142	0
cdc-36	IB	25	15	8	0	30	20	154	144	174	164	33	23	222	212	20	10	10
cdc-37	III	168	53	61	0	361	246	82	0	133	18	83	0	132	17	75	0	115
cdc-38	II	140	14	30	0	338	212	124	0	198	72	158	32	138	12	104	0	126
cdc-39	II	126	0	0	0	316	148	466	298	514	346	438	270	184	16	34	0	168
cdc-40	V	420	366	214	160	22	0	103	49	162	108	90	36	209	155	192	138	54
cdc-41	II	146	31	15	0	380	265	330	215	425	310	140	25	280	165	315	200	115

Figure 229

Expected strain coverage

MIX GBS proteins

n. antigens FACS	vaccine options						
	80+104+67+59+322	w/o 59	w/o 322	w/o 104+322	w/o 59+322		
1	89%	80+104+67+322	80+104+67+59	80+67+59	80+104+67	80+67	80+59
2	74%	89%	80%	80%	79%	79%	74%
3	23%	51%	71%	64%	24%	16%	16%
		14%	17%	16%	13%		

- GBS 322 but not GBS 59 is important to increase strain coverage
- GBS 59 probably could be useful to increase the vaccine strength

Assumption:

- Protein antigens that are highly accessible to antibodies confer 100% protection with suitable adjuvants

PCT/US05/27239

Figure 230

GBS 59 opsonophagocytic activity is comparable to that of the four-protein mix

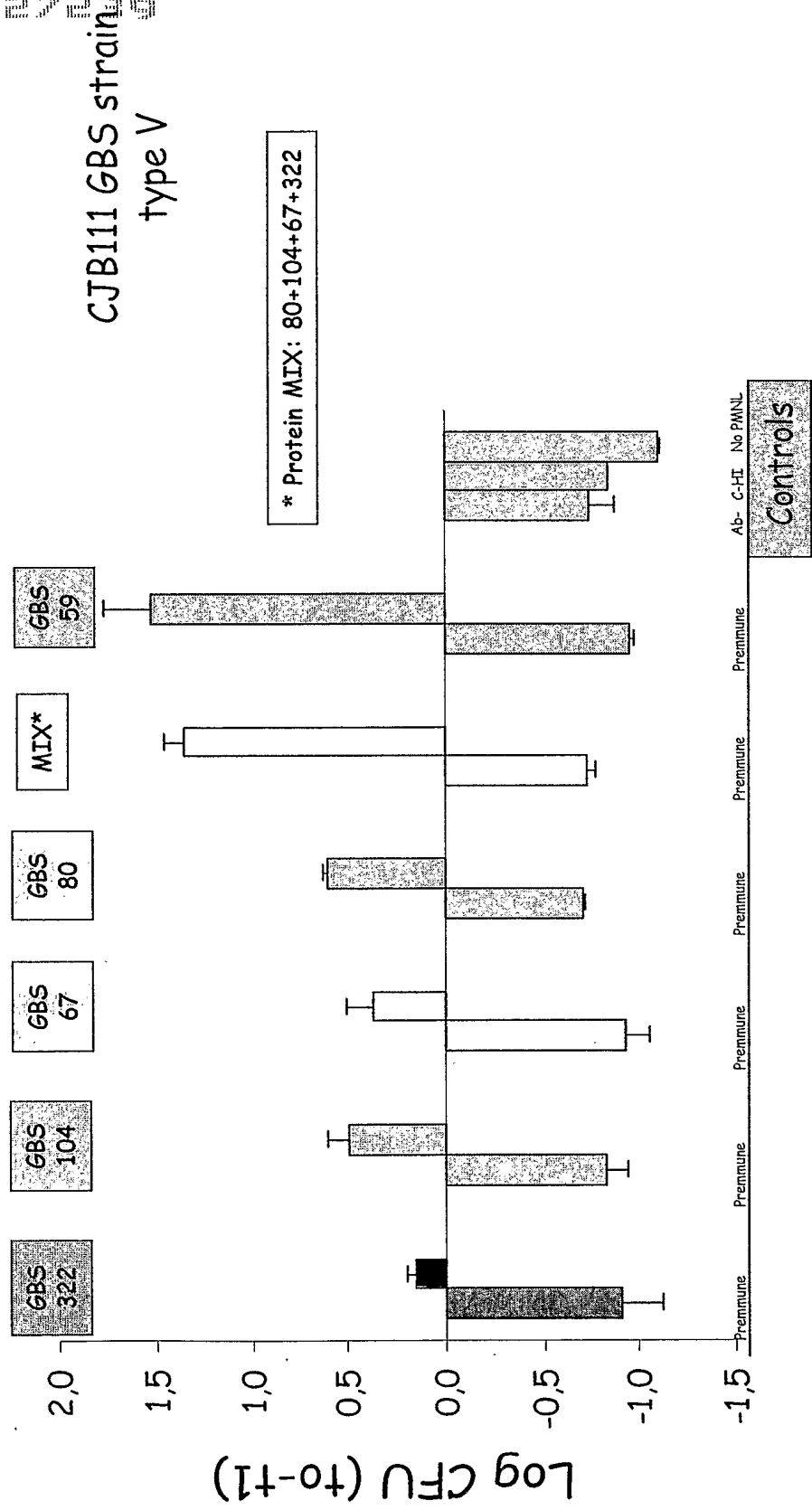

Figure 231

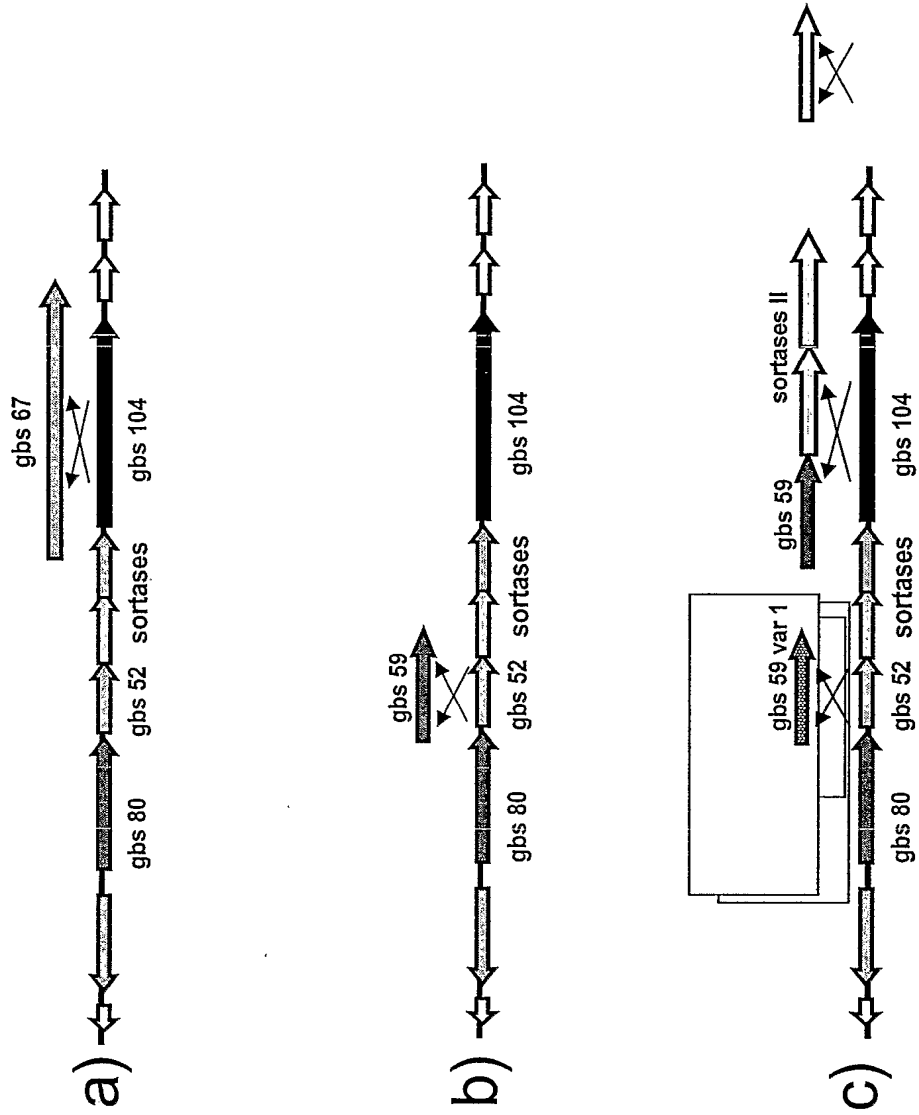

Figure 232

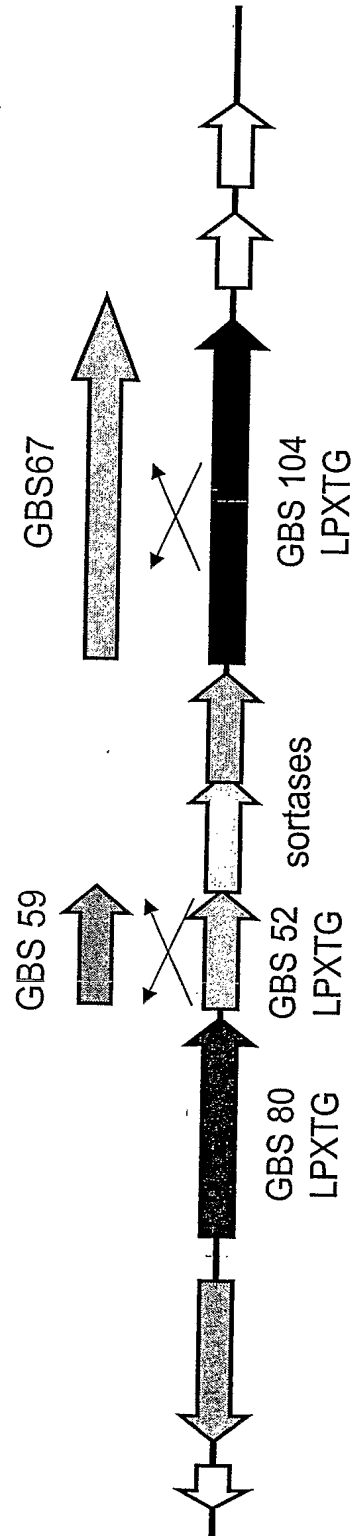

Figure 233

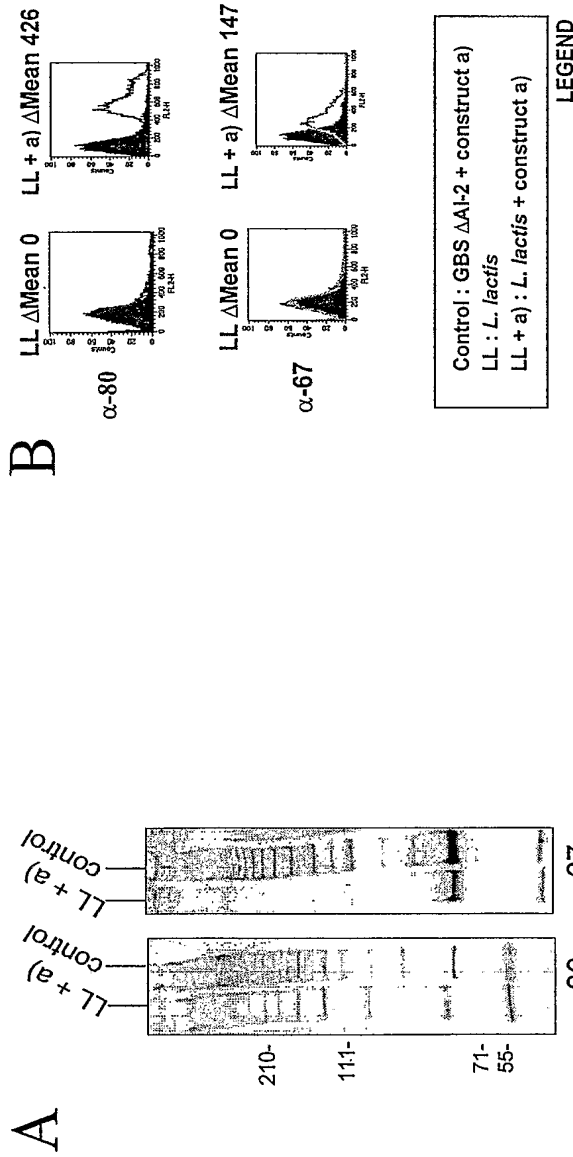
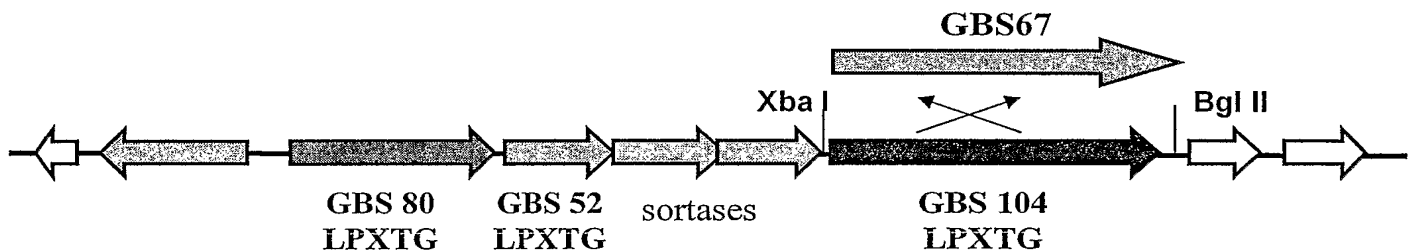

Figure 234 A

Introducing Heterologous Antigens into AI-1 pilus to Obtain Protection Across GBS Strains

1- Substitution of GBS 104 with GBS67 from Island II



Oligo GBS67pAMXbafor AGTCAGTCTCTAGACGGCACAAATAGGAGTTGTAAA
 Oligo GBS67pAMBglrev CACCTGTCATAGATCTTAAGAATACTAAAGCGCATAA

2- Substitution of GBS52 or 104 with:

- GBS 59 alleles 515 or CJB
- GBS 59 allele CJB111 + sortases island II
- GBS 59 allele 515 + GBS 59 CJB111 + sortases island II

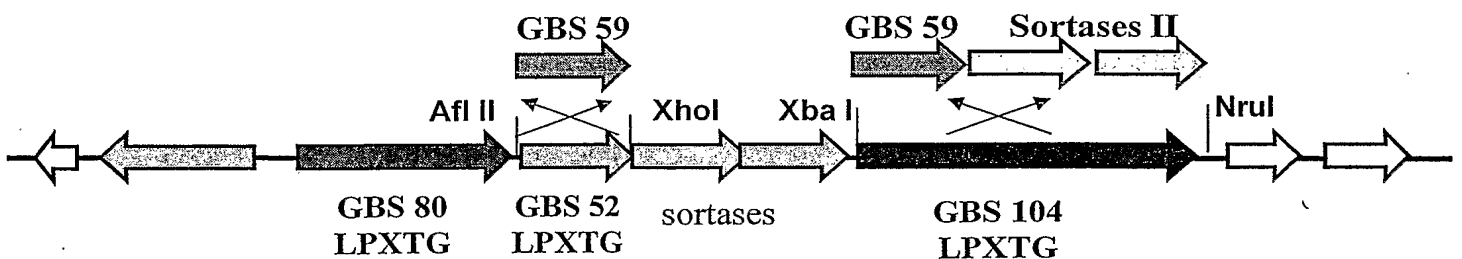

DETAILS:

a) Oligos to be used:

Oligo 59pAMAflfor1 AGTCAGTCCTTAAGCCGCATATTATTAATCATGTTG (allele 515)

Oligo 59pAMAflfor1 AGTCAGTCCTCGAGTTAACTTCCTCTGATTGACG (allele 515)

Oligo 59pAMAflfor2 AGTCAGTCCTTAAGAAGGAGTGGTGCTGCGGTAA (allele CJB111)

Oligo 59pAMXhorev2 AGTCAGTCCTCGAGTTAAGCTTCCTCTGATTGACG (allele CJB111)

PCT/US05/27239 475/487

b) Oligos to be used:

Oligo GBS59XbaF CTAGTGATATATCTAGAGAAAAAG

Oligo Sort59NruR CTAGCTAGTCGCGACTTTTTTCATTTTGGATTTCCCTTTC

Figure 234 B

3- Substitution of GBS104 with a fusion of GBS322-GBS67 to include GBS 322 into AI-1

- a) Construct 1: GBS67 complete sequence included
- b) Construct 2: Only part of GBS 67 was included (*deleted bold region*)

DETAILS:

a) Construct 1:

Legend:

Pink GBS322

Black GBS67

Black Bold: fragment of GBS67 eliminated in construct 2

Green PK motifs

Yellow E motifs

Red LPXTC

> gbs67-515 + 322

```

MRKYQKFSKILTLSLFCLSQIPLNTNVLGESTVPENGAKGKLVVKKTTDDQNKPLSKATFV
LKTTAHPESKIEKVTAELTGEATFDNLIPGDYTLSEETAPEGYKKTNQTWQVKVESNGKT
TIQNSGDKNSTIGQNQEELDKQYPPTGIYEDTKESYKLEHVKGSVPNGKSEAKAVNPYSS
EGEHIREIPEGTLSKRISVEGDLAHNKYKIELTVSGKTIVKPVDKQKPLETDTTWTARTVSEV
ADLVKQDNKSSYTVKYGDTLVISEAMSIDMNVLAKINNIADINLIYPETTLTVTYDQKSHIA
ISMKIETPATNAAGOTTATVDLKTNOVSVADOKVSLNRISEGMTPEAATTIVSPMKTYSSAF
ALKSKEVLAQEQAVSQAAANEQVSPAPVKSIITSEVPAAKEEVKPTQTSVVSQSTTVSPASV
AETPAPVAKVAPVVRTVAAPRVASVKVVTPIK VETGASPEHVSAPAVPVTTTSPATDSKLOAT
EVKSPVVAQKAPTATPVACPASTTNAVAHPENAGLQPHVAAYKERVASTYGVNEESTYRAC
DRGDHGKGLAVDFIVGTNQAALGNKVAQYSTQNMANNISYVWQOKEYSN
INSIYGPANTWINAMPDRGGVITANGYDHFVHVSFNK DWWFVLDNSMS
MNNDGPNFQRHNKAKKAAEALGTAVKDILGANS DNRVALVTYGS DIFDGRSVDVVKGFKE
DDKYYGLQTKFTIQTENYSHKQLTNNAEEIIRIPTEAPKAKWGSTTNGLTPEQQKEYYL
SKVGETFTMKAFMEADDILSQVNRNSQKIIVHVT DGVPTRSYAINNFKLGASYESQFEQM
KKNGYLNKSNFLLTDPDDIKMGESYFLFPLDSYQTQIISGNLQKLHYLDLNLNPKGI
IYRNGPVKEHGTPTKLYINSLKQKNYDIFNFGIDISGRQVYNEEYKKNQDGT FQKLKEE

```

PCT/US05/27239 477/487

AFKLS DGEITELMRSFSSKPEYYTPIVTSADTSNNEILSKIQQFETILTKENSIVNGTI
EDPMGDKINLQLGNGQILQPSDYTLQGN DGSVMKDG IATGGPNNDGGILKGVKLEYIGNK
LYVRGLNLGEGQKVTLYDVKLDDSFISNKFYDTN GR TTL NPK SEDPNTLRDFPIP KIRD
VREYPTITIKNEKKLGEIEFIKVDKDNNKLLLKGATFELQEFNEDYKLYLPIKNNNSKVV
TGENGKISYKDLKDGKYQLIEAVSPEDYQKITNKPILTFEVVKGSIKNIIAVNKQISEYH
EEGDKHLITNTHIPPKGI KICL KGILSFILIGGAMMSIAGGIYWKRYKKSSDMSIKK
D

Figure 234 C

b) Construct 2:

>gbs67-515 deleted+ 322

MRKYQKFSKILTLSLFCLSQIPLNTNVLGESTVPENGAAGKGLVVKKDDQNKPLSKATFV
LKTTHAPESKIEKVTAELTGEATFDNLIPGDYTLSEETAPEGYKKTNQWQVKVESNGKT
TIQNSGDKNSTIGQNQEELDKQYPPTGIYEDTKESYKLEHVKGSPNGKSEAKAVNPYS
SEGEHIREIPEGTLKRRISEVGDLAHNKYKIELTVSGKTIVKPVDKQKPLETDTTW
TARTVSEVKADLVKQDNKSSYTVKYGDTLVISEAMSIDMNVLAKINNIADINLIYPETTLTV
TYDQKSHATATSMKIETPATNAAGQTTATVBLKTNQVSVADQKVSLNITISEGMITPEAATT
VGRMKTYSSAPALKSKEVLAQEQAVSQAAANEQVFPAPVKSITSEVPAAKEEVKPTQTS
VSQSTTVGFAASVAETPAPVAKMAPVRTVAAPRVASMKVVTPEKVVETGASPEHVSAPAVF
VTTTSPATDSKLEQATEVKSVPVAQKAPTATPVAOPASTTNAVAHPENAGLQPHVAAYK
EKVASTYGVNFEPTYRACDPCDHGKCLAVDFMGTCNQAIGNKVAQYSTONMAANNISY
WQKKEYSNTNSIYGFANTWNAMPDRGGVTANHYDHYVHVSFNKGESYFLFPLDSYQQT
IISGNLQKLHYLDLNLNYPKGTIYRNGPVKEHGTPTKLYINSLKQKNYDIFNFGIDISGFRQ
VYNEEYKKNQDGTFFQKLKEEAFKLSGDEITELMRSFSSKPEYYTPIVTSADTSNNEILSKI
QQQFETILTKENSIVNGTIEDPMGDKINLQLGNGQILQPSDYTLQGNDGSVMKDGIAATGG
PNNDGGILKGVKLEYIGNKLYVRGLNLGEGQKVTLTYDVKLDDSFISNKFYDTNGRTTLN
PKSEDPNTRLRDFPIPKIRDVREYPTITIKNEKKLGEIEFIKVDKDNNKLLLKGATFELQEFNE
DYKLYLPIKNNNSKVVGTGENGKISYKDLKDGKYQLIEAVSPEDYQKITNKPILTFEVVKG
IKNIIAVNKQISEYHEEGDKHLITNTHIPPKGIRKGGKGIKILSIFILIGGAMMSIAGGIYWKRY
KKSSDMSIKKD

Oligos to be used:

Oligo GBS67pAMXbafor (vedi operone)

AGTCAGTCTCTAGACGGCACAAATAGGACTTGTAAA
XbaI

Oligo GBS67soe1rev

CGAAGCGGATATGCTTTTAAACGGCTTTTGTTCCTACT

Oligo GBS322soe2for

GACAAACAAAAGCCGTTAAGAACAGATACCAAGGTGGACAG

Oligo GBS322soe2rev1 (per costruito non deleto in 67)

GAGTACGAAGACAACATCTTCTGTTAAATGATACGGTGAAGC

Oligo GBS322soe2rev2 (per costruito deleto in 67)

TAAAAAGTAACTCTCCCCCTTGTGTTAAATGATACGGTGAAGC

PCT/US05/27239 479/487

Oligo fine67soe3for1 (per costruito non deleto in 67)

GACGATCATTAACAAAGATGTTGTCTTCGTACTIONGAT

Oligo fine67soe3for2 (per costruito non deleto in 67)

GACGATCATTAACAAAGGGGAGAGTTACTTTTTATTTC

Oligo GBS67pAMBglrev (vedi operone)

CACCTGTCATAGATCTTAAAGAATTACTAAACCCCAAAA

BgIII

Figure 234 D

- PCR Soe1: GBS67pAMXbafor + GBS67soe1rev 727 bp
- PCR Soe2 non del: GBS322soe2for + GBS322soe2rev1 1260 bp
- PCR Soe2 del: GBS322soe2for + GBS322soe2rev2 1260 bp
- PCR Soe3 non del: fine67soe3for1 + GBS67pAMBglrev 2061 bp
- PCR Soe3 del: fine67soe3for2 + GBS67pAMBglrev 1419 bp
- PCR Soe4 non del. PCR25: GBS67pAMXbafor + GBS67pAMBglrev 4000 bp
Substrato PCRSoe1, 2, 3 non del
- PCR Soe4 del, PCR26: GBS67pAMXbafor + GBS67pAMBglrev 3312 bp
Substrato PCRSoe1, 2, 3 del

4- Substitution of GBS 52 with a fusion of GBS322-GBS52 to include GBS 322 into AI-1

(same legend as for GBS67 derivatives)

- a) Construct 1: GBS52 complete sequenze included
- b) Construct 2: Only part of GBS 52 was included (*deleted bold region*)

DETAILS:

a) Construct 1:

>GBS322-52 senza delezione di 52 (B) PCR 24

```

MKMKNKVVLLTSTMAASLLSVASVQAOEITDTLWITARTVSEVKADLVKODNK
SSYTVKYGDITLSVISEAMSIDMNVLAKINNIADINLIYPETTLTVTYDQK
SHTATSMKIETPATNAAGQTTATVDLKTNOVSVADQKVSINLTISEGNTRE
WATTVSPMKTYSSAPALKSKEVLAQEQAVSQAAANEQVSPA
RVKSIITSEVPAAKEELVKPTQTSYSQSTTVSPASVAAETPAPVAKVAPVRTVAAPRVAS
MKVVTEKVVETGASPEHVSAPAVPVTTTSPATDSKLOATEVKSVPVAQKAP
EATPVAQAPASTTNAAHAFENAGLQEHVAAYKEKVASTYGVNEFSTYRAG
DFGDHGGKGLAVDFIVGCTNQALGNKVAQYSTQNMAANNISYVWQQOKEYSN
INSIYGPANTWNAMPDRCCVITANHYBHVHVSFNK HQLTIVHLEARDIDRPNPQL
EIAPEKGTPIEGVL YQLYQLKSTEDGDLAHWNSLTITELKKQAQQVFEA
TTNQQGKATFNQLPDGIYYGLAVKAGEKNRNVSAFLVDLSEDKVYIPKII
WSTGELDLLKVGVDGDTTKPLAGVVFELYEKNGRTPIRVKNGVHSQDIDA
AKHLETDSSGHIRISGLIHGDYVLEKBIETQSGYQIGQAETAVTIEKSKTV
    
```

WO 2006/078318

PCT/US2005/027239

PCT/US05/027239 481/487

TVTIENKKVPTPKVPSRGGI [REDACTED] QQAMALVIIGGILIALALRLLSKH
RKHQNKD

482/487

Figure 234 E

b) Construct 2:

>GBS322-52 (A) PCR 23

MKMNKKVLLTSTMAASLLSVASVQAQETDTTWTARTVSEVKADLVKQDNK
 SSYTVKYGDTLSVISEAMSIDMNVLAKINNIADINLIYFETTLTVTYDOK
 SHTATSMKIETPATNAAGQTTATVDLKTNOVSVADQVSLNTISEGMTPE
 VATTIVSPMKTYSAPALKSKEVLAQEQAVSQAAAANEQVSPA
 RVKQITSEVPAAKEEYKFTQTSVSOSTTVSPASVAAETPARVAKVAPVRTVAAPRVAS
 VKVYTPKMETGASPEIIVSAPAVPVTTTSPATDSKLOATEVKSVPVAQKAF
 IATPVAQPASTTNAVAHPENAGLOPHVAAVKEKVASTYGVNEFSTYRAG
 IPGDHCKGLAVDEIVGTNQAALGNKVAQYSTONMAANNISYVWQCKFYSN
 NSLYCPANTWNAMPDRCCVTANHYDHVHVSENK
 QGKATFNQLPDGIYYGLAVKAGEKNRNVSAFLVDLSEDKVIYPKII
 WSTGELDLLKVGVDGDTKKPLAGVVFELYEKNGRTPIRVKNQVHSQDIDA
 AKHLETDSGHIRISGLIHGDYVLKEIETQSGYQIGQAETAVTIEKSKTV
 TVTIENKKVPTPKVPSRGGLEKTCBQQAMALVIIGGILIALRLLSKH
 RKHQNKD

Oligos to be used:

Oligo 322Aflfor1

AGTCAGTCCTTAAGGATATTATAGTCTCGGACTA

Afl II

Oligo 52 soe1 forA

CACCGTATGATTTAACAACA CAAGGAAAGGCTACATTTAACC

Oligo 52 soe1 forB

CACCGTATGATTTAACAACA CATCAGTTGACGATTTTCATC

Oligo52 soe1revA

AAATGTAGCCTTTCCTTGTTTGTTAAATGATACGTCGAACC

Oligo52 soe1revB

AACAATCGTCAACTGATGTTTGTTAAATGATACGTCGAACC

Oligo 52Xhorev

AAGACCTCCTCGAGATGGCACTT

483/487

Xho I

PCR Soe1A: Oligo 322Aflfor1+ Oligo 52 soe1 revA 1370 bp

PCR Soe2A: Oligo52 soe1forA + Oligo 52Xhorev 520 bp

PCR Soe3A: Oligo 322Aflfor1 + Oligo 52Xhorev 1846 bp (con PCR Soe1A + PCR Soe2A)
(PCR23)

PCR Soe1B: Oligo 322Aflfor1+ Oligo 52 soe1 revB 1370 bp

PCR Soe2B: Oligo52 soe2forB + Oligo 52Xhorev 742 bp

PCR Soe3B: Oligo 322Aflfor1 + Oligo 52Xhorev 2068 bp (con PCR Soe1B + PCR Soe2B)
(PCR 24)

484/487

Figure 235

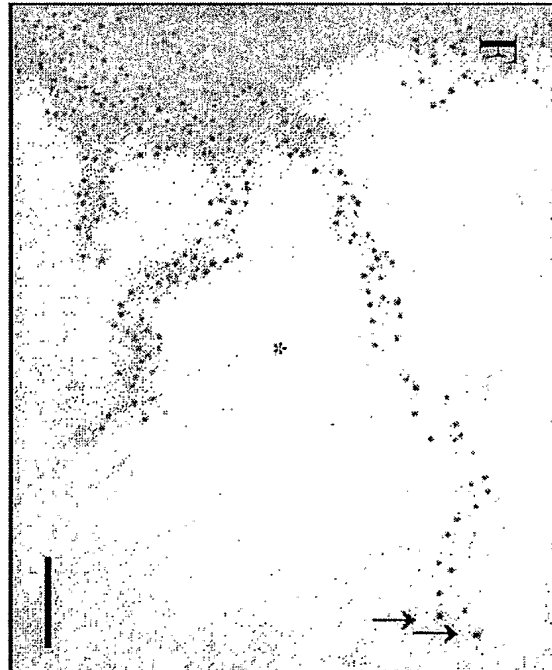

Figure 236



Strain variability - GBS67: 2 alleles

1 MRKYQKFSKILTLISLFLSLSQIPLANTNVLGSESTVPENGAKGLVVKKTDQ 50
 |||||
 1 NVIGSESTVPENGAKGLVVKKTDQ 25

51 NKPLSKATFVLTAKTAPESKIEKVTAEFTGEATFDNLIPGDYTLSEETAP 100
 |||||
 26 NKPLSKATFVLTAKTAPESKIEKVTAEFTGEATFDNLIPGDYTLSEETAP 75

101 EGYKKTQVQVKSNGKTTIQNSGDKNSITGQEQEELDKQYPTGIYE 150
 |||||
 76 EGYKKTQVQVKSNGKTTIQNSDDKKSIEQEQEELDKQYPLTGAYE 125

151 DTKESYKLEHVKGSVNGRSEAKAVNPYSSEGEHIRETPEGLSKRISV 200
 |||||
 126 DTKESYNLEHVKNSIPNGKLEAKAVNPYSSEGEHIREIQEGLSKRISV 175

201 GDLAHKKYELIYVSGKTIYKPYDKQKPLDVVFLDNSNANDGNFOR 250
 |||||
 176 NDLDHKKYELIYVSGKSIKINKDEPLDVVFLDNSNANNGKN... 222

251 HNKAKAAEALGTAVDIIGANSNRVALVTGSDIFDGRSDVYVKGFK 300
 |||||
 223 .NKAKAGAEVETIKDVLGANVENRAALVTGSDIFDGRVVKVKGFK 271

301 DDXYGLQTFQENYSHKQITNNAEIIKRIPEAKKAGSTINGL 350
 |||||
 272 .DPYYGLETSFTVQNDY SYKKFTWAADIKKIPKPEAKWGGTSLG 320

351 TPEQKYYLSKYGEFTKKAWEADDDILSQVNRNSQKLIHVHIDGVPTR 400
 |||||
 321 TPEKREYDLSKYGEFTKKAWEADDDILSSIQRSKRLIVHLDGVPTR 370

401 SYAINNEKLGASYSQFQKKNNGYLNKSNELLDDKPEDIKNGESYFLF 450
 |||||
 371 SYAINSVKGSYVQANQFERIKGKGYLDKNNYFLTDDPEKIKNGESYFLF 420

451 PDSYQTIISGNLQKHLHYLDLNLNYPKGTIYRNGFVKEHGFTPKLYINS 500
 |||||
 421 PDSYQTIISGNLQKHLHYLDLNLNYPKGTIYRNGFVREHGFTPKLYINS 470

501 LKQKNYDIFNFGIDISGFRQVYNEEYKKNQDGTFOKLEKFAFKLSDGEIT 550
 |||||
 471 LKQKNYDIFNFGIDISGFRQVYNEEYKKNQDGTFOKLEKFAFKLSDGEIT 520

551 ELMRSFSKPEYYTPIVTSADYSNNEILSKIQOQFEKILTKENSIVNGTI 600
 |||||
 521 ELMRSFSKPEYYTPIVTSADYSNNEILSKIQOQFEKILTKENSIVNGTI 570

601 EDPMGDKINLQNGNQTLPQSDYTLQGNDSVMDGIATGFPNNDGGILK 650
 |||||
 571 EDPMGDKINLHNGNQTLPQSDYTLQGNDSIMKDSIATGFPNNDGGILK 620

651 GVKLEYIGNKLYVRGLNIGEGQKVTLYDVKLDSDSFSNKFYDNGRFTTL 700
 |||||
 621 GVKLEYIGNKLYVRGLNIGEGQKVTLYDVKLDSDSFSNKFYDNGRFTTL 670

701 NPKSEDENTLRDFPIPKIRDVREYPTITIKNEKKGIEIEIKYDKONNKL 750
 |||||
 671 NPKSEEDTLRDFPIPKIRDVREYPTITIKNEKKGIEIEFTYDKONNKL 720

751 LLKGAFFELQEFNEDYKLYLPIKNNNSKVVTGNGKLSYKDLKDKGYQLI 800
 |||||
 721 LLKGAFFELQEFNEDYKLYLPIKNNNSKVVTGNGKLSYKDLKDKGYQLI 770

801 EAVSPEDYQKITNKPIITFEVVKSGIKNIIVANKQISEYHEEGDKHLITN 850
 |||||
 771 EAVSPDYQKITNKPIITFEVVKSGIQNIIVANKQISEYHEEGDKHLITN 820

851 THIPPKGIIIPMTGGKILLSFILLIGAMMSIAGGIYIWKRYKKSSDMSIKK 900
 |||||
 821 THIPPKGI..... 828

Differences
 between strains
 2603 and H36B
 (AA not matching/AA
 total and % of homology)

114 / 828 (87,1%)

485/487

Figure 237

Strain variability - GBS67 Allele I (2603)

Strain	Differences in comparison with 2603 (% of homology)
2603	-
18RS21	1/833 (99.9%)
CJB111	14/833 (98.3%)
515	2/833(99.8%)

Figure 238

Strain variability - GBS67 Allele II (H36b)

Strain	Differences in comparison with H36b (% of homology)	FACS (α -67 from 2603)
H36B	-	444
1169	10/823 (98.8%)	443
090	9/316 Stop codon (8G to 7G)	0
CJB110	11/824 (98.7%)	245

Figure 239

(19) World Intellectual Property Organization
International Bureau



(43) International Publication Date
27 July 2006 (27.07.2006)

PCT

(10) International Publication Number
WO 2006/078318 A3

(51) International Patent Classification:
A61K 39/02 (2006.01)

(21) International Application Number:
PCT/US2005/027239

(22) International Filing Date: 29 July 2005 (29.07.2005)

(25) Filing Language: English

(26) Publication Language: English

(30) Priority Data:

60/592,805	29 July 2004 (29.07.2004)	US
60/609,833	13 September 2004 (13.09.2004)	US
60/616,833	8 October 2004 (08.10.2004)	US
60/633,418	7 December 2004 (07.12.2004)	US
60/640,069	30 December 2004 (30.12.2004)	US
60/660,321	11 March 2005 (11.03.2005)	US
60/673,754	22 April 2005 (22.04.2005)	US
60/693,001	21 June 2005 (21.06.2005)	US
60/695,453	1 July 2005 (01.07.2005)	US
60/697,643	11 July 2005 (11.07.2005)	US

I-53100 Siena (IT). **RINAUDO, Daniela** [IT/IT]; **CHIRON VACCINES, 1**, Via Fiorentina, I-53100 Siena (IT). **MASIGNANI, Vega** [IT/IT]; **CHIRON VACCINES, 1**, Via Fiorentina, I-53100 Siena (IT). **BAROCCHI, Michelle** [IT/IT]; **CHIRON VACCINES, 1**, Via Fiorentina, I-53100 Siena (IT). **RAPPULOI, Rino** [IT/IT]; **CHIRON VACCINES, 1**, Via Fiorentina, I-53100 Siena (IT).

(74) Agent: **HALE, Rebecca, M.**; Novartis Vaccines and Diagnostics Inc., P.O. Box 8097, Emeryville, CA 94662-8097 (US).

(81) Designated States (unless otherwise indicated, for every kind of national protection available): AE, AG, AL, AM, AT, AU, AZ, BA, BB, BG, BR, BW, BY, BZ, CA, CH, CN, CO, CR, CU, CZ, DE, DK, DM, DZ, EC, EE, EG, ES, FI, GB, GD, GE, GH, GM, HR, HU, ID, IL, IN, IS, JP, KE, KG, KM, KP, KR, KZ, LC, LK, LR, LS, LT, LU, LV, MA, MD, MG, MK, MN, MW, MX, MZ, NA, NG, NI, NO, NZ, OM, PG, PH, PL, PT, RO, RU, SC, SD, SE, SG, SK, SL, SM, SY, TJ, TM, TN, TR, TT, TZ, UA, UG, US, UZ, VC, VN, YU, ZA, ZM, ZW.

(71) Applicant (for all designated States except US): **NOVARTIS VACCINES AND DIAGNOSTICS INC.** [US/US]; 4560 Horton Street, Emeryville, CA 9460-2916 (US).

(72) Inventors; and

(75) Inventors/Applicants (for US only): **TELFORD, John, L.** [IT/IT]; Chiron Vaccines, 1, Via Fiorentina Siena, I-Siena (IT). **GRANDI, Guido** [IT/IT]; **CHIRON VACCINES, 1**, Via Fiorentina, I-53100 Siena (IT). **LAUER, Peter** [US/US]; 1438 Milvia Street, Berkeley, CA 94709-1917 (US). **MORA, Marirosa** [IT/IT]; **CHIRON VACCINES, 1**, Via Fiorentina, I-53100 Siena (IT). **ROS, Immaculada, Margarit, Y.** [IT/IT]; **CHIRON VACCINES, 1**, Via Fiorentina, I-53100 Siena (IT). **MAIONE, Domenico** [IT/IT]; **CHIRON VACCINES, 1**, Via Fiorentina, I-53100 Siena (IT). **BENSI, Giuliano** [IT/IT]; **CHIRON VACCINES, 1**, Via Fiorentina,

(84) Designated States (unless otherwise indicated, for every kind of regional protection available): ARIPO (BW, GH, GM, KE, LS, MW, MZ, NA, SD, SL, SZ, TZ, UG, ZM, ZW), Eurasian (AM, AZ, BY, KG, KZ, MD, RU, TJ, TM), European (AT, BE, BG, CH, CY, CZ, DE, DK, EE, ES, FI, FR, GB, GR, HU, IE, IS, IT, LT, LU, LV, MC, NL, PL, PT, RO, SE, SI, SK, TR), OAPI (BF, BJ, CF, CG, CI, CM, GA, GN, GQ, GW, ML, MR, NE, SN, TD, TG).

Published:

- with international search report
- before the expiration of the time limit for amending the claims and to be republished in the event of receipt of amendments

(88) Date of publication of the international search report:
30 October 2008

(54) Title: IMMUNOGENIC COMPOSITIONS FOR GRAM POSITIVE BACTERIA SUCH AS STREPTOCOCCUS AGALACTIAE

(57) Abstract: The invention relates to the identification of a new adhesin islands within the genomes of several Group A and Group B Streptococcus serotypes and isolates. The adhesin islands are thought to encode surface proteins which are important in the bacteria's virulence. Thus, the adhesin island proteins of the invention may be used in immunogenic compositions for prophylactic or therapeutic immunization against GAS or GBS infection. For example, the invention may include an immunogenic composition comprising one or more of the discovered adhesin island proteins.



WO 2006/078318 A3

INTERNATIONAL SEARCH REPORT

International application No.

PCT/US05/27239

A. CLASSIFICATION OF SUBJECT MATTER
 IPC: **A61K 39/02(2006.01)**

 USPC: **424/190.1**
 According to International Patent Classification (IPC) or to both national classification and IPC

B. FIELDS SEARCHED

Minimum documentation searched (classification system followed by classification symbols)
 U.S. : 424/190.1

Documentation searched other than minimum documentation to the extent that such documents are included in the fields searched

Electronic data base consulted during the international search (name of data base and, where practicable, search terms used)
 MEDLINE, BIOSIS, HCAPLUS, EMBASE, DERWENT, PUBLISHED APPLICATIONS AND ISSUED PATENTS.

C. DOCUMENTS CONSIDERED TO BE RELEVANT

Category *	Citation of document, with indication, where appropriate, of the relevant passages	Relevant to claim No.
X	WO 02/34771 A2 (TELFORD et al) 02 May 2002 (02.05.2002), see pages 1411 and 3057. (only the relevant pages provided)	1-7 and 17-24
X	LARSSON et al. Protection against experimental infection with group B streptococcus by immunization with a bivalent protein vaccine. Vaccine. February 1999, Vol. 17, No. 5, pages 454-458.	1-7 and 17-24

Further documents are listed in the continuation of Box C. See patent family annex.

* Special categories of cited documents:		
"A" document defining the general state of the art which is not considered to be of particular relevance	"T"	later document published after the international filing date or priority date and not in conflict with the application but cited to understand the principle or theory underlying the invention
"E" earlier application or patent published on or after the international filing date	"X"	document of particular relevance; the claimed invention cannot be considered novel or cannot be considered to involve an inventive step when the document is taken alone
"L" document which may throw doubts on priority claim(s) or which is cited to establish the publication date of another citation or other special reason (as specified)	"Y"	document of particular relevance; the claimed invention cannot be considered to involve an inventive step when the document is combined with one or more other such documents, such combination being obvious to a person skilled in the art
"O" document referring to an oral disclosure, use, exhibition or other means		
"P" document published prior to the international filing date but later than the priority date claimed	"&"	document member of the same patent family

Date of the actual completion of the international search 21 May 2008 (21.05.2008)	Date of mailing of the international search report 25 AUG 2008
Name and mailing address of the ISA/US Mail Stop PCT, Attn: ISA/US Commissioner for Patents P.O. Box 1450 Alexandria, Virginia 22313-1450 Facsimile No. (571) 273-3201	Authorized officer PADMA v. BASKAR <i>J. Roberts for</i> Telephone No. 571-272-1600

INTERNATIONAL SEARCH REPORT

International application No.

PCT/US05/27239

Box No. II Observations where certain claims were found unsearchable (Continuation of item 2 of first sheet)

This international search report has not been established in respect of certain claims under Article 17(2)(a) for the following reasons:

1. Claims Nos.:
because they relate to subject matter not required to be searched by this Authority, namely:

2. Claims Nos.:
because they relate to parts of the international application that do not comply with the prescribed requirements to such an extent that no meaningful international search can be carried out, specifically:

3. Claims Nos.:
because they are dependent claims and are not drafted in accordance with the second and third sentences of Rule 6.4(a).

Box No. III Observations where unity of invention is lacking (Continuation of item 3 of first sheet)

This International Searching Authority found multiple inventions in this international application, as follows:
Please See Continuation Sheet

1. As all required additional search fees were timely paid by the applicant, this international search report covers all searchable claims.
2. As all searchable claims could be searched without effort justifying additional fees, this Authority did not invite payment of any additional fees.
3. As only some of the required additional search fees were timely paid by the applicant, this international search report covers only those claims for which fees were paid, specifically claims Nos.: 1-7 and 17-24

4. No required additional search fees were timely paid by the applicant. Consequently, this international search report is restricted to the invention first mentioned in the claims; it is covered by claims Nos.:

- Remark on Protest**
- The additional search fees were accompanied by the applicant's protest and, where applicable, the payment of a protest fee.
 - The additional search fees were accompanied by the applicant's protest but the applicable protest fee was not paid within the time limit specified in the invitation.
 - No protest accompanied the payment of additional search fees.

INTERNATIONAL SEARCH REPORT

International application No.
PCT/US05/27239

BOX III. OBSERVATIONS WHERE UNITY OF INVENTION IS LACKING

1. This application contains the following inventions or groups of inventions which are not so linked as to form a single general inventive concept under PCT Rule 13.1. In order for all inventions to be examined, the appropriate additional examination fees must be paid.

Group I, claim 1 -7 (in part) drawn to an immunogenic composition comprising a purified Group B Streptococcus adhesion island polypeptide.

Further species election to one composition comprising GBS AI -1 or GBS AI -2 required (see paragraph # 3).

Group II, claims 8-16 (in part) drawn to an immunogenic composition comprising a purified gram positive adhesion island polypeptide.

Further species election to one composition comprising one bacteria and one GAS AI -1, GAS AI -2, GAS AI -3 and GAS AI -4 required (see paragraph # 3).

Group III, claims 17-24 (in part) drawn to an immunogenic composition comprising a first and second purified Group B Streptococcus adhesion island polypeptide.

Further species election to one combination of first and second polypeptide (see paragraph # 3).

Group IV, claims 25-34 (in part) drawn to an immunogenic composition comprising a first and second gram positive GAS AI -adhesion island polypeptide.

Further species election to one combination of first and second polypeptide (see paragraph # 3).

Group V, claims 35-39 and 40 (in part) drawn to a modified gram positive bacterium and a method of manufacturing adhesion island antigen

Further species election to one modified gram positive bacterium required (see paragraph # 3).

Group I is directed to an immunogenic composition comprising polypeptide GBS AI -1 or GBS AI -2 whereas Group II is drawn to immunogenic composition comprising gram positive bacterial adhesion polypeptides GAS AI -1, GAS AI -2, GAS AI -3 and GAS AI -4. These inventions are deemed to lack unity of invention because they are not so linked as to form a single general inventive concept under PCT Rule 13.1 because these two compositions do not share a common structure, property and function as group I contains GBS polypeptide where as group II comprises GAS polypeptides. Group III and Group IV are also drawn to compositions as group III comprises combination of two polypeptides from GBS that shares no common structure, property and function with Group IV as it comprises GAS polypeptide and thus do not share a single inventive concept. Thus these inventions are deemed to lack unity of invention because they are not so linked as to form a single general inventive concept under PCT Rule 13.1 Group V is drawn to a modified bacterium from GBS, GAS and non-pathogenic gram positive bacterium comprising expressing polypeptide GBS- AI -1 or GBS-AI-2 and not share a single inventive concept from other four groups as the composition contains polypeptides which does not share a common structure, property and function.

INTERNATIONAL SEARCH REPORT

International application No.
PCT/US05/27239

2. This application contains claims directed to more than one species of the generic invention. These species are deemed to lack unity of invention because they are not so linked as to form a single general inventive concept under PCT Rule 13.1. In order for more than one species to be examined, the appropriate additional examination fees must be paid. The species are as follows:

3 Group I species: GBS AI -1 80, 104, 52, 59, 67, 150, 01521, 01523, 01524 or GBS AI -2

Group II species: GAS AI -1, GAS AI -2, GAS AI -3 and GAS AI -4.

Group III species: Any combination of first and second polypeptide from GBS AI -1 80, 104, 52, 59, 67, 150, 01521, 01523, 01524, GBS AI -2.

Group IV species: Any combination of first and second polypeptide from GAS AI -1, GAS AI -2, GAS AI -3 and GAS AI -4

Group V species: Modified gram-positive bacterium or non pathogenic bacterium expressing GBS AI -1 80, 104, 52, 59, 67, 150, 01521, 01523, 01524, GBS AI -2, GAS AI -1, GAS AI -2, GAS AI -3 and GAS AI -4

The inventions listed as Groups 1-5 do not relate to a single general inventive concept under PCT Rule 13.1 because, under PCT Rule 13.2, they lack the same or corresponding special technical features for the following reasons:

The technical feature of linking groups appears to be that they are all related to immunogenic compositions comprising adhesion peptides methods of making adhesion peptide.

However, Beckmann et al Infection and Immunity, June 2002, p. 2869-2876, Vol. 70, No. 6 disclose an immunogenic composition comprising adhesion oligomeric polypeptide (see page 2871, left column last paragraph through right column and figure 3) As this polypeptide binds to fibrinogen it is an adhesion immunogen. Therefore, the technical feature of linking groups 1-5 does not constitute a special technical feature as defined by PCT Rule 13.2, as it does not define a contribution over the prior art and hence unity of invention is lacking.

The special technical feature of Groups 1-5 is considered to be immunogenic compositions comprising polypeptides that share no common structure, property and function and thus do not share the same or a corresponding technical feature.

Accordingly, Groups 1-5 are not so linked by the same or a corresponding special technical feature as to form a single general inventive concept.

The claimed species GBS AI -1 80, 104, 52, 59, 67, 150, 01521, 01523, 01524, GBS AI -2; GAS AI -1, GAS AI -2, GAS AI -3 and GAS AI -4 have no common structure and thus are not linked by the same or a corresponding special technical feature so as to form a single general inventive concept under Rule 13.1. Hence, unity is lacking among species.